

KAJA TYP 602

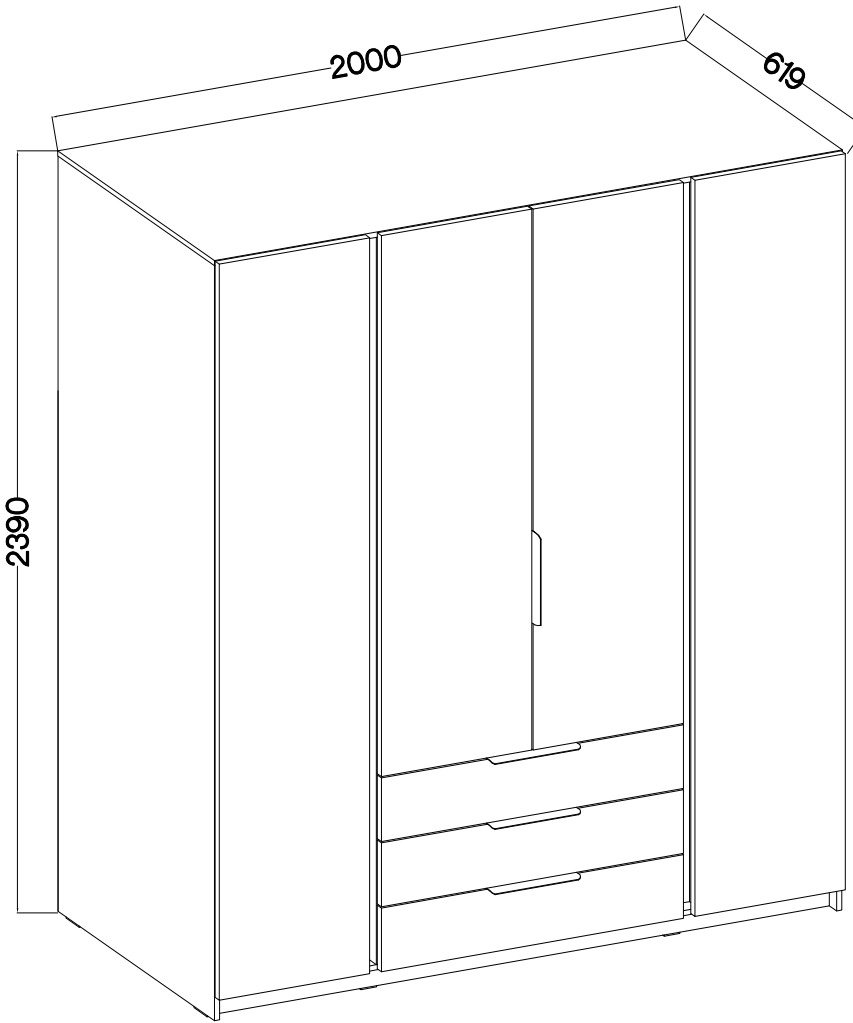

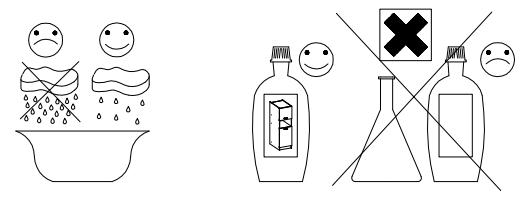

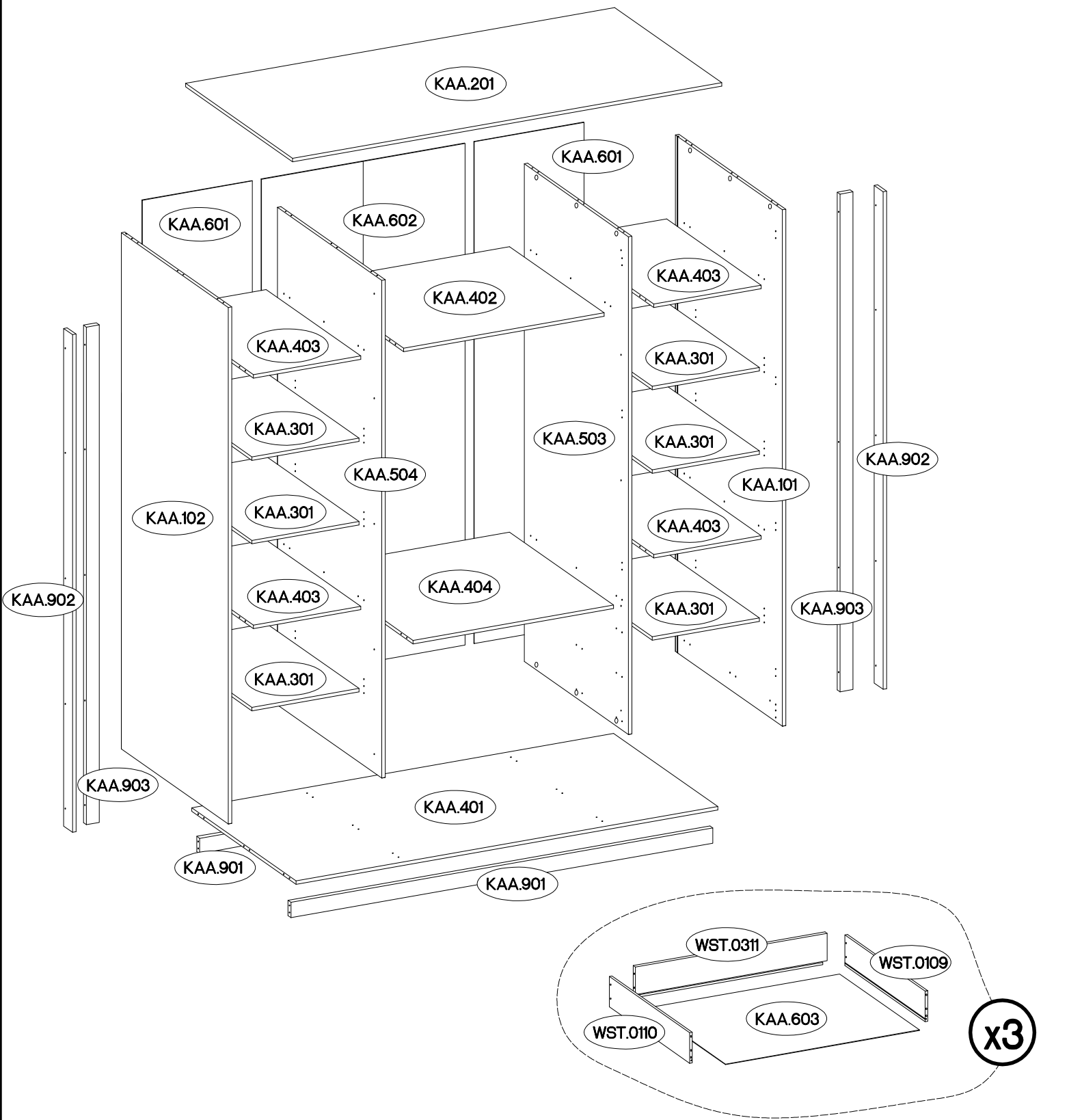

OPTION
15x15-L=2275mm

J58
1

 A	 A2	 B	 B1	 B2	 C	 C5	 D2	 D4	 E	 E1	 F22	 HG	 L	[CD] l11
60	4	4	20	12	60	6	54	6	42	24	8	14	3	
 J2	 J3	 J17	 K34	 L	 L2	 L19	 M2	 O	 O7	 P5	 P7	 P12	 S	
1	24	2	3	34	24	2	24	1	2	40	66	2	4	



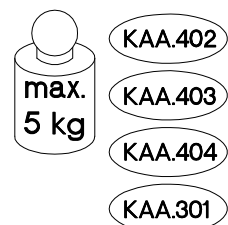
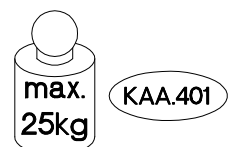

	Ersatzteil Nummer	Dimension
	KAA.402	934x530x16
	KAA.404	934x583x16
	KAA.301 x6	499x520x16
	KAA.603 x3	904x447x2,5
	WST.0109 x3	450x140x12
	WST.0110	450x140x12
	WST.0311 x3	894x140x12
	KAA.503	2283x584x16
	KAA.504	2283x584x16
	KAA.901 x2	1966x70x16
	KAA.902 x2	2283x50x16
	KAA.903 x2	2283x60x12

	Ersatzteil Nummer	Dimension
	KAA.101	2369x599x16
	KAA.102	2369x599x16
	KAA.601 x2	2302x512x2,5
	KAA.602	2302x949x2,5
	KAA.201	2000x600x16
	KAA.401	1966x585x16
	KAA.403 x4	500x530x16

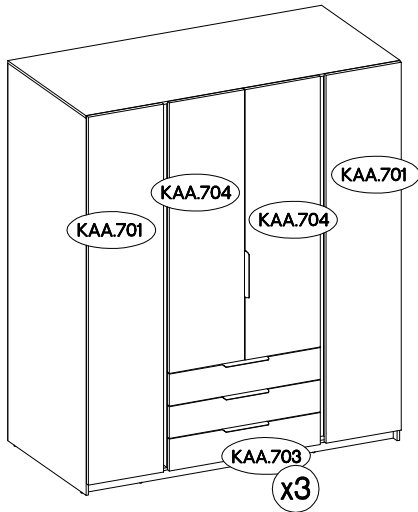

OPTION



	Ersatzteil Nummer	Dimension
	KAA.701 x2	2309x479x16
	KAA.704 x2	1697x479x16
	KAA.703 x3	962x200x16

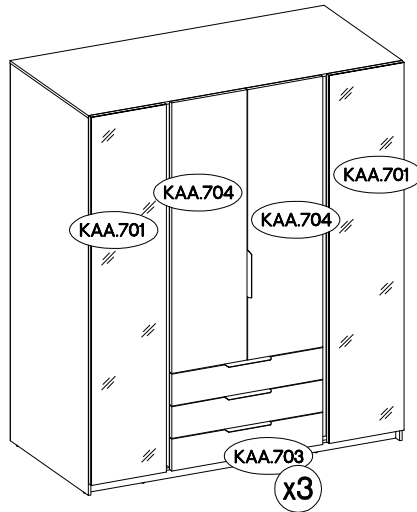

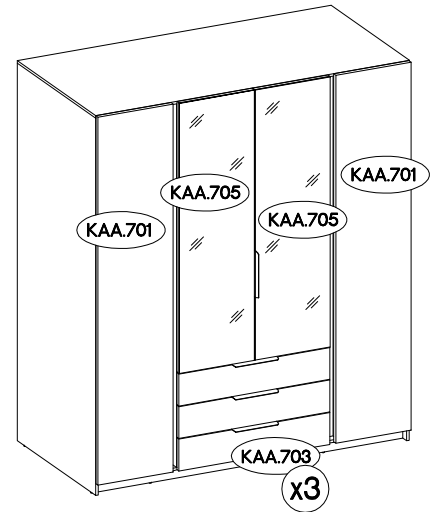

	Ersatzteil Nummer	Dimension
	KAA.702 x2	2309x479x19
	KAA.704 x2	1697x479x16
	KAA.703 x3	962x200x16



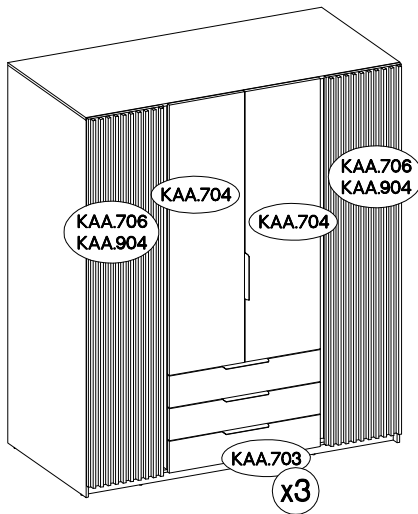

	Ersatzteil Nummer	Dimension
	KAA.701 x2	2309x479x16
	KAA.705 x2	1697x479x19
	KAA.703 x3	962x200x16

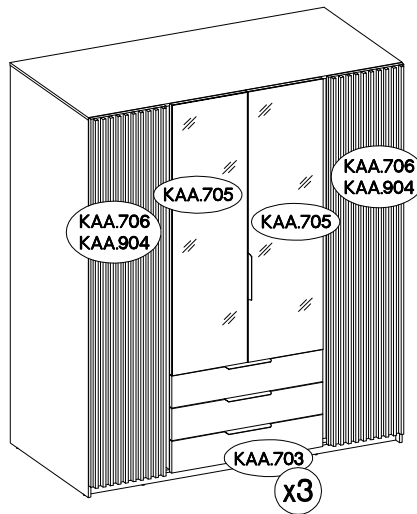

	Ersatzteil Nummer	Dimension
	KAA.706 x2	2309x479x16
	KAA.904 x20	2307x18x18
	KAA.704 x2	1697x479x16
	KAA.703 x3	962x200x16
		



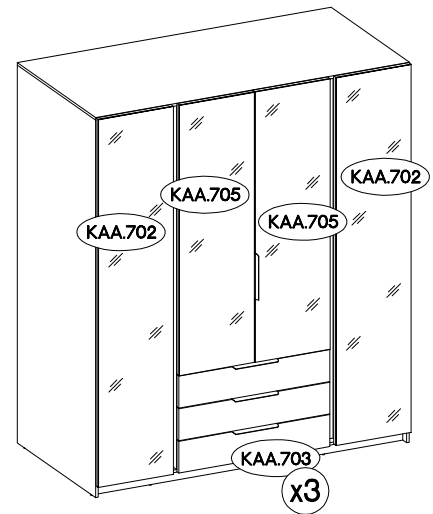

	Ersatzteil Nummer	Dimension
	KAA.706 x2	2309x479x16
	KAA.904 x20	2307x18x18
	KAA.705 x2	1697x479x19
	KAA.703 x3	962x200x16
		

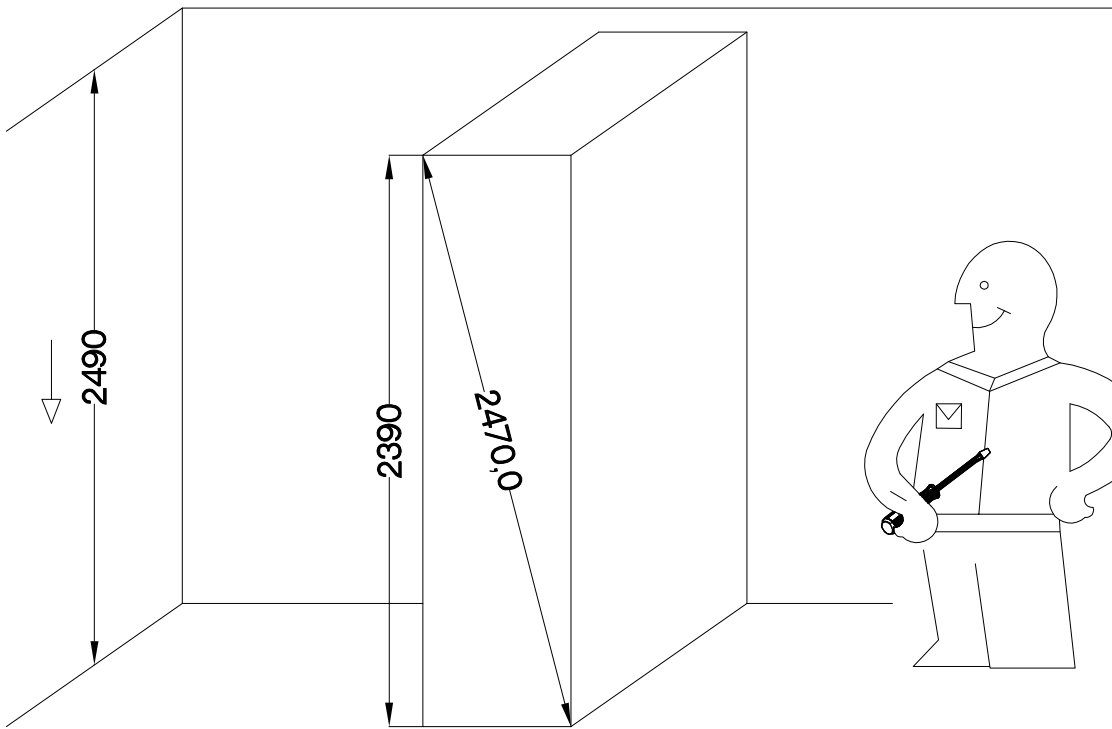
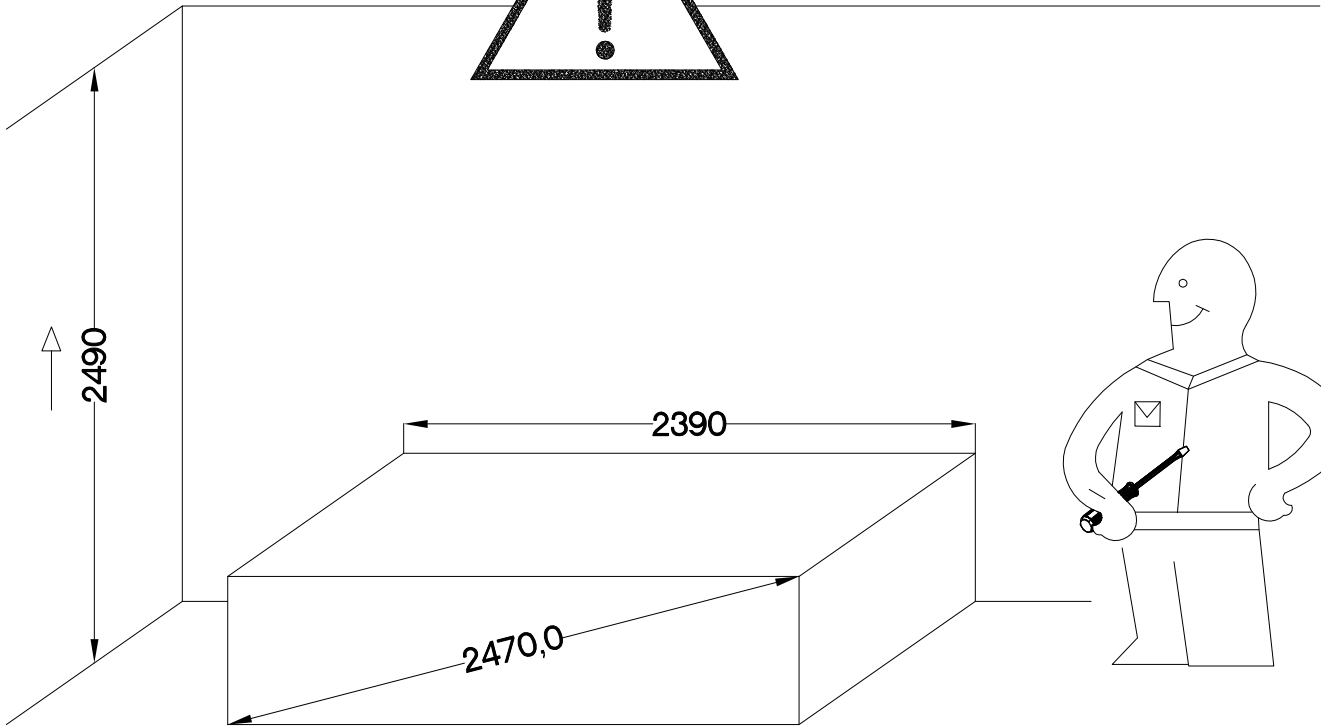
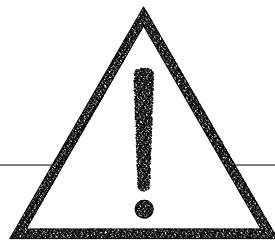

	Ersatzteil Nummer	Dimension
	KAA.702 x2	2309x479x19
	KAA.705 x2	1697x479x19
	KAA.703 x3	962x200x16



1

#12/10mm  C5 6	#8x30mm  A 12
--	---

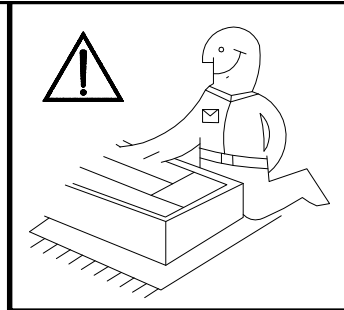

x3

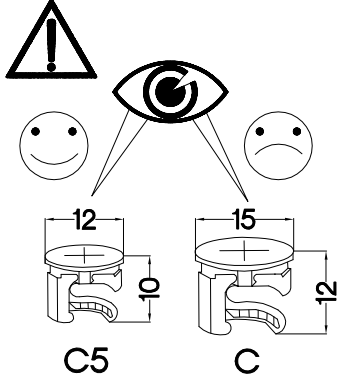
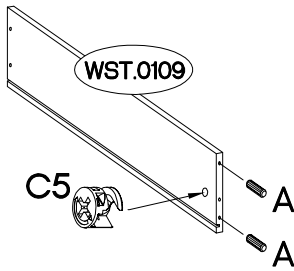
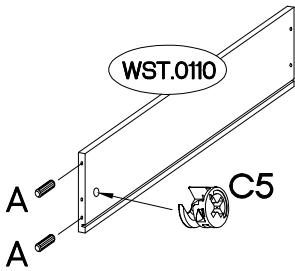

2

#6x42mm  B2 12

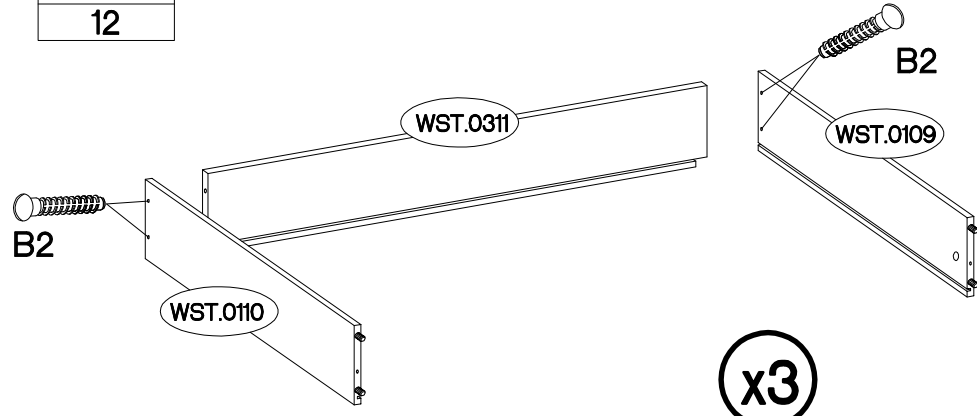

x3

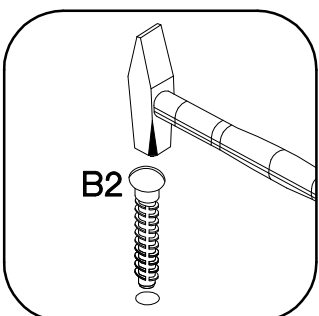

3

L=20mm  D2 6

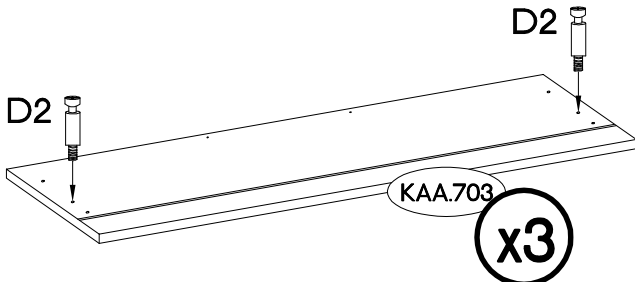
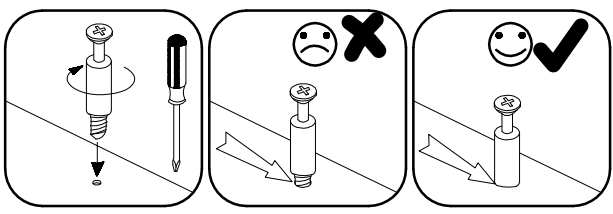

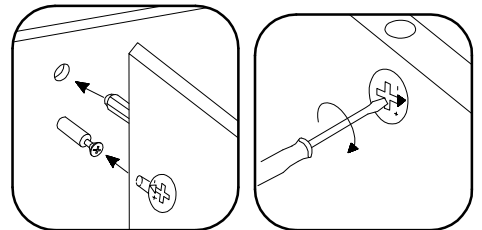
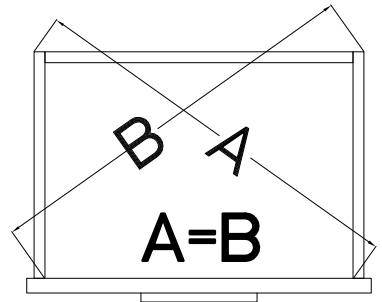
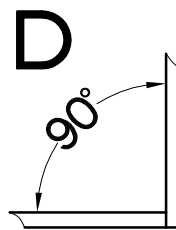
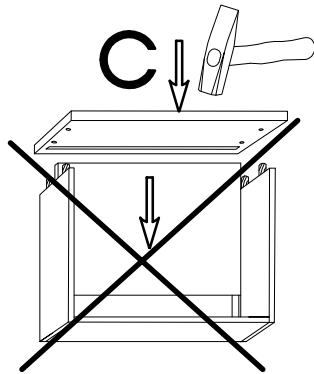
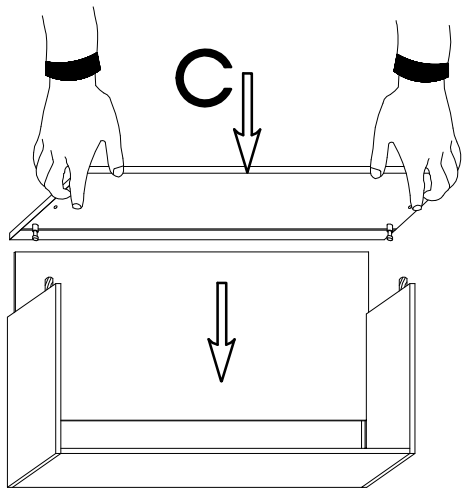
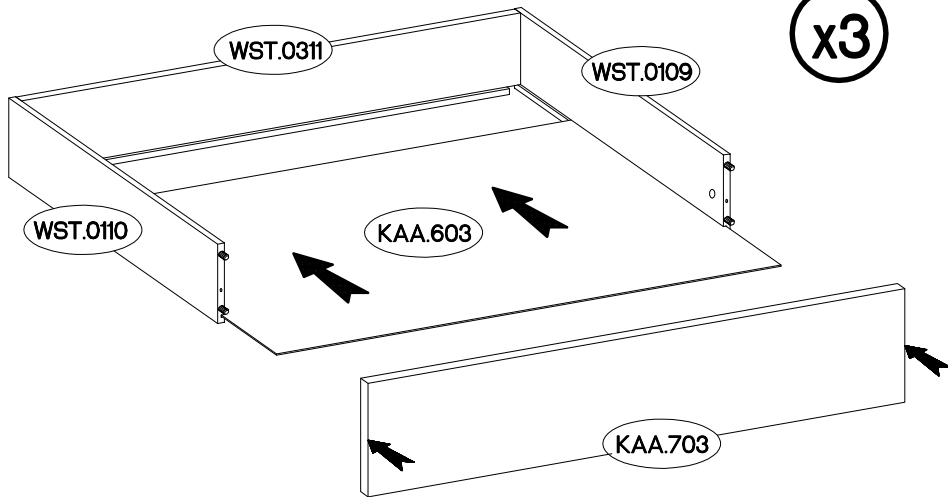
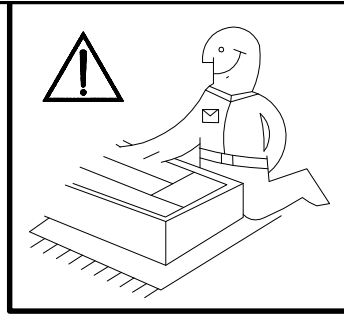

x3

4





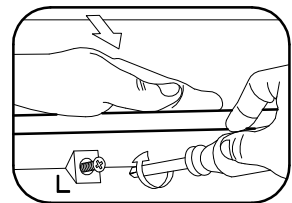
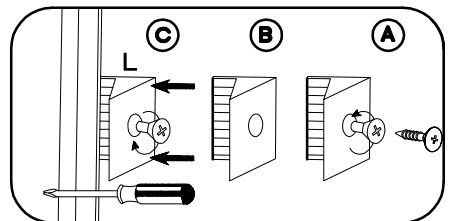
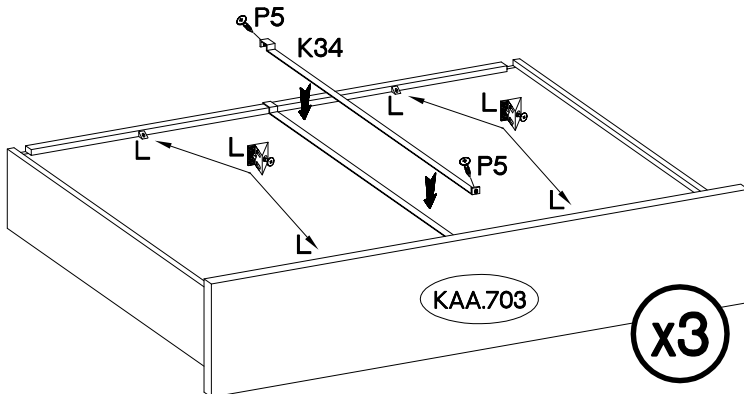

5

	L=450 mm		$\varnothing 3.5 \times 13 \text{ mm}$
L		K34	P5
12	3		6



6



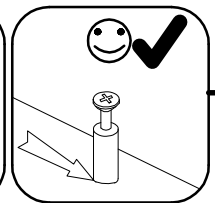
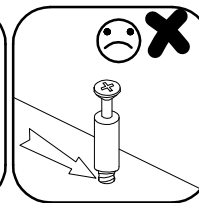
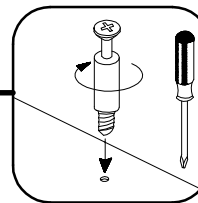
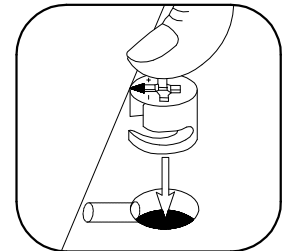
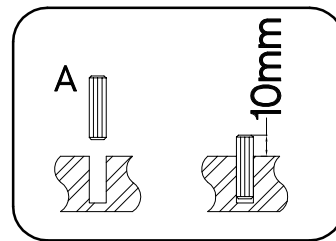
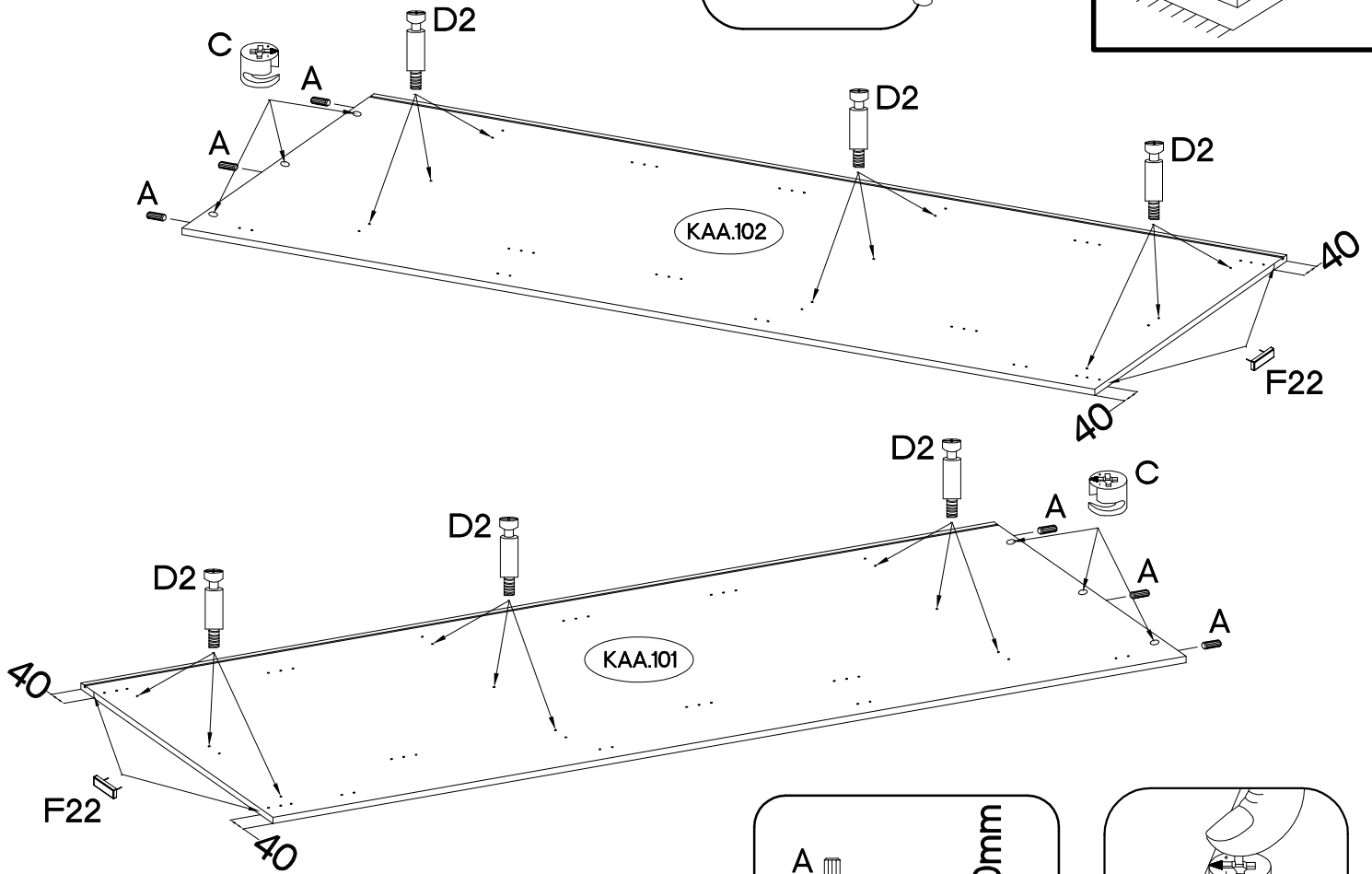
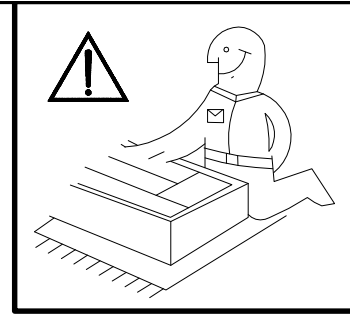
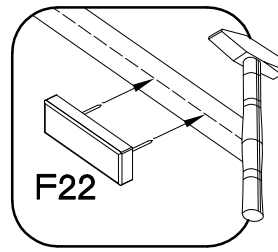

±8x30mm  A 6	±15/12mm  C 6	L=20mm  D2 18	6.5x48x16  F22 4
---	--	--	---



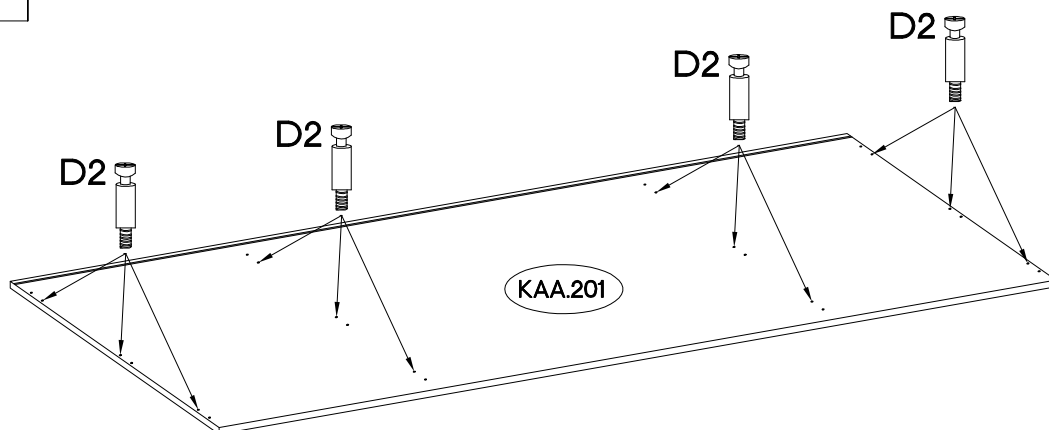



7

L=20mm  D2 12

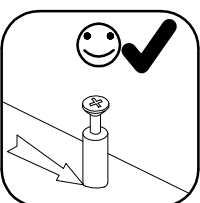
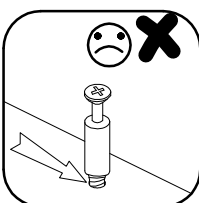
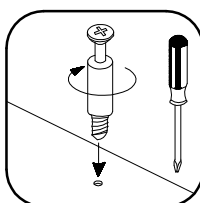
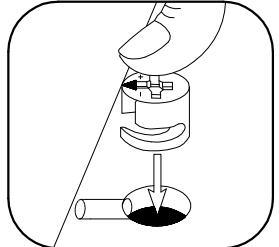
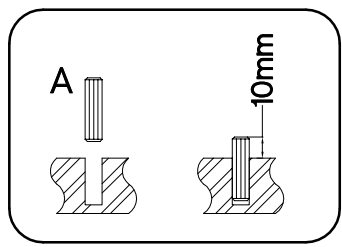
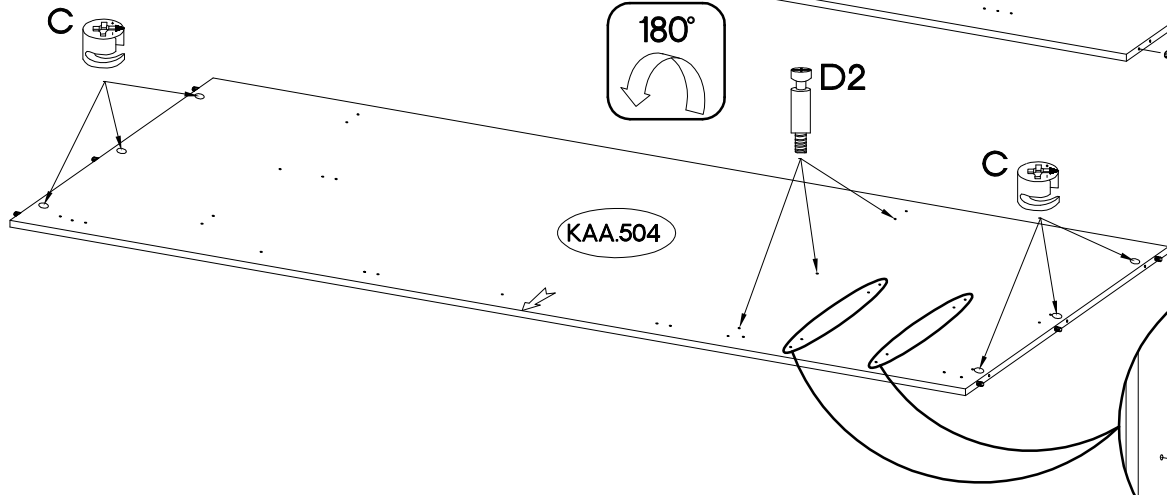
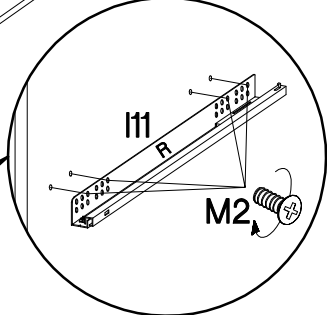
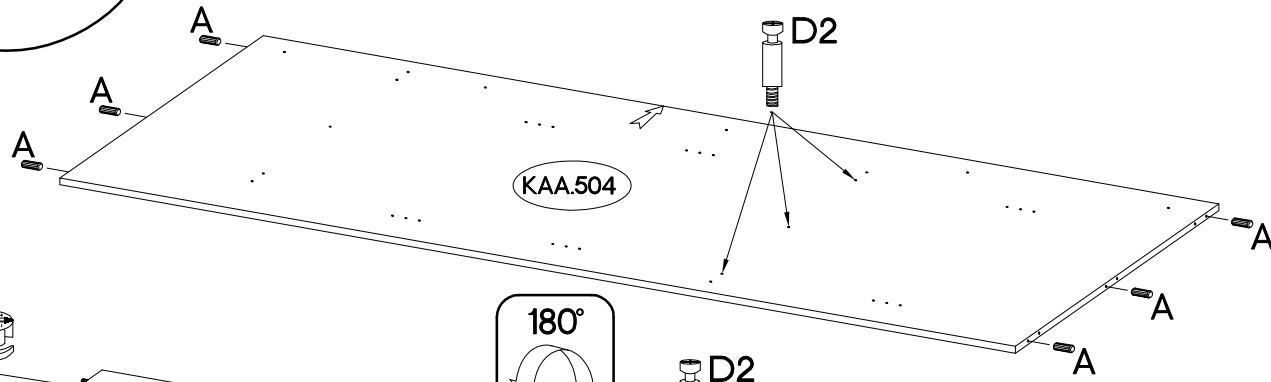
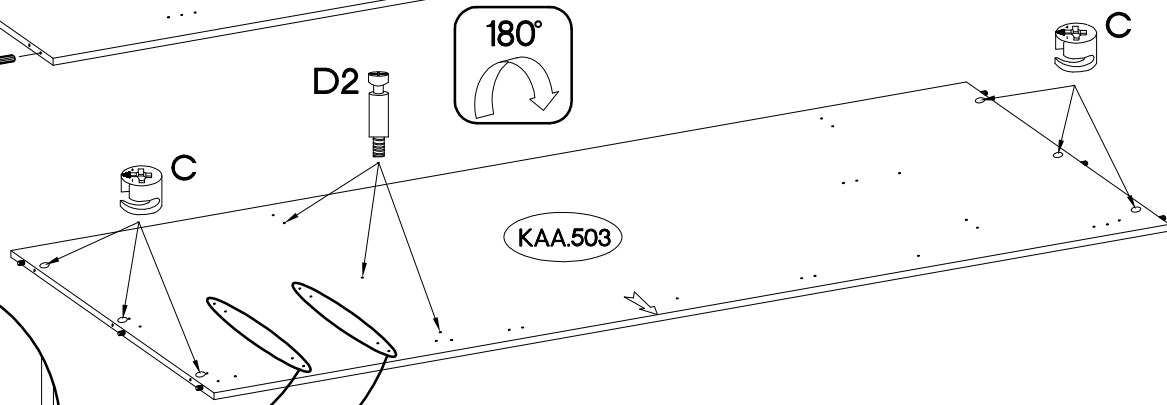
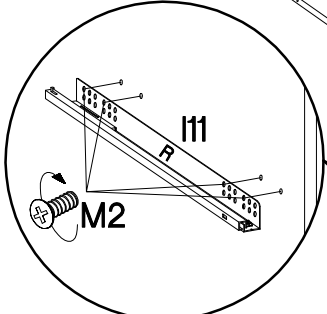
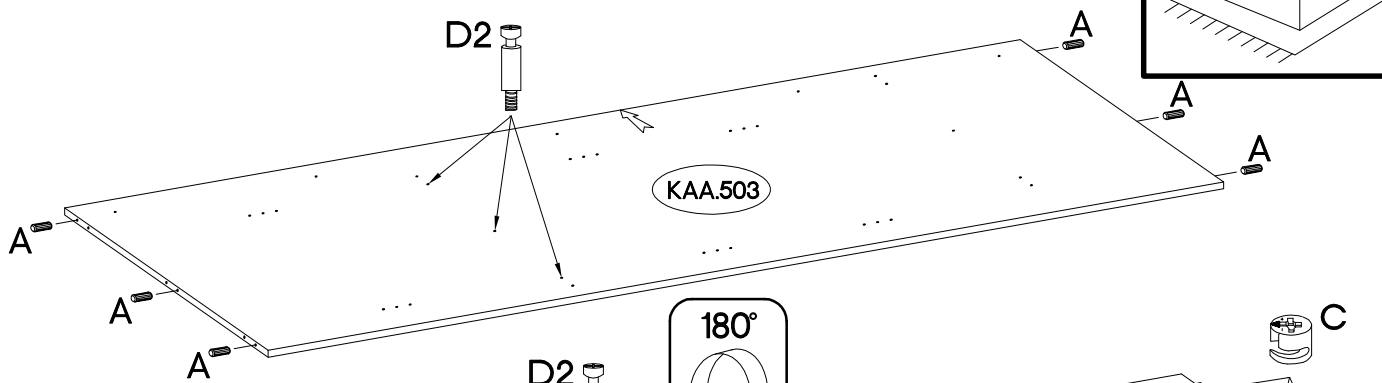
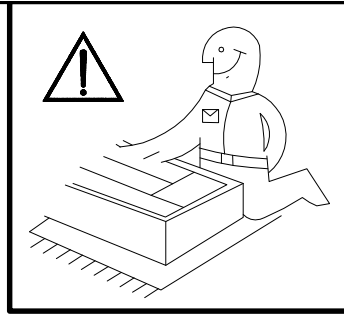





$\pm 8 \times 30 \text{mm}$  A 12	$\pm 15/12 \text{mm}$  C 12	L=20mm  D2 12	$\text{L} \quad \text{R}$  I1 2	[CD] $\pm 6.3 \times 13 \text{mm}$  M2 16
--	--	--	--	--

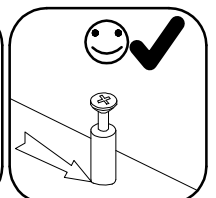
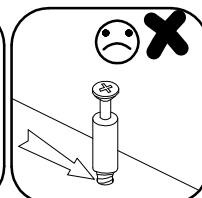
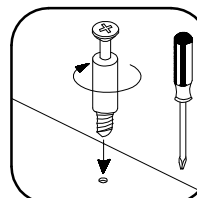
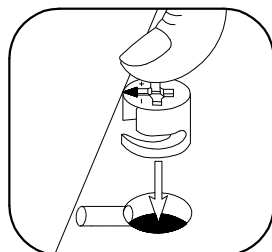
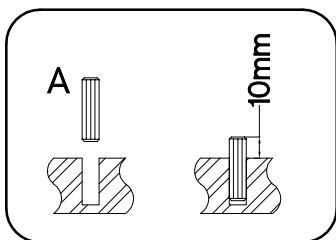
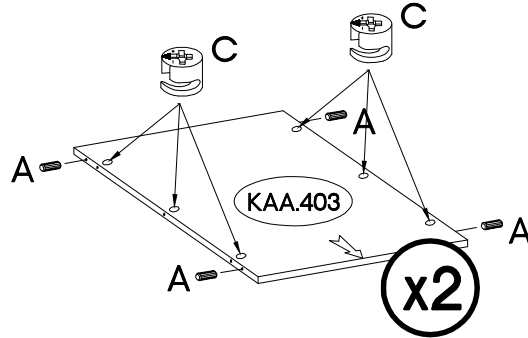
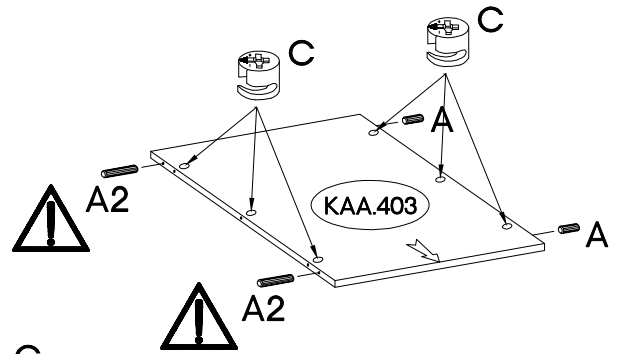
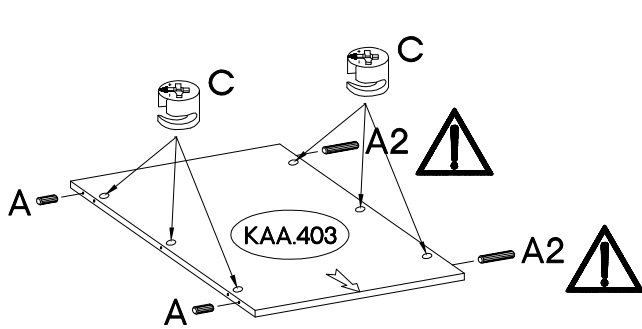
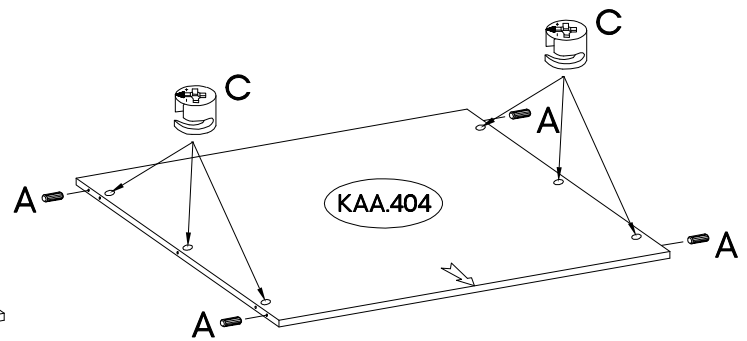
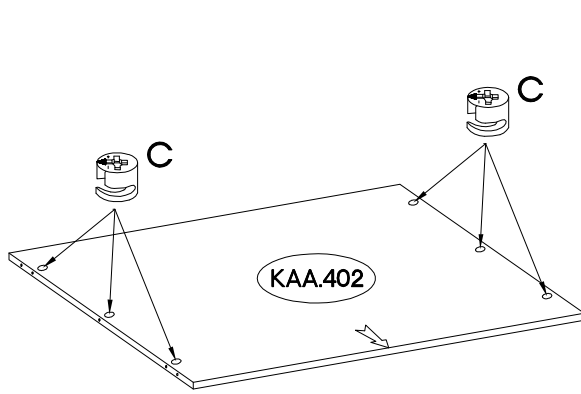
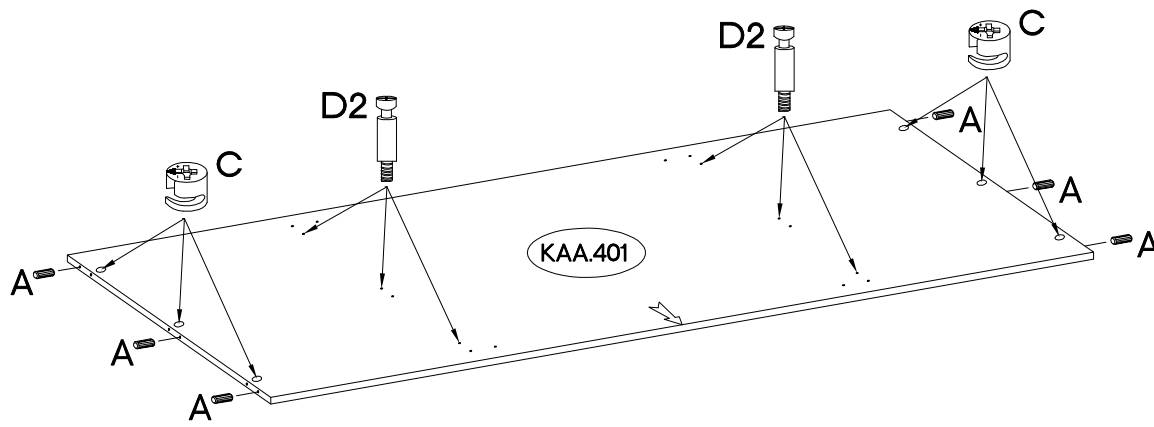
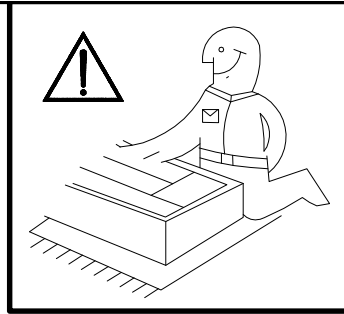

+8x30mm  A 22	+8x60mm  A2 4	+15/12mm  C 42	L=20mm  D2 6
--	--	---	---



 A 8	 F22 4	 B1 10	 O 1
--	--	--	--

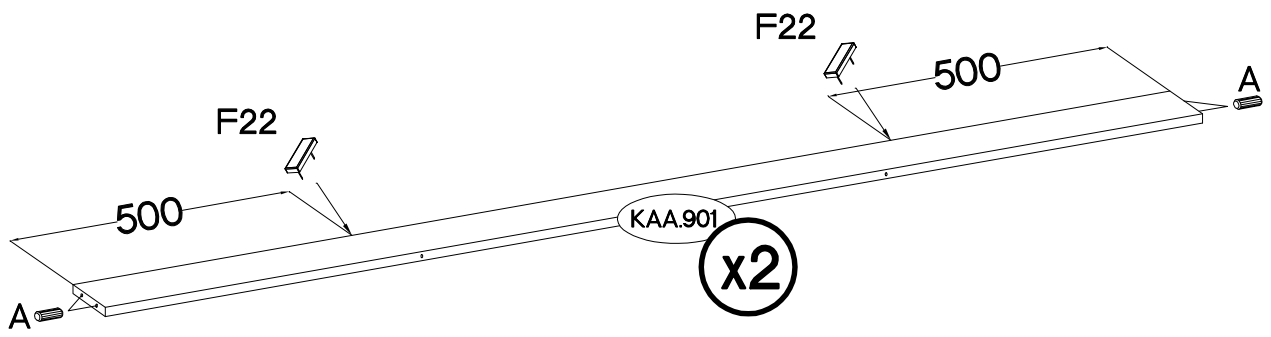
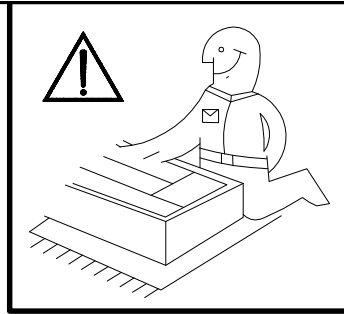

x2

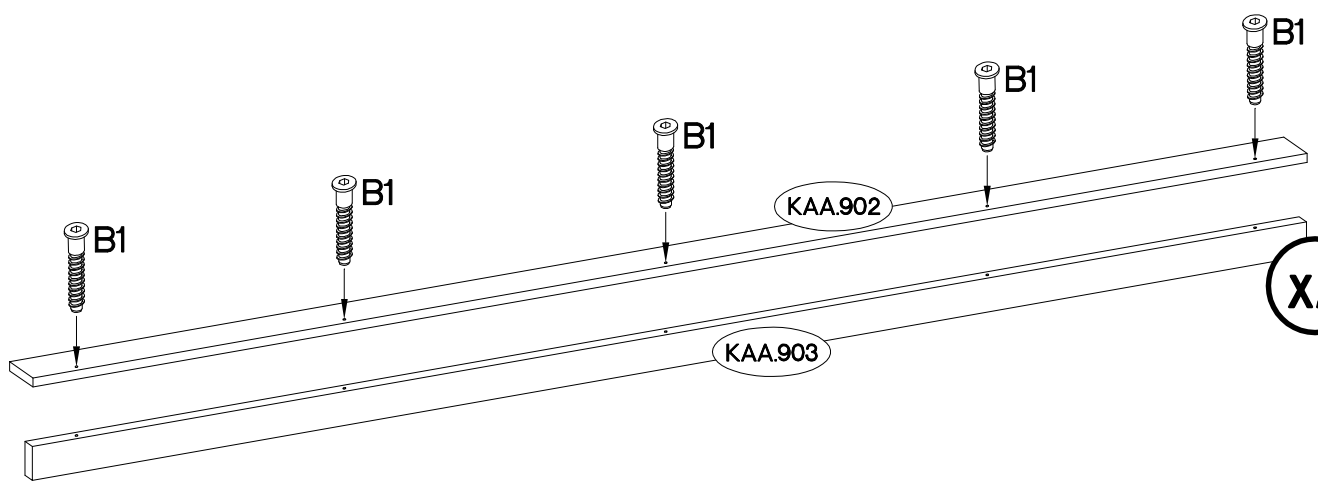

x2

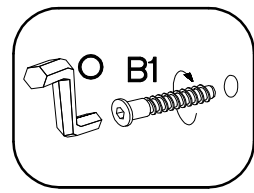
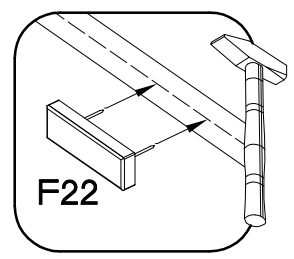
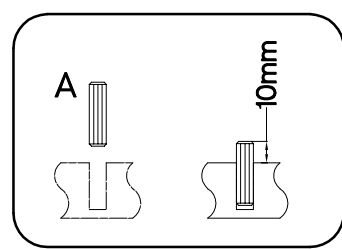
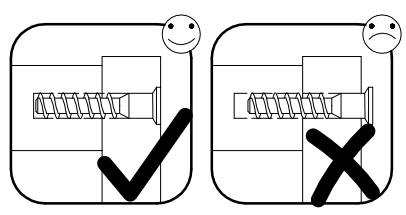

11

L=56mm

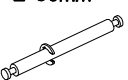

D4

3

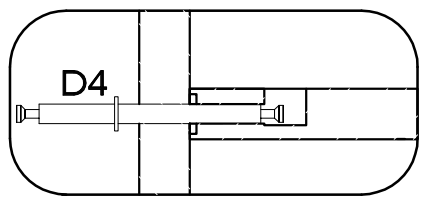
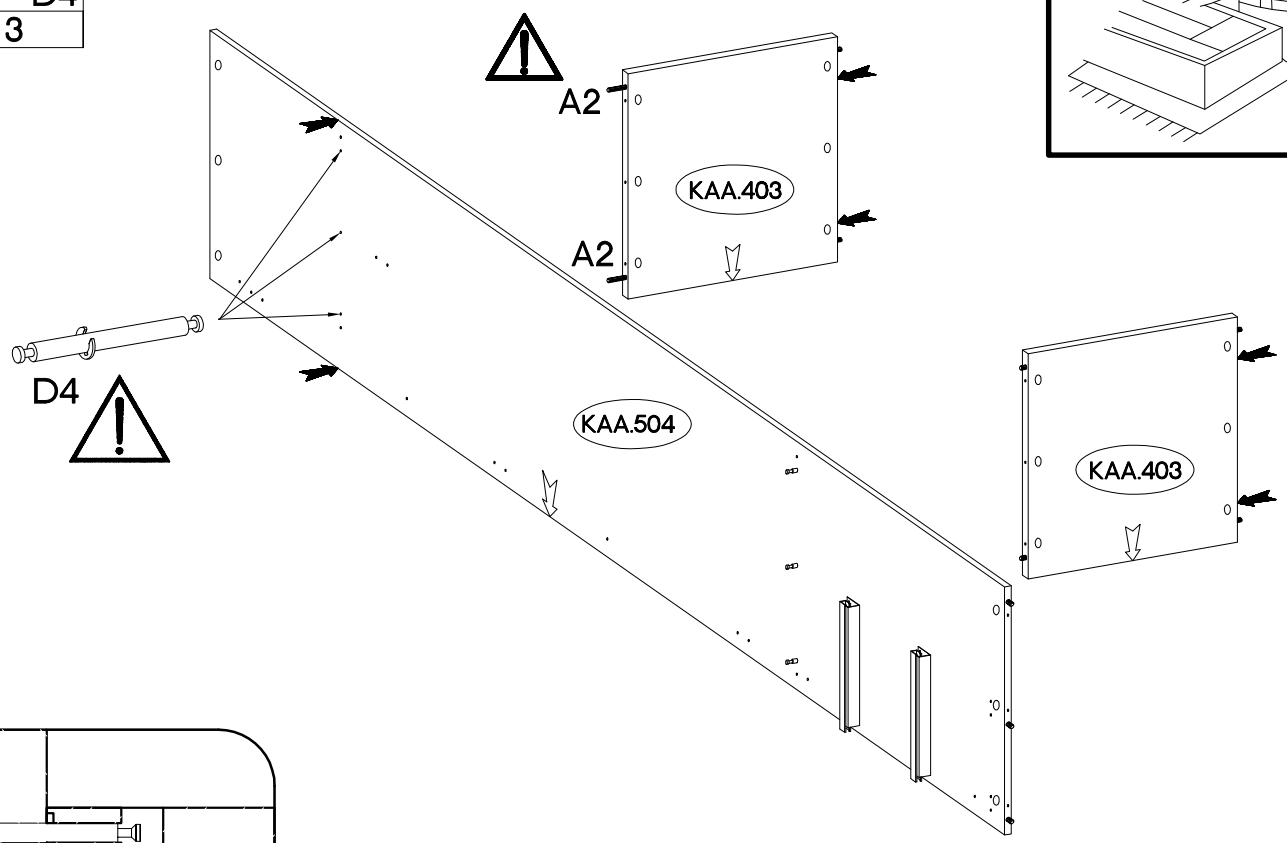
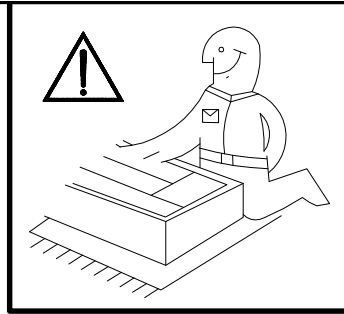

12

6,4 x 35mm



B1

5

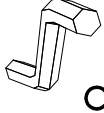

O

1

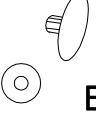

E1

10

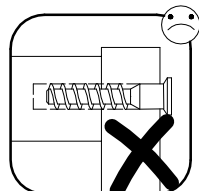
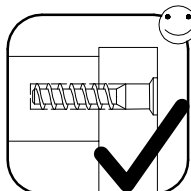
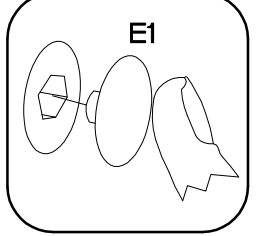
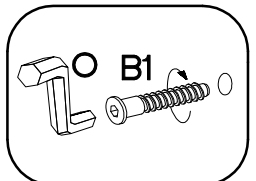
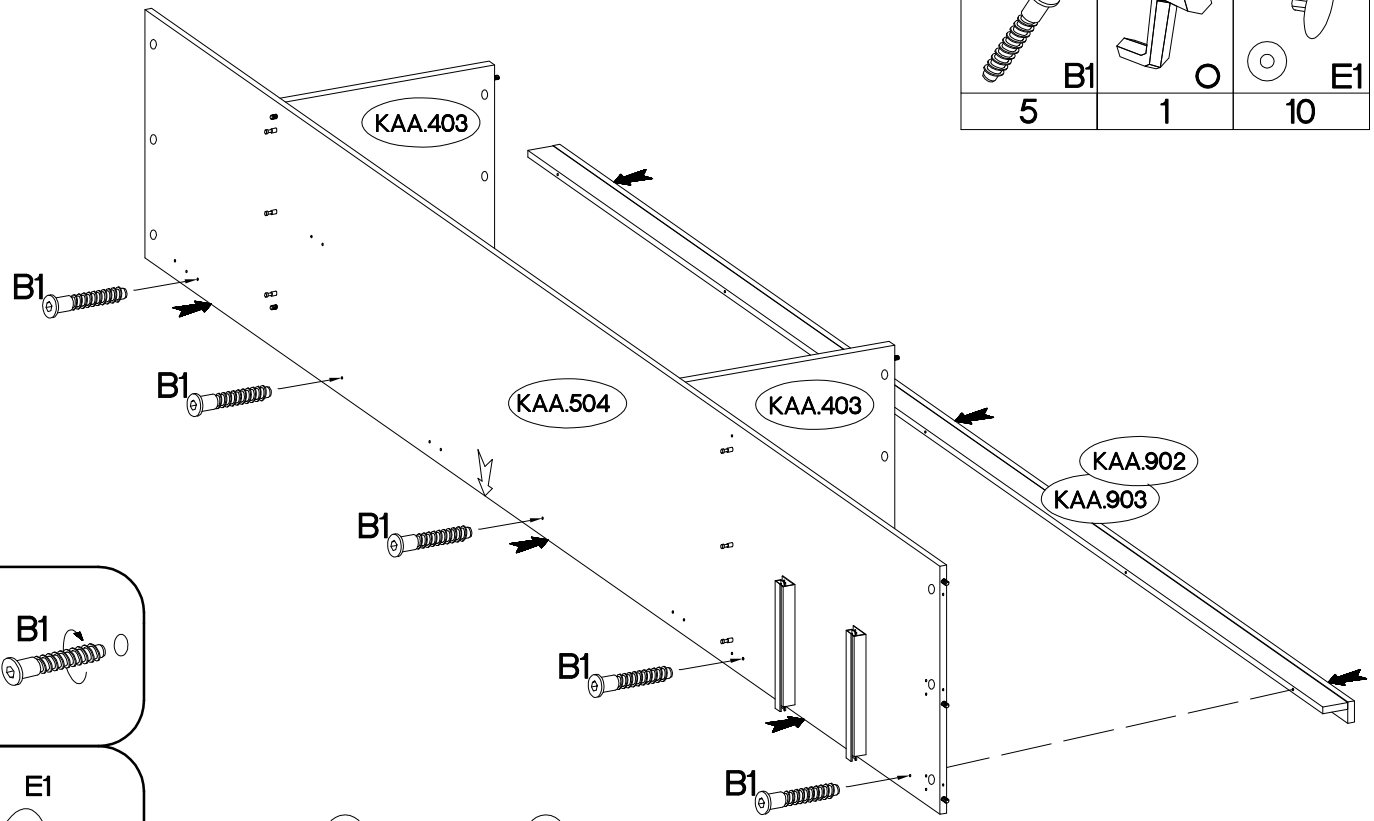

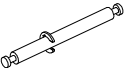

13

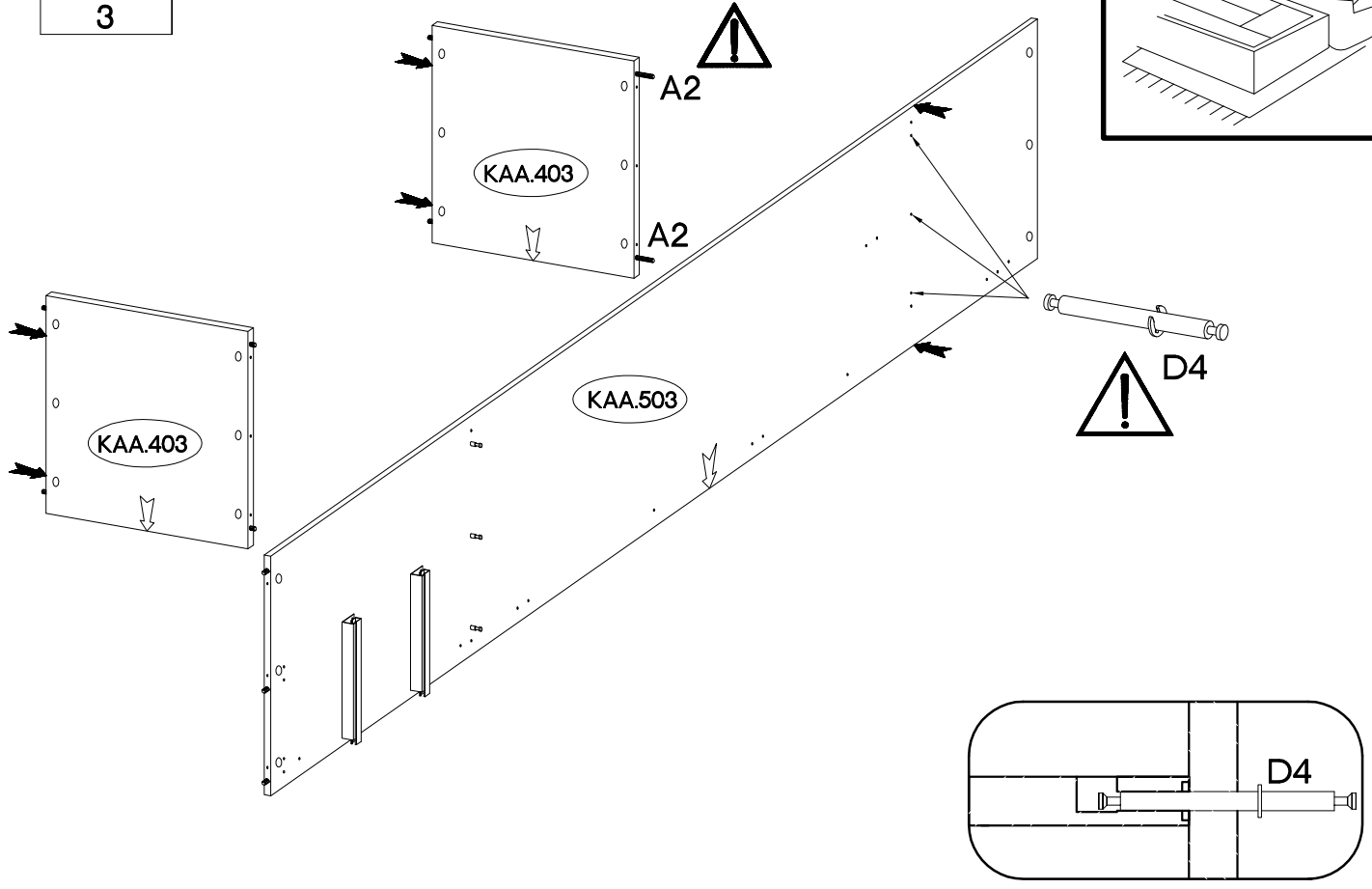
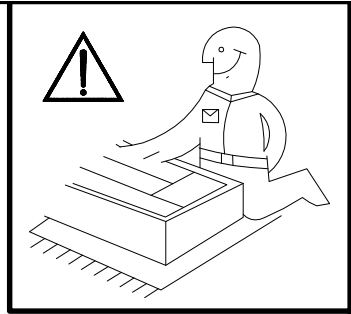
L=56mm

 D4
 3

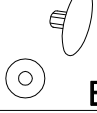

14

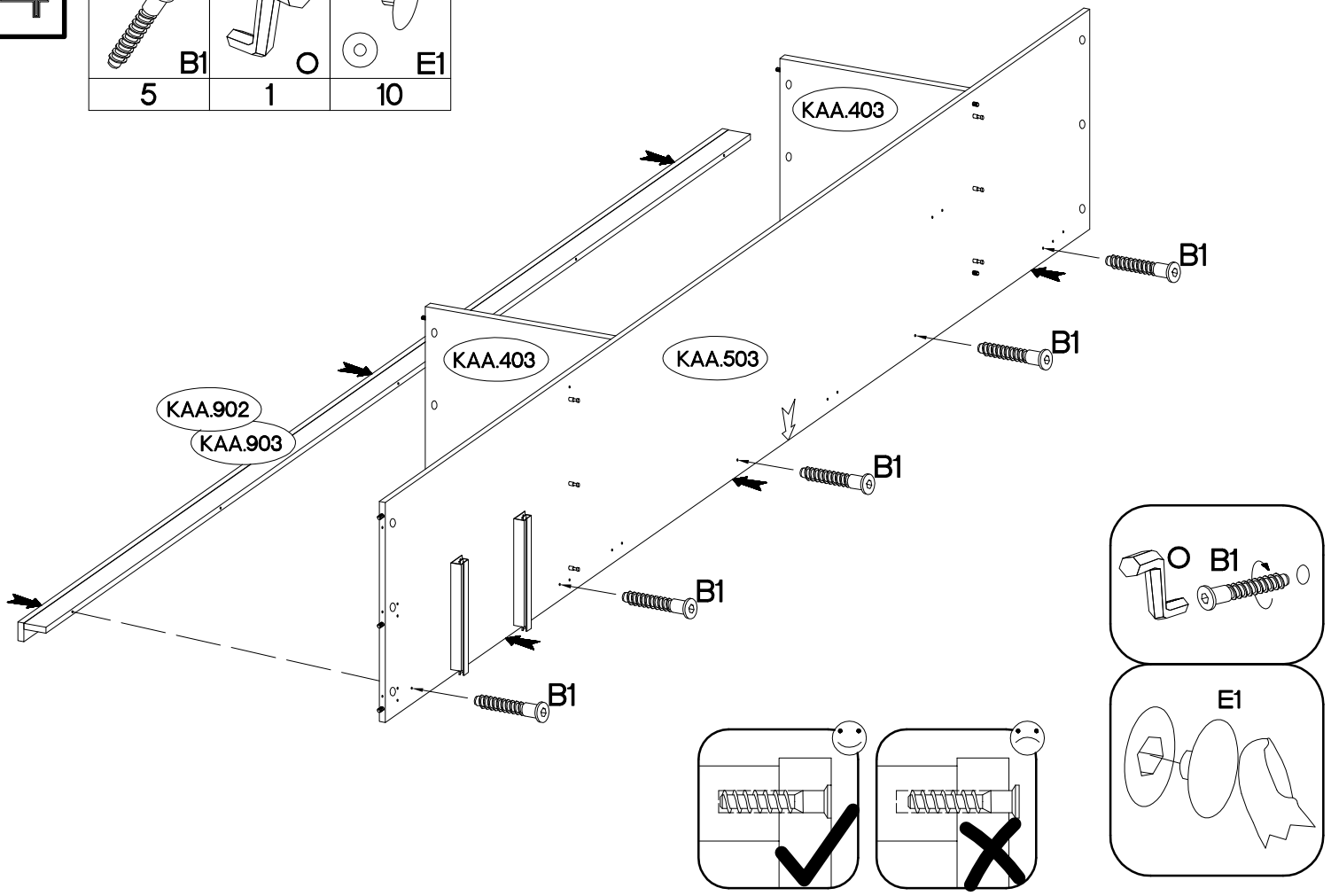
6,4 x 35mm
 B1
 O
 E1
 5 1 10

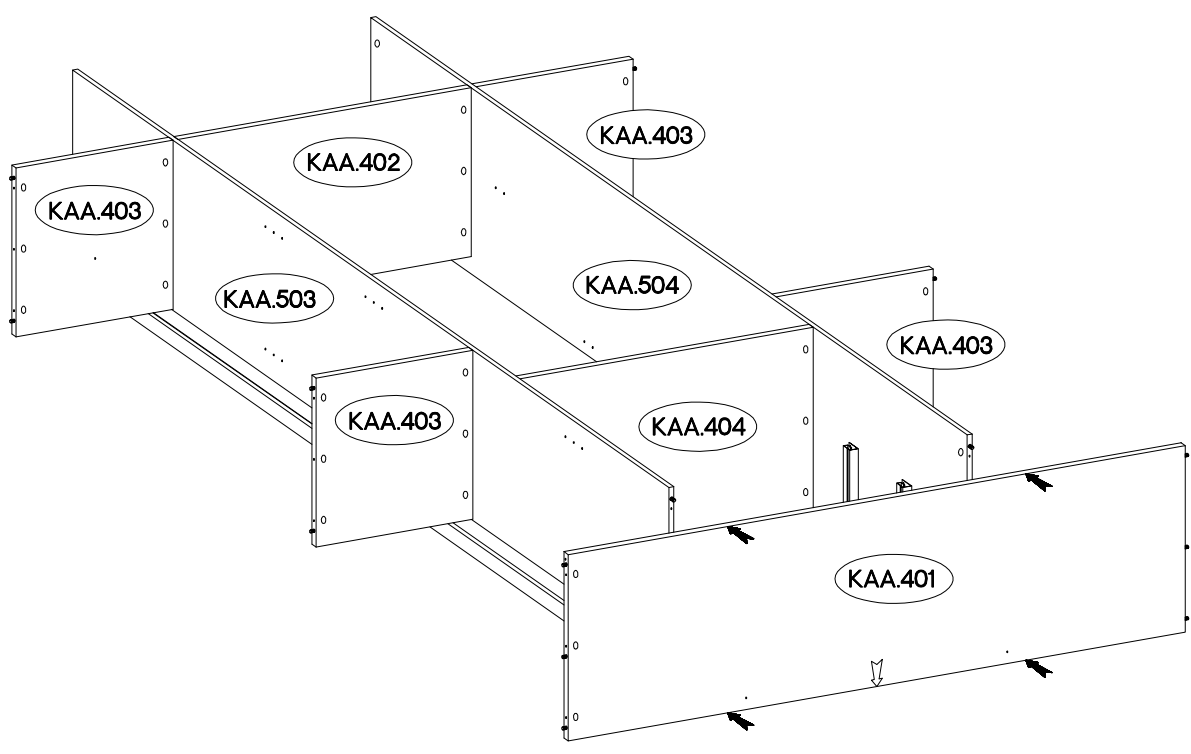
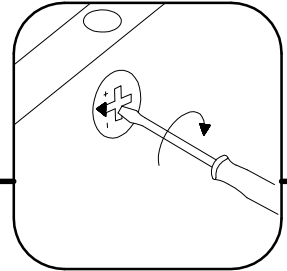
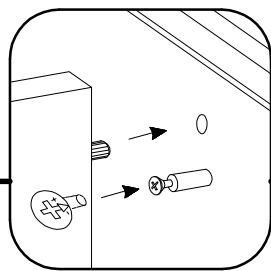
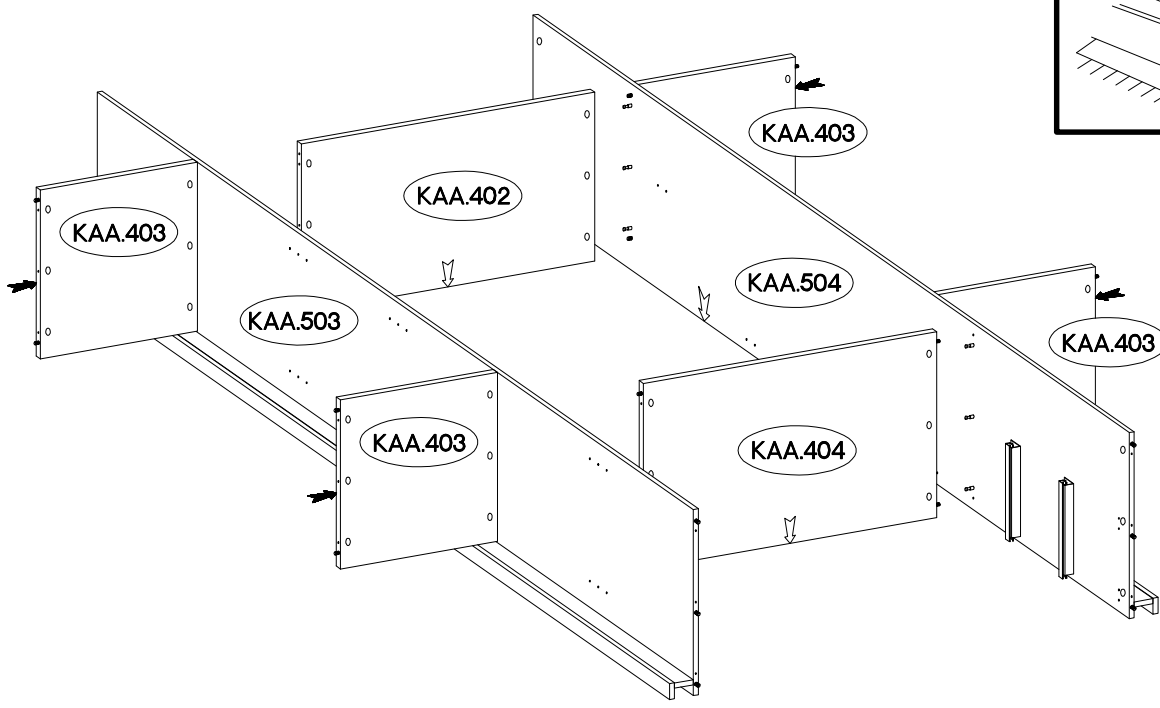
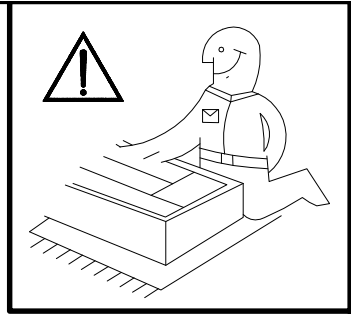



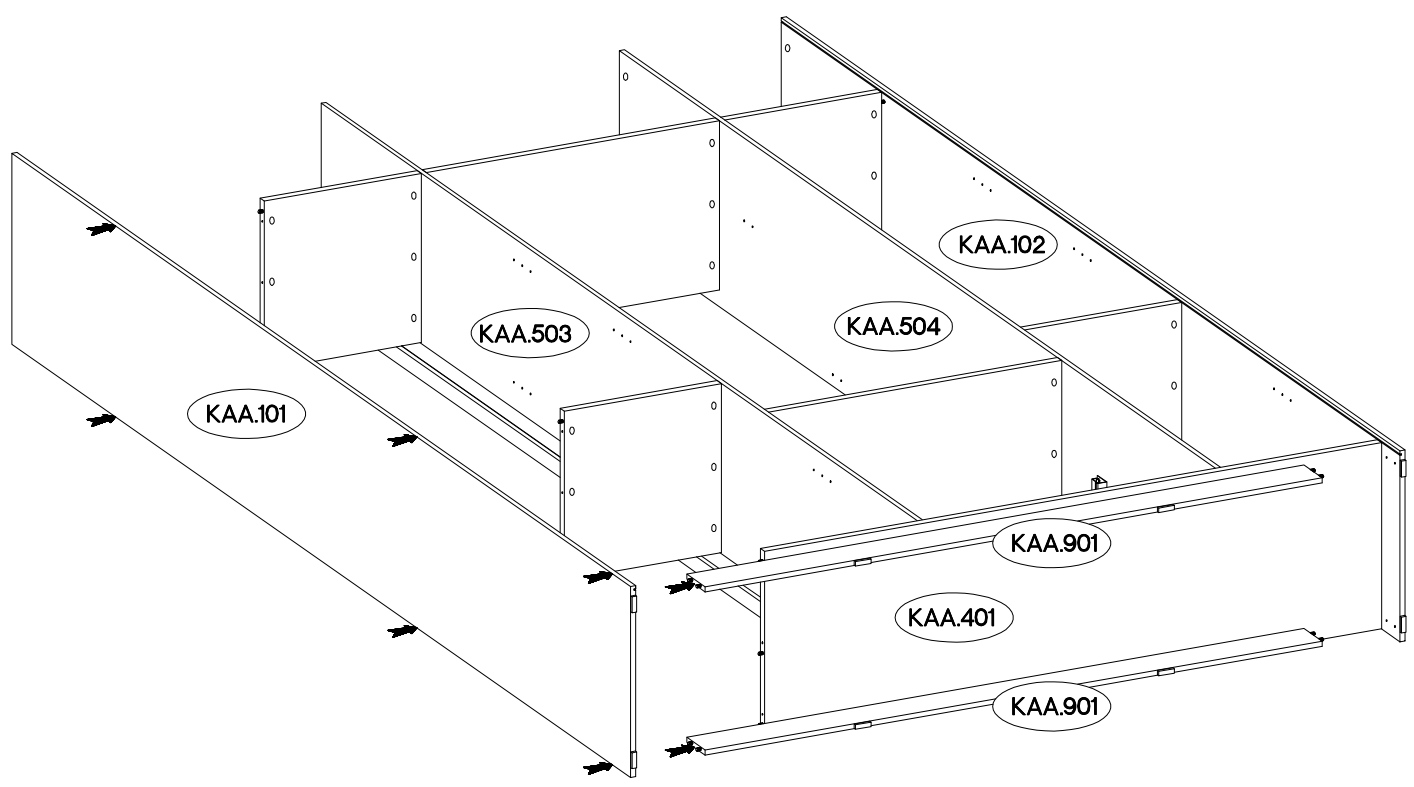
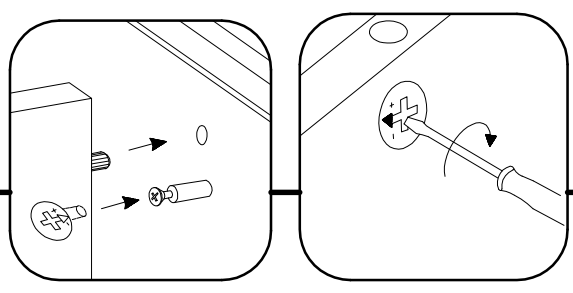
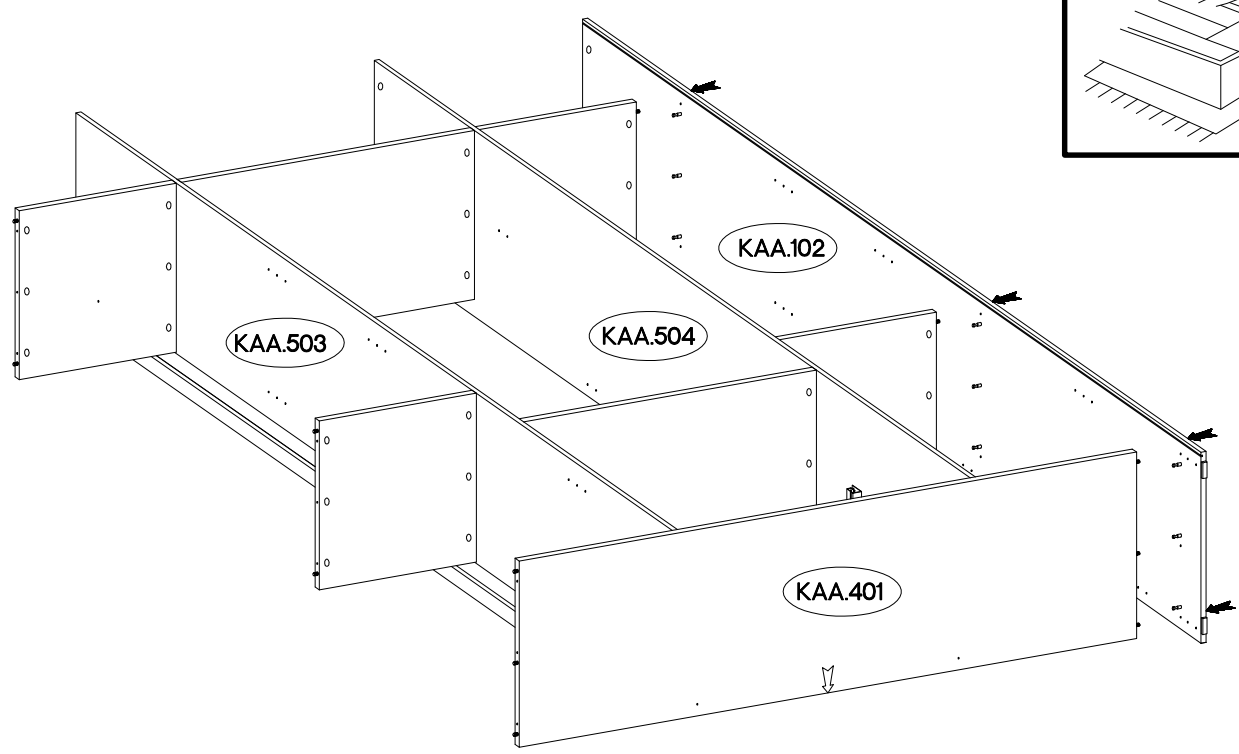
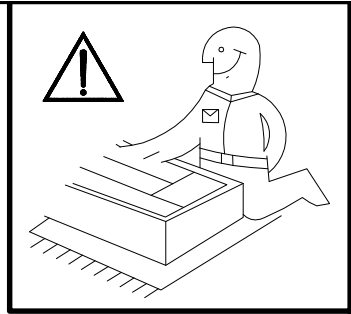

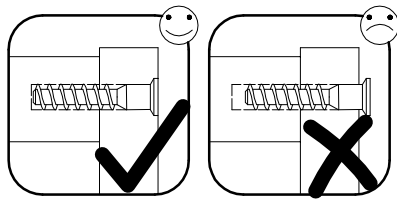
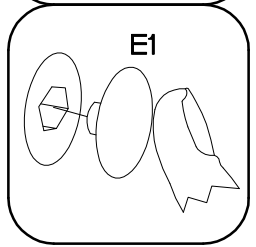
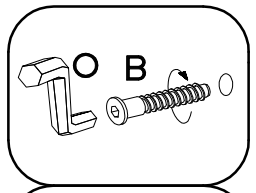
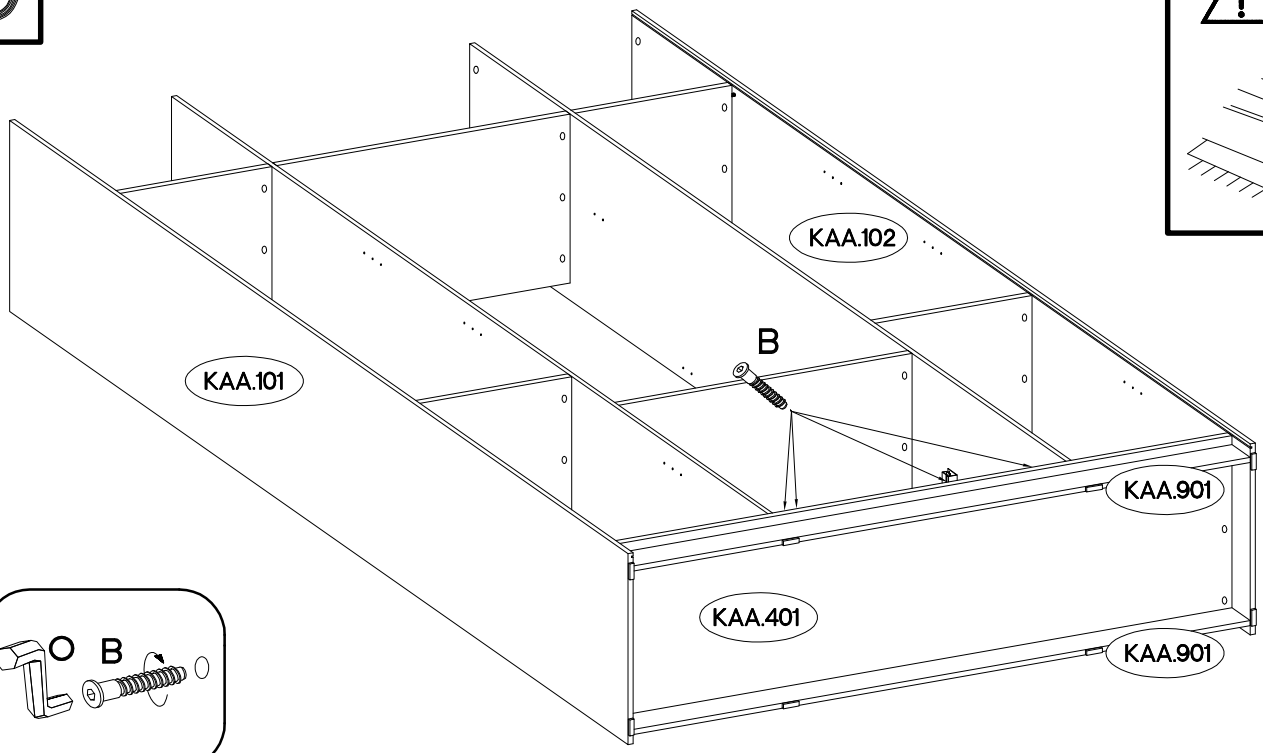
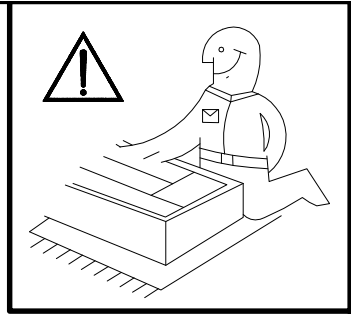



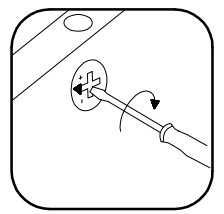
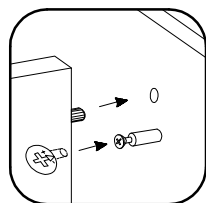
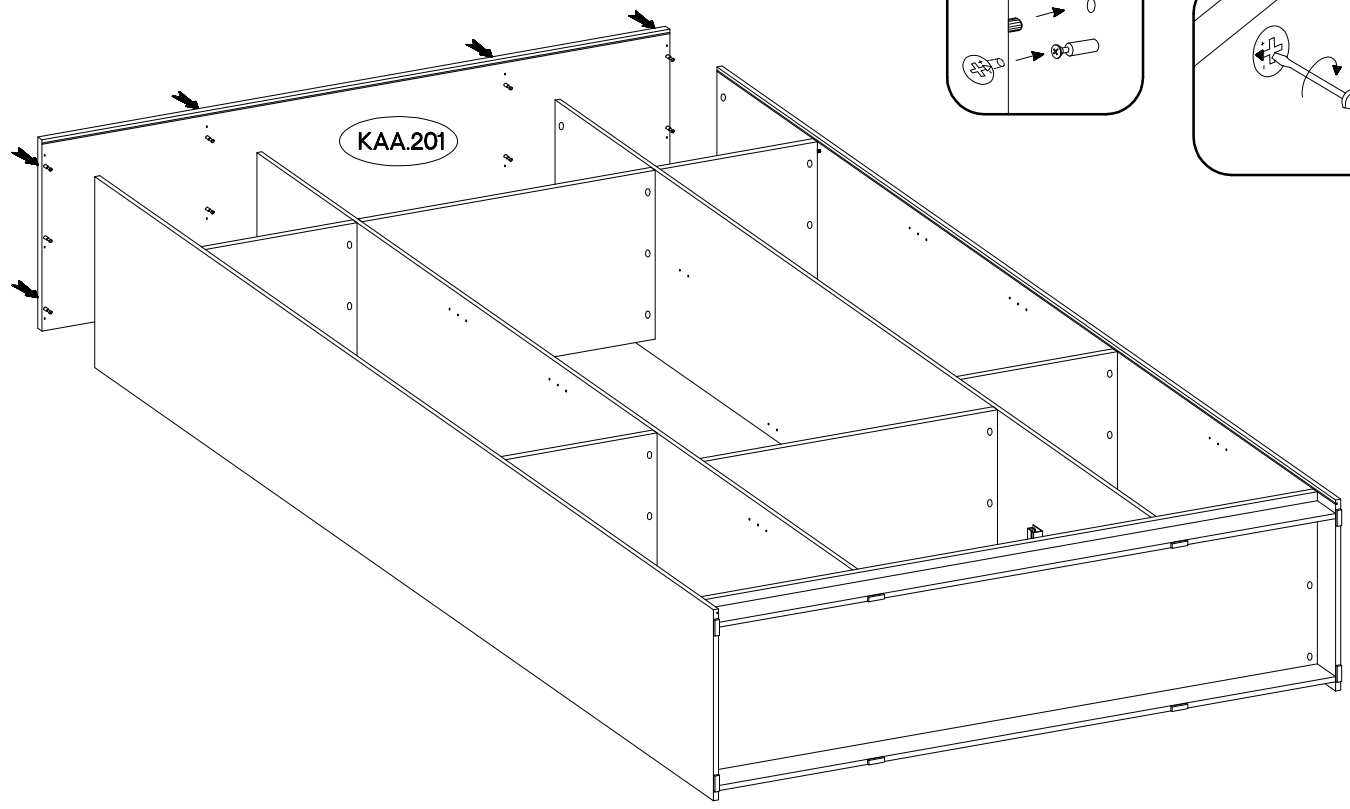

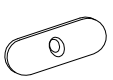

6,4 x 50mm			
	O	B	E1
	1	4	4

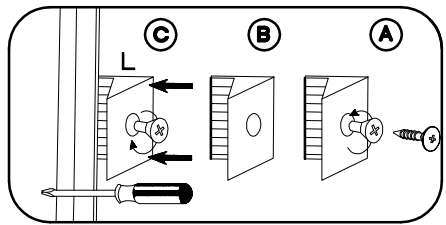
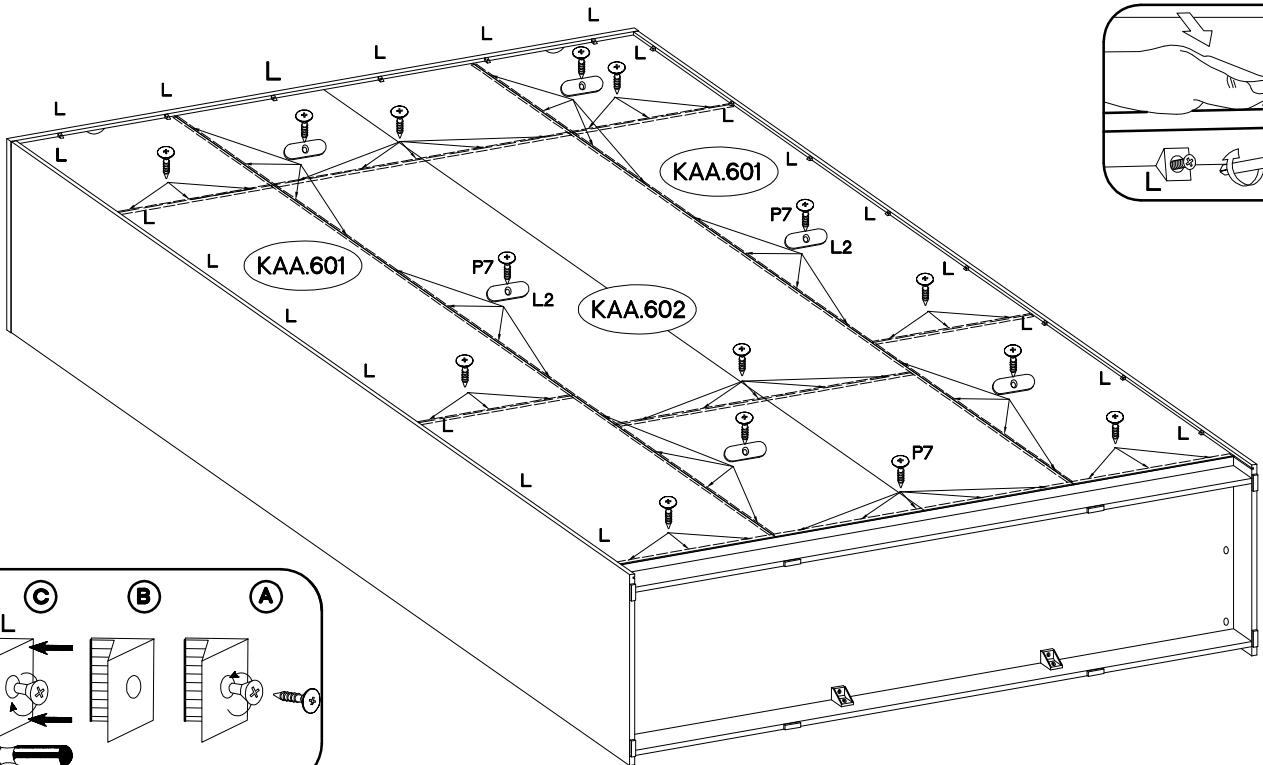
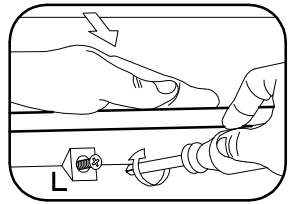
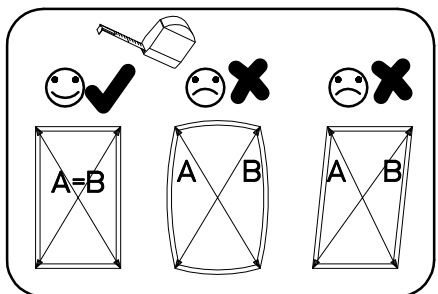
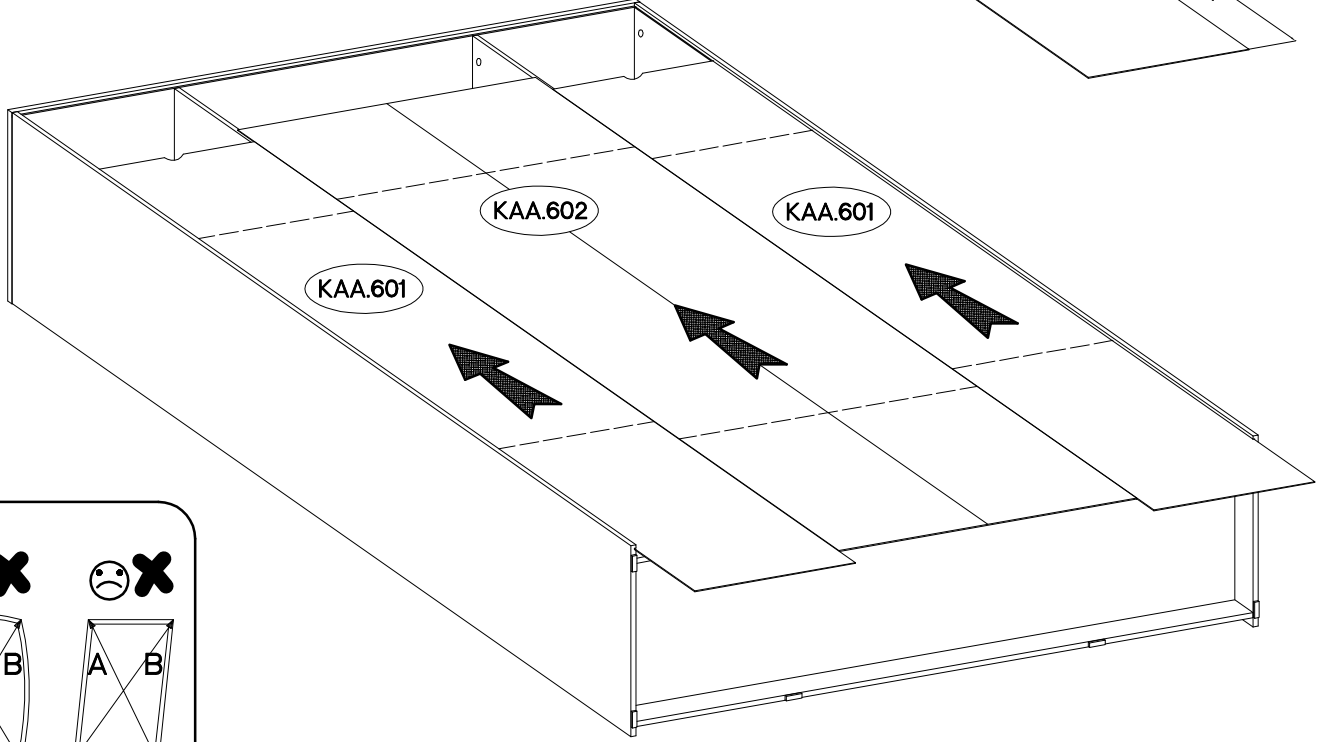
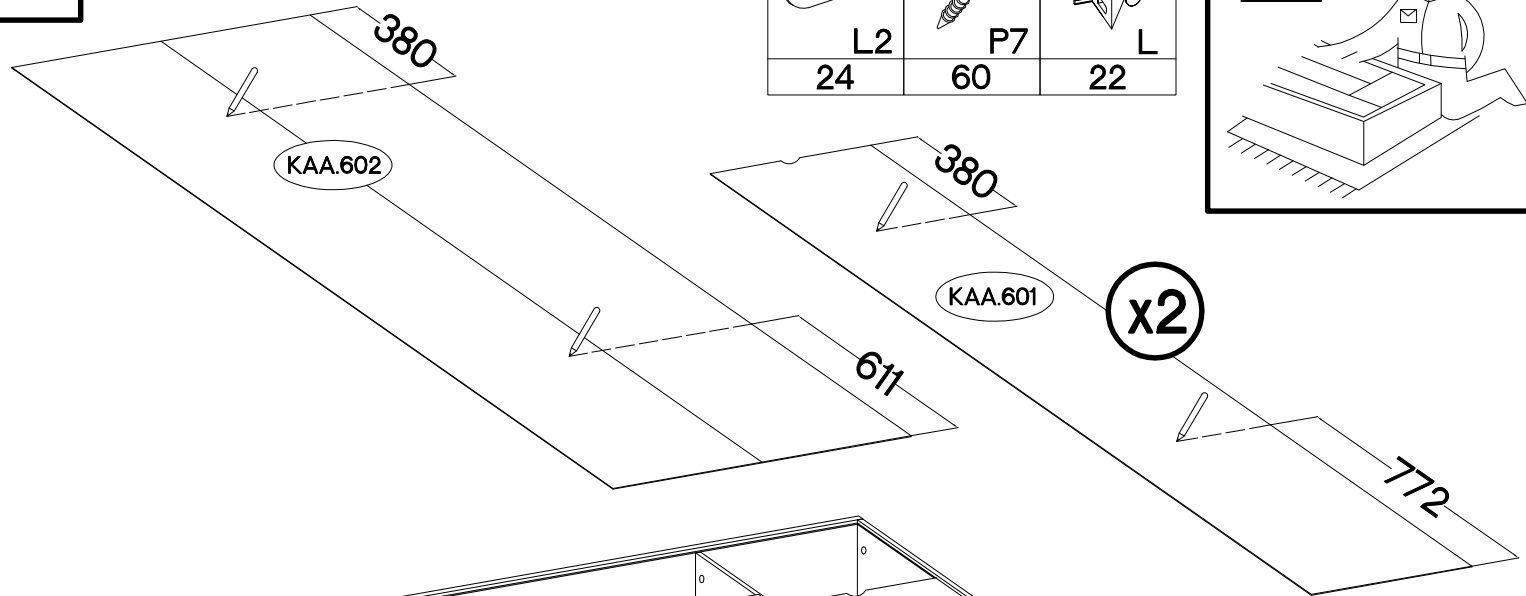
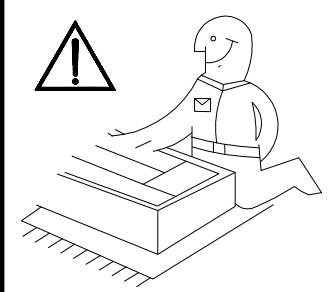

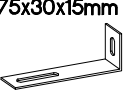



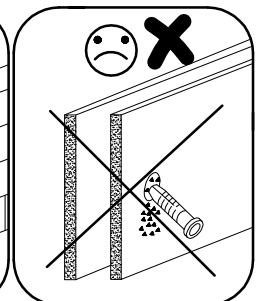
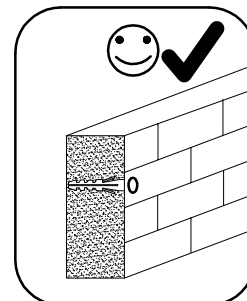
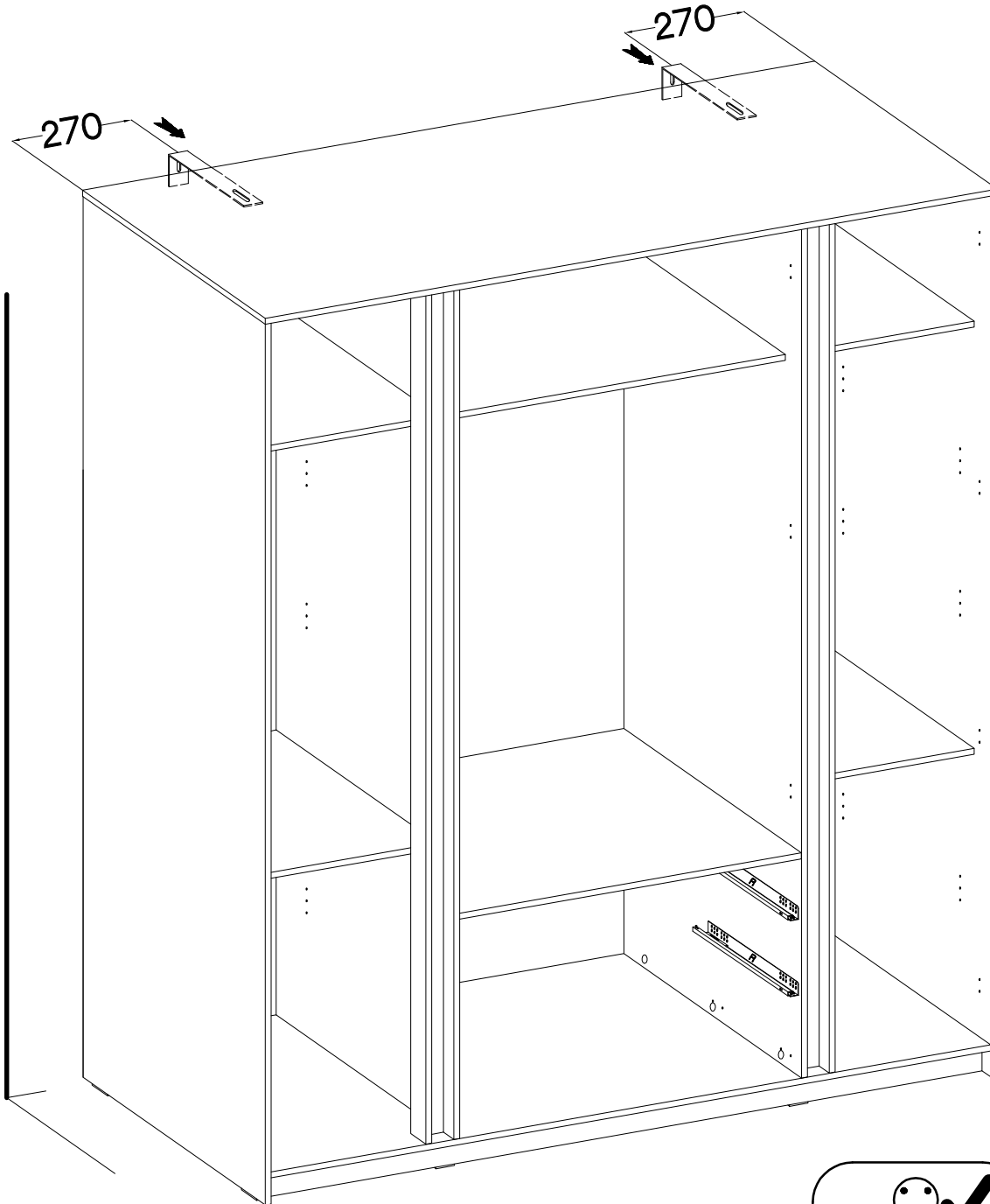
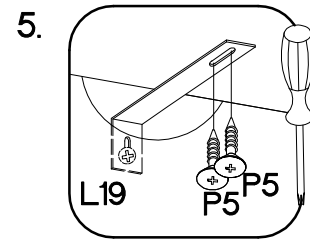
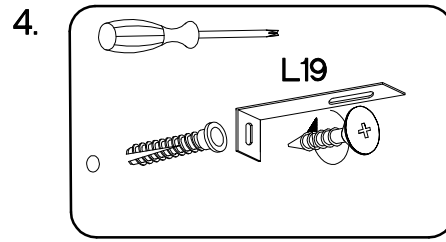
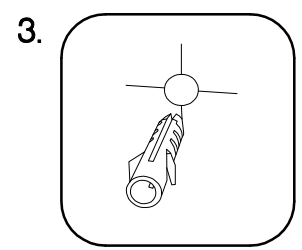
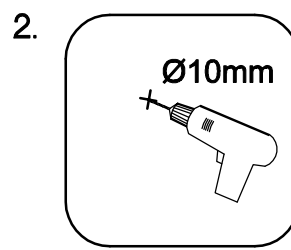
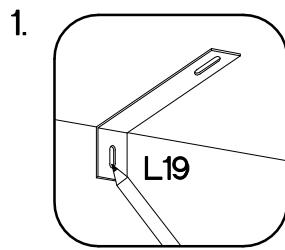

	↑3.0x20mm P7	
L2	P7	L
24	60	22



75x30x15mm  L19	±3.5x13mm  P5	±5.0x60mm  P12	±10x50mm  O7
2	4	2	2

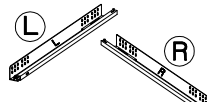

L=926mm  J2	 J17	+3.5x13mm  P5	+5/16mm  J3	 E	 L=450mm I11	[CD] +6.3x13mm  M2
1	2	2	24	42	1	8

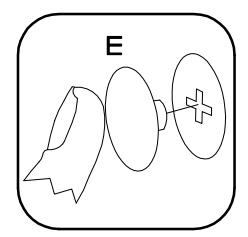
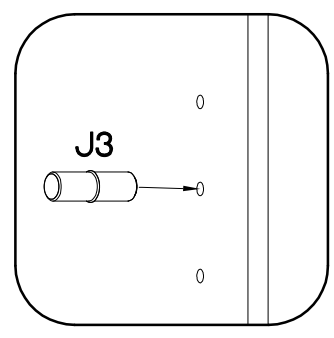
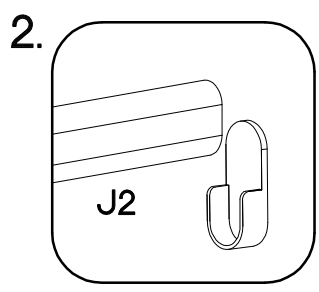
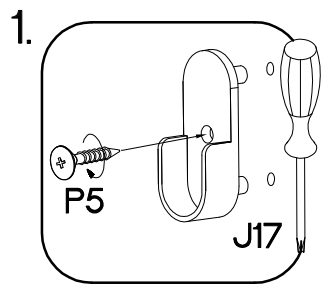
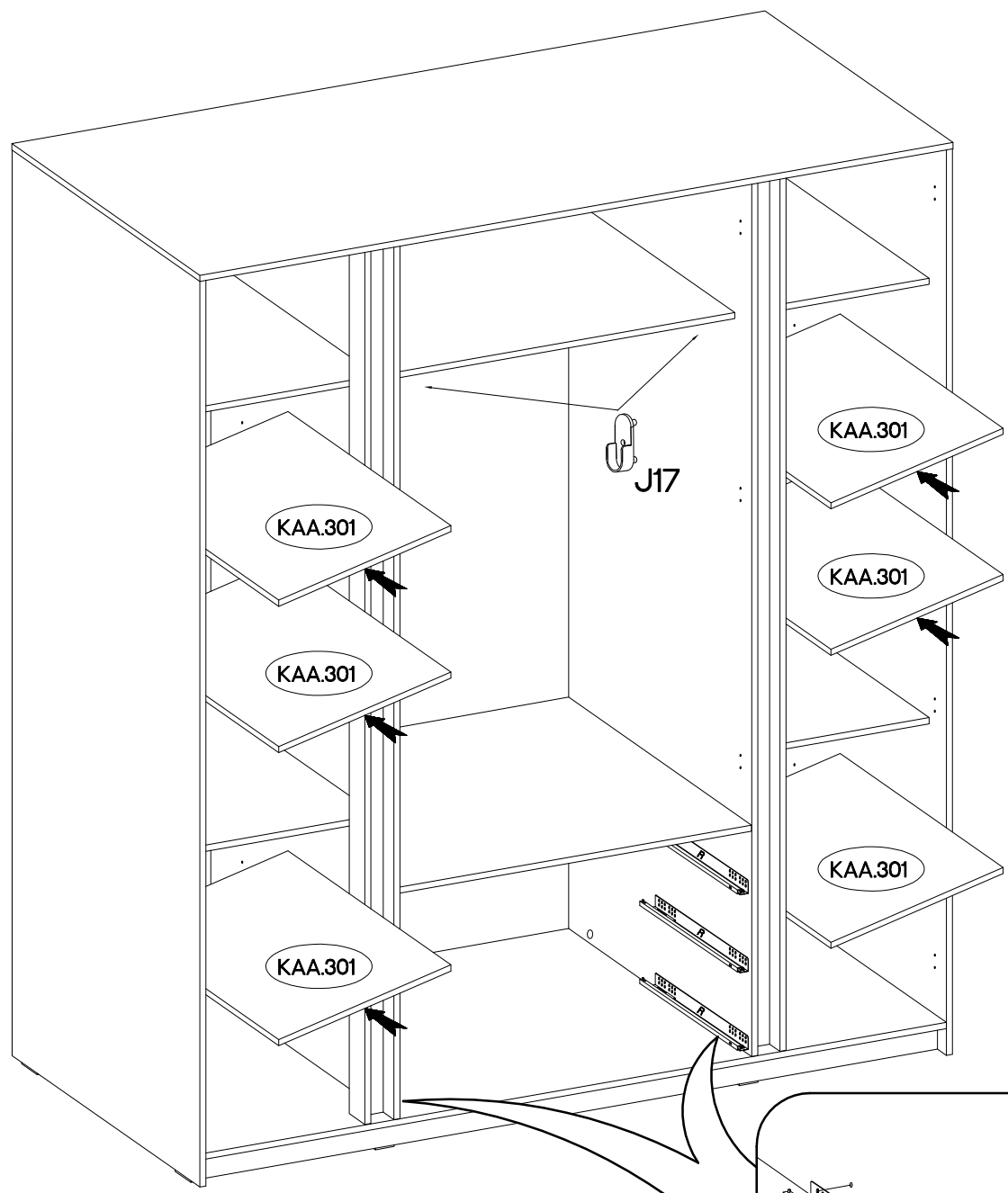

VARIANT - LED

15x15-L=2275mm
J58
1

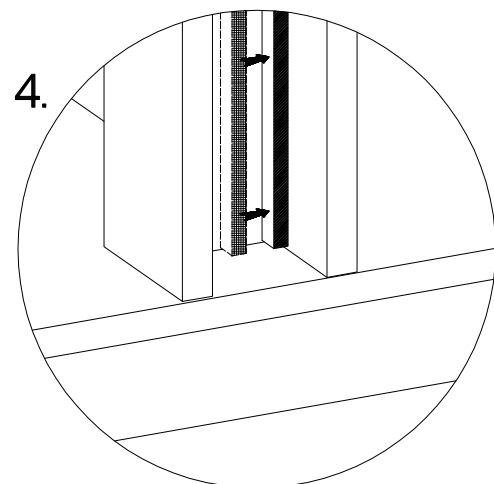
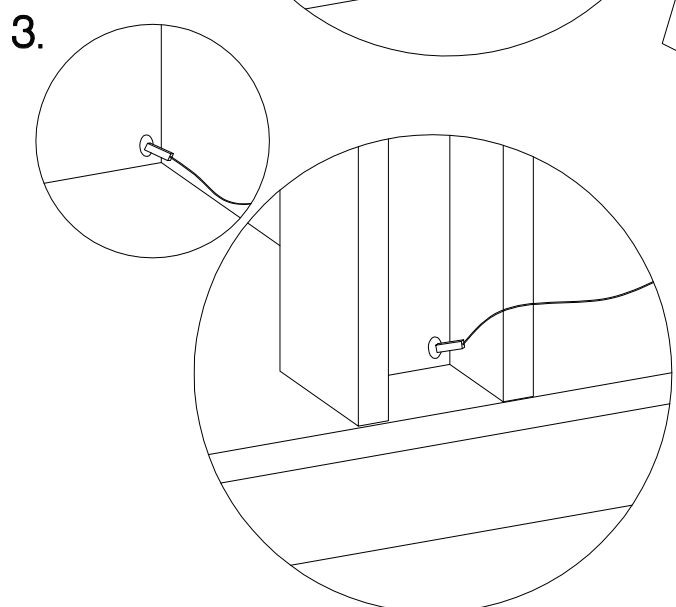
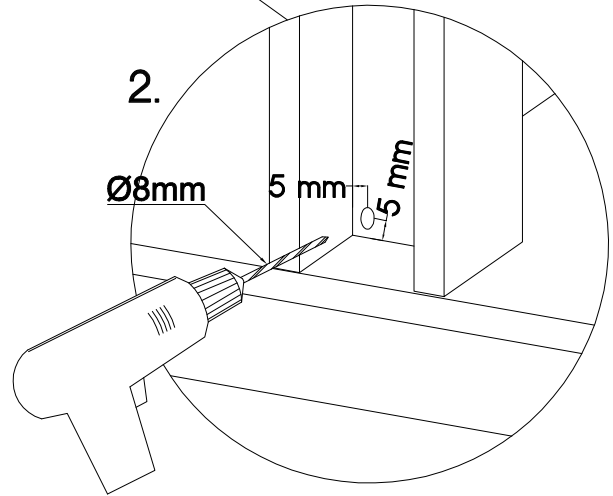
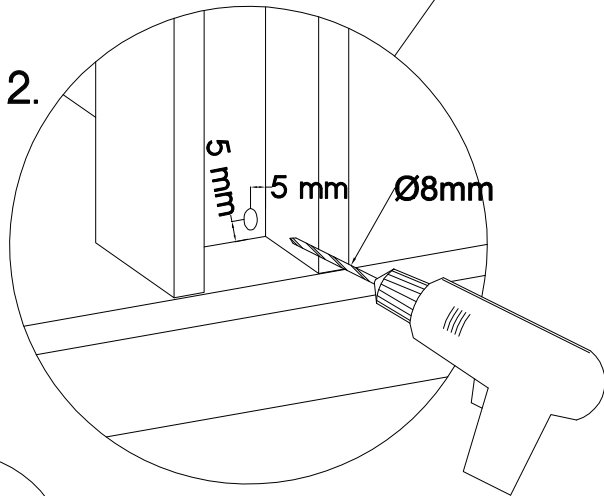
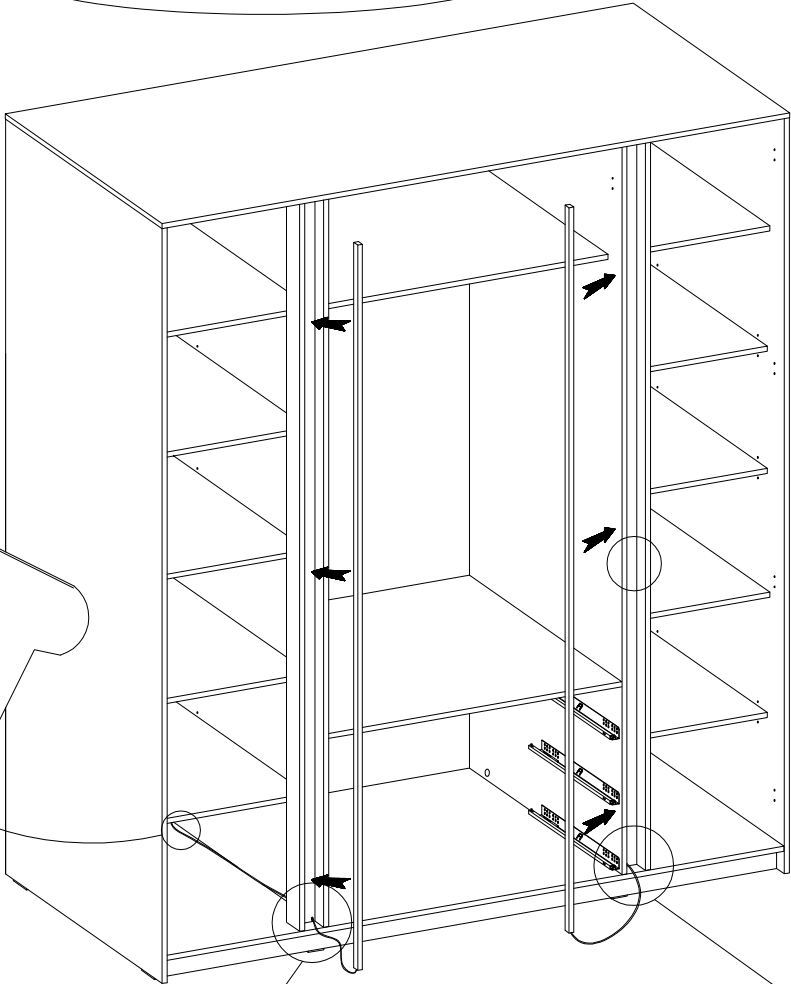
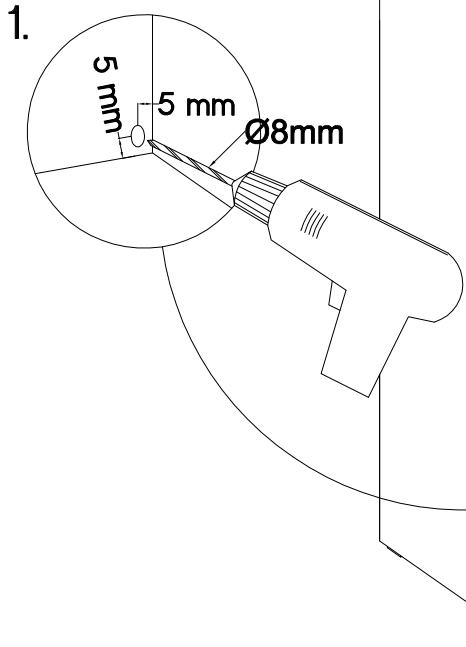
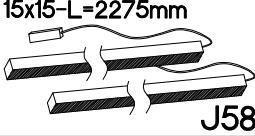



KA.A.701

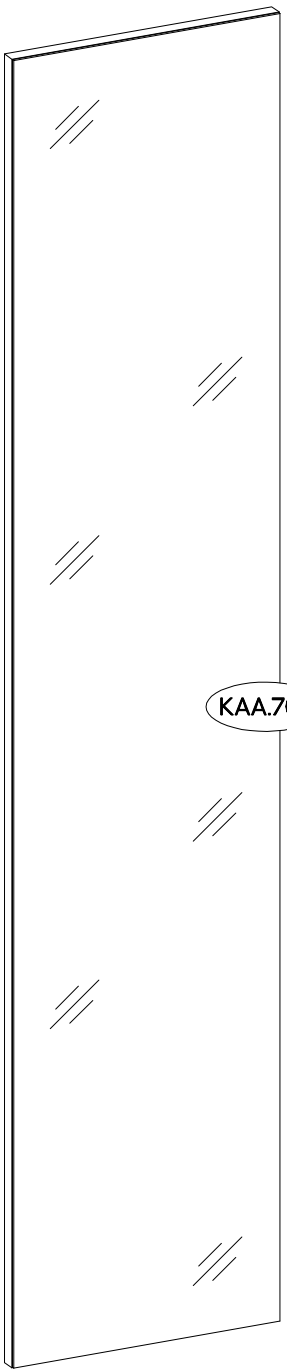

KA.A.702



KA.A.706
KA.A.904

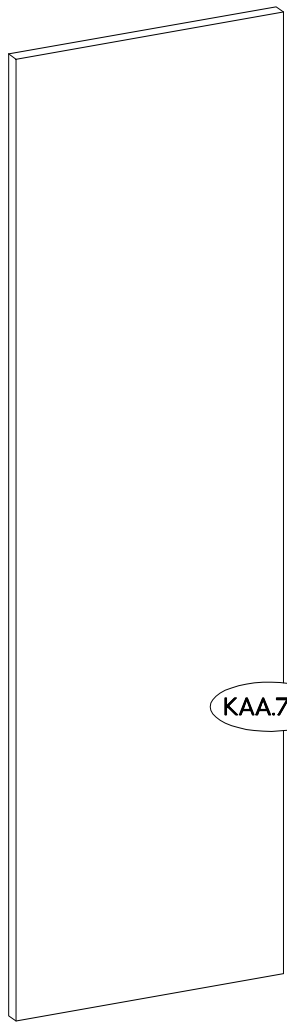

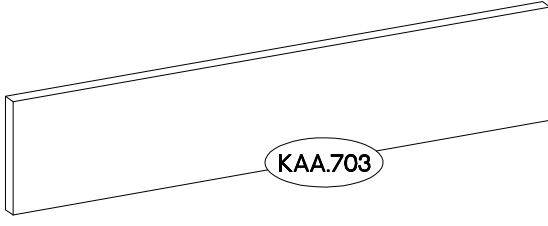

KA.A.704

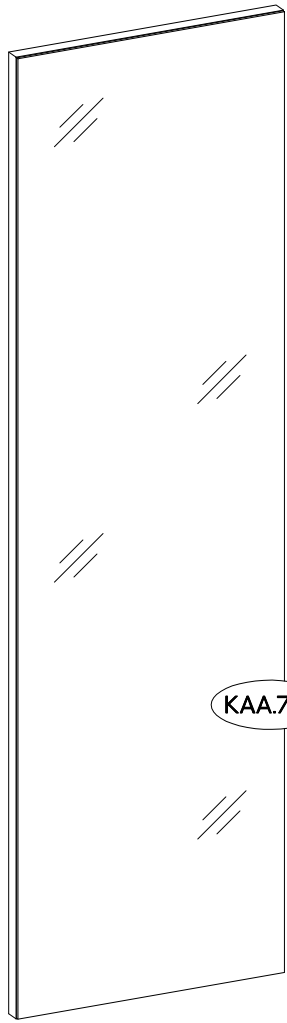

KA.A.703



KA.A.705

L=320mm	±3.0x20mm
 S	 P7
3	6

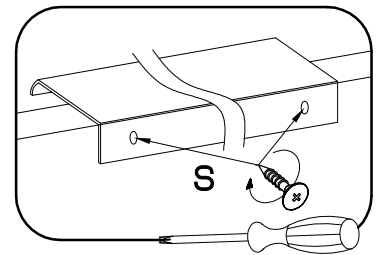
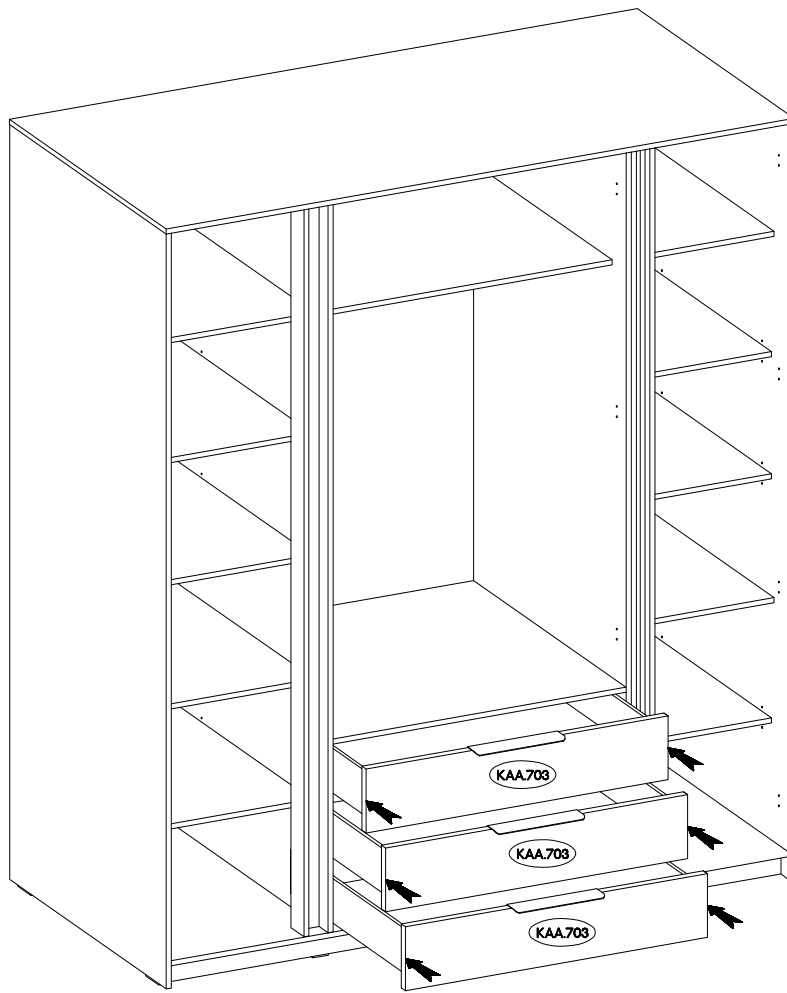

1.

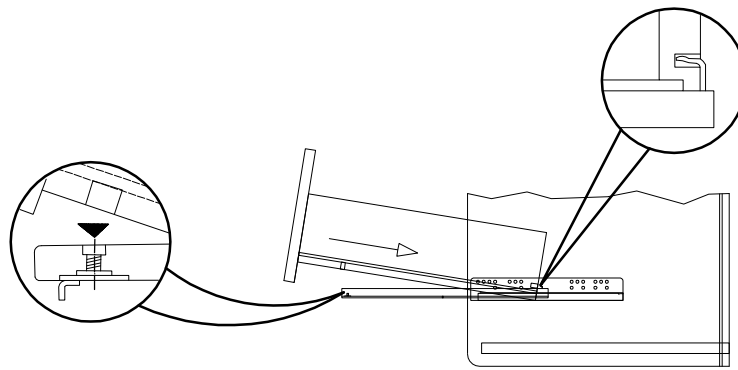

2.

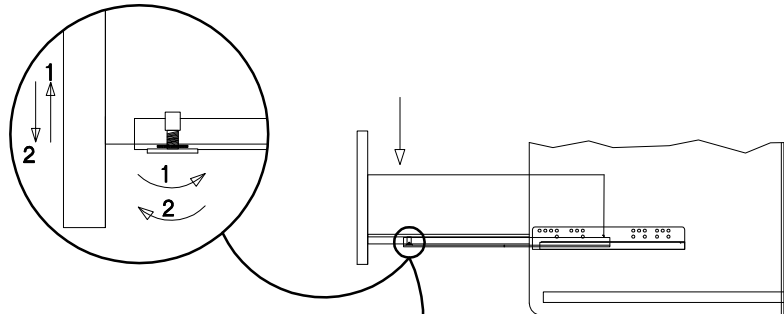

3.

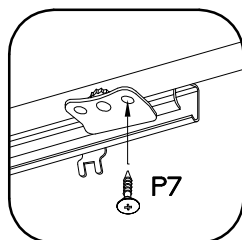

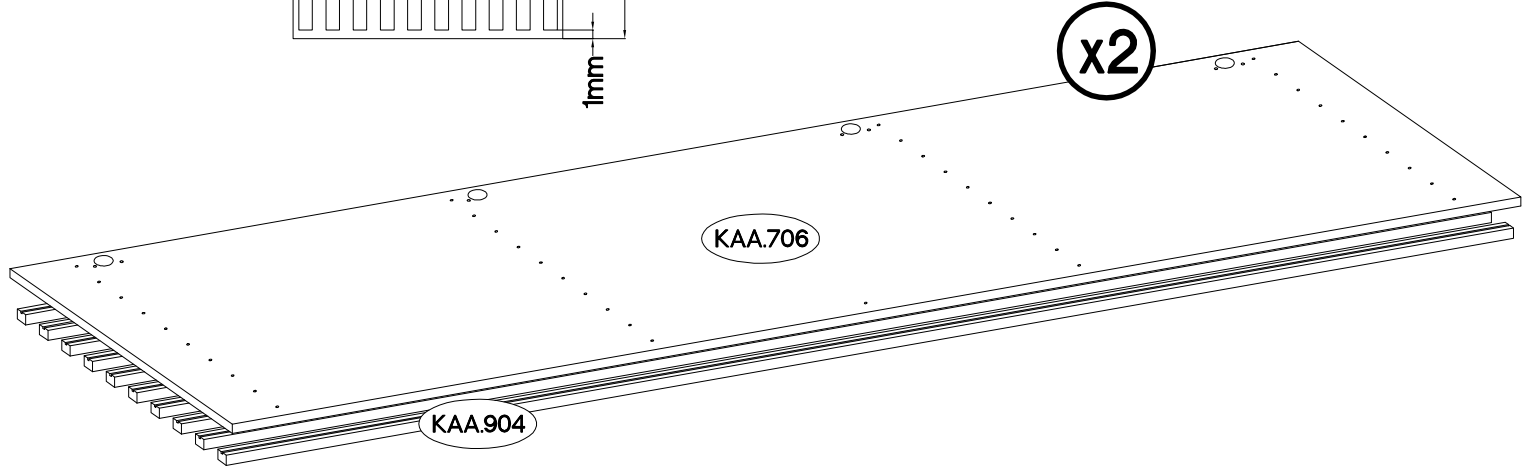
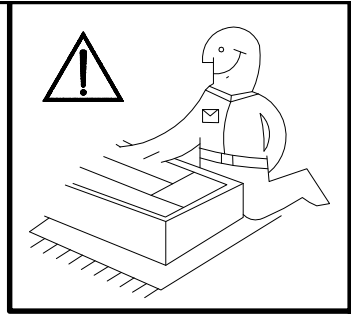
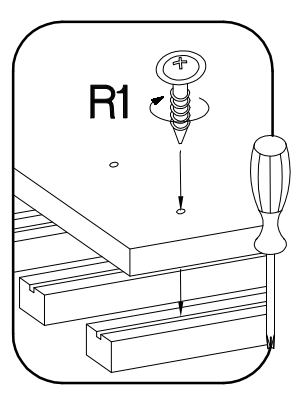
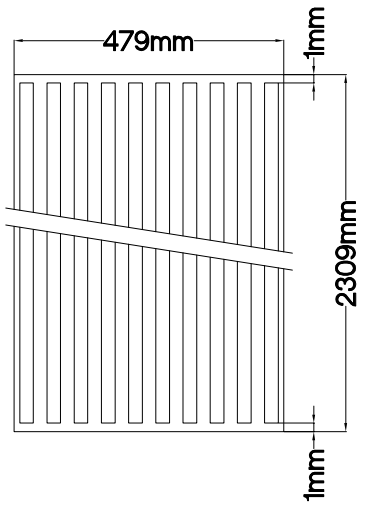

27

+4.0x27mm

R1
82

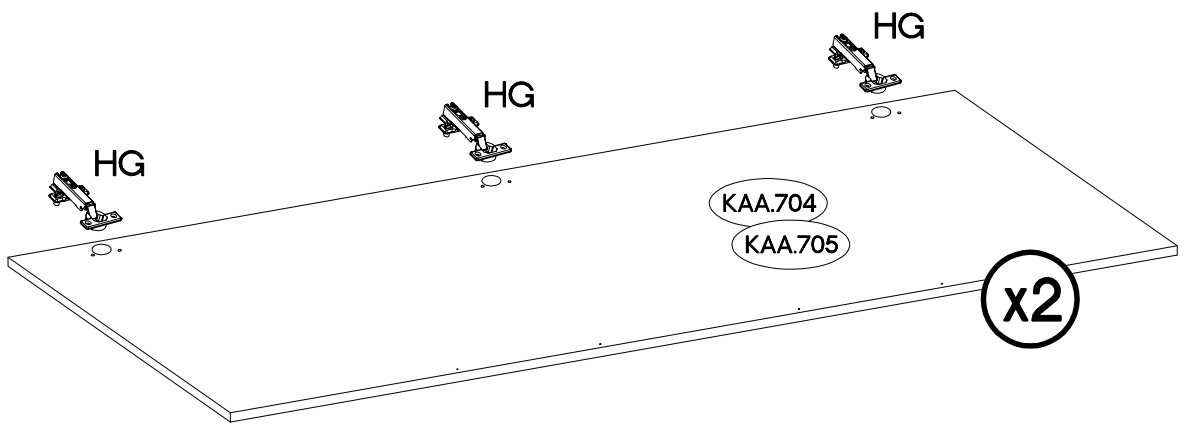
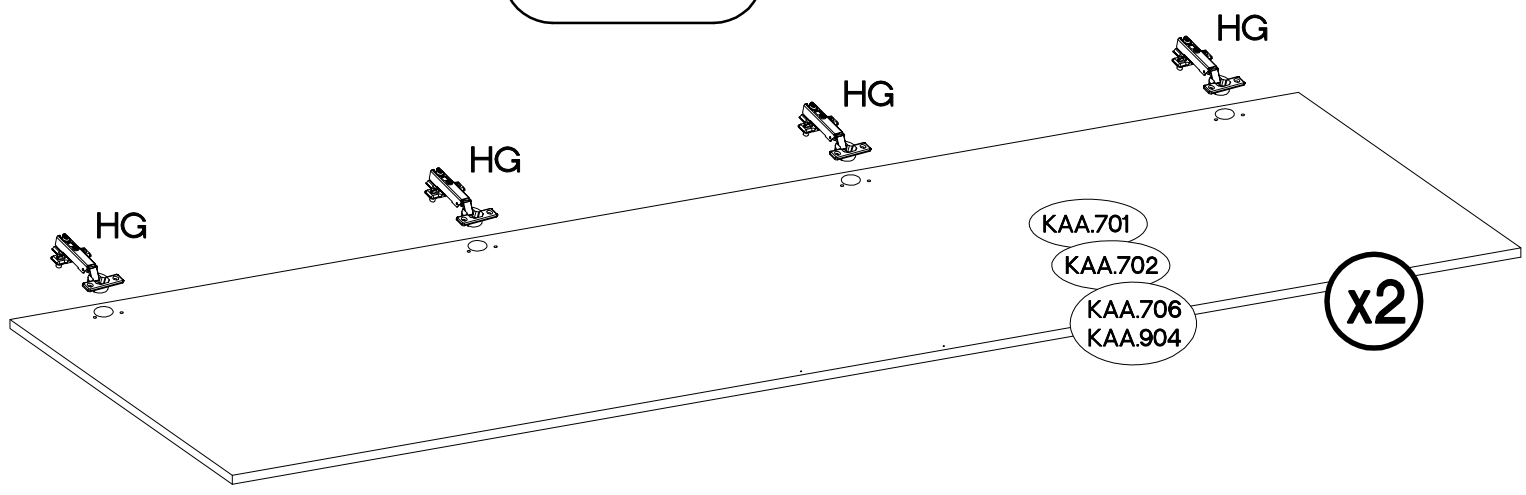
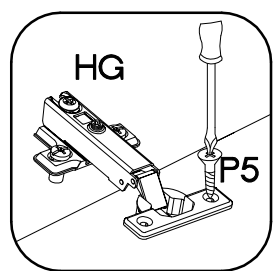

28

+35/0mm	+3.5x13mm
	
HG	P5
14	28

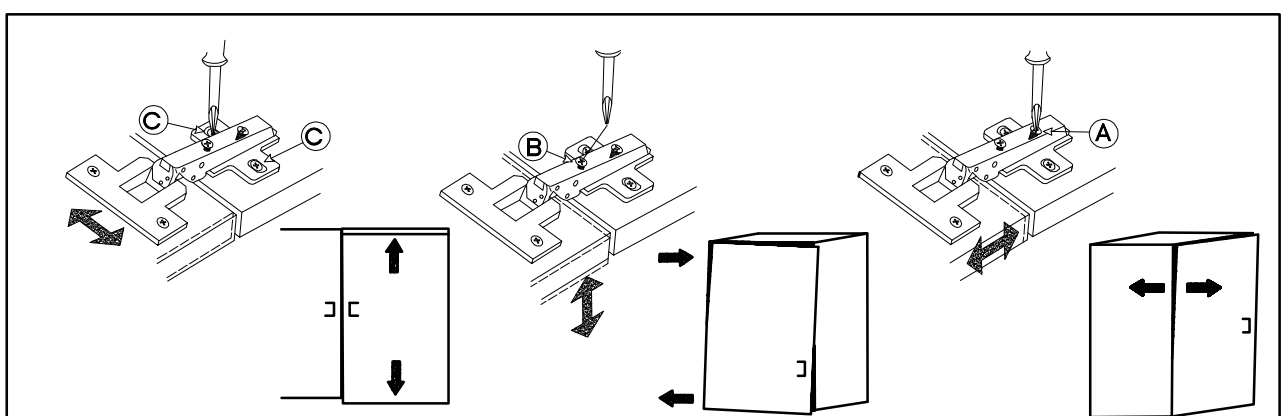
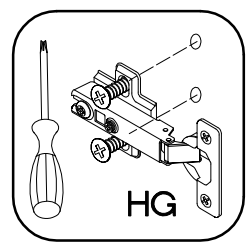
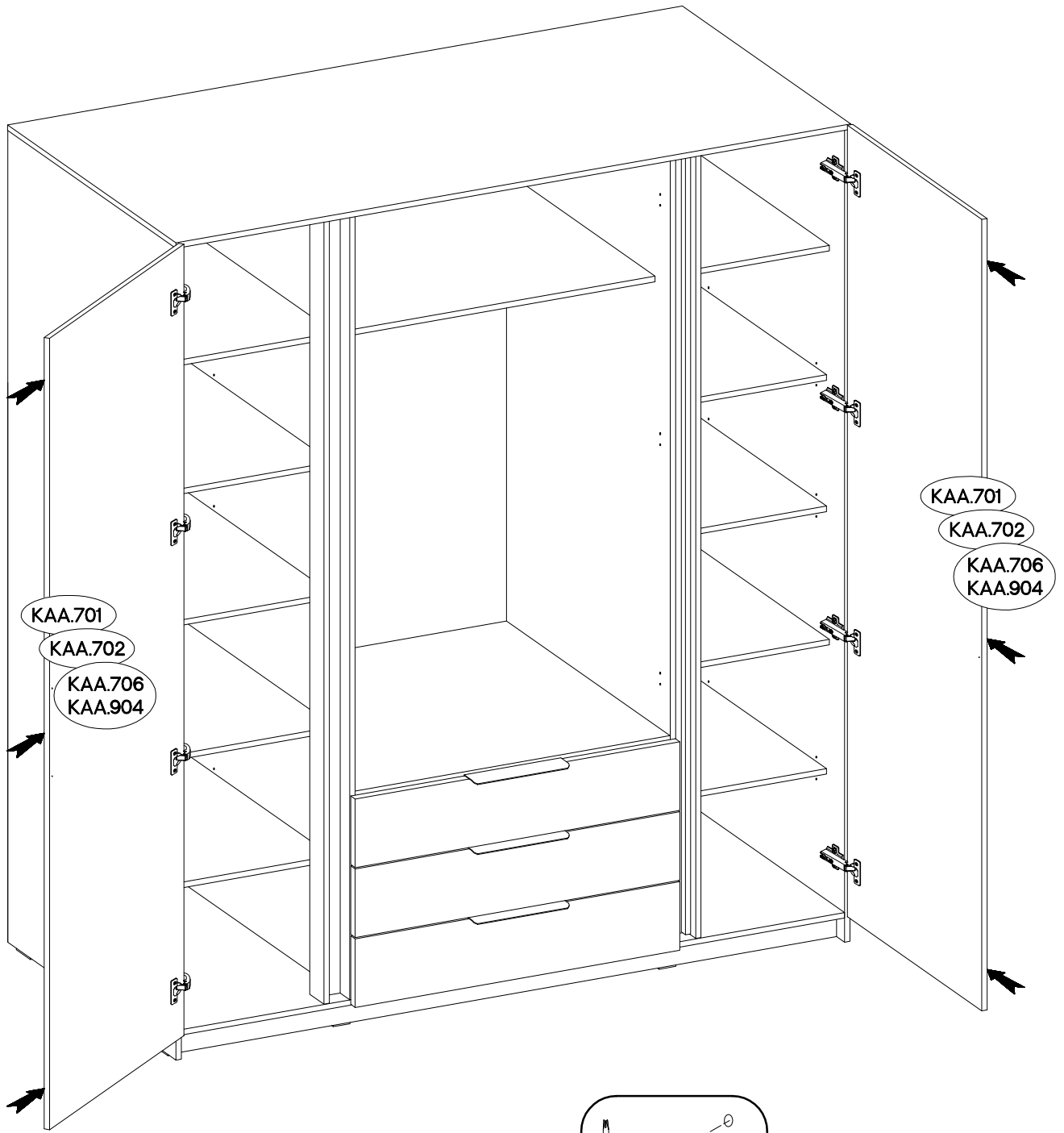



L=256mm

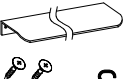

S

1

