

ANTICA 12

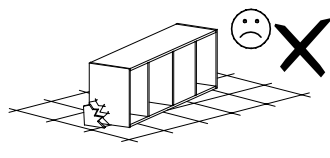

Narzędzia potrzebne do montażu

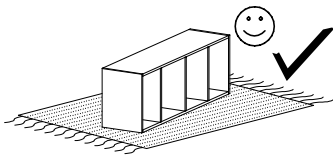
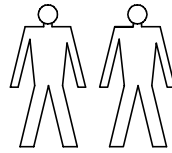
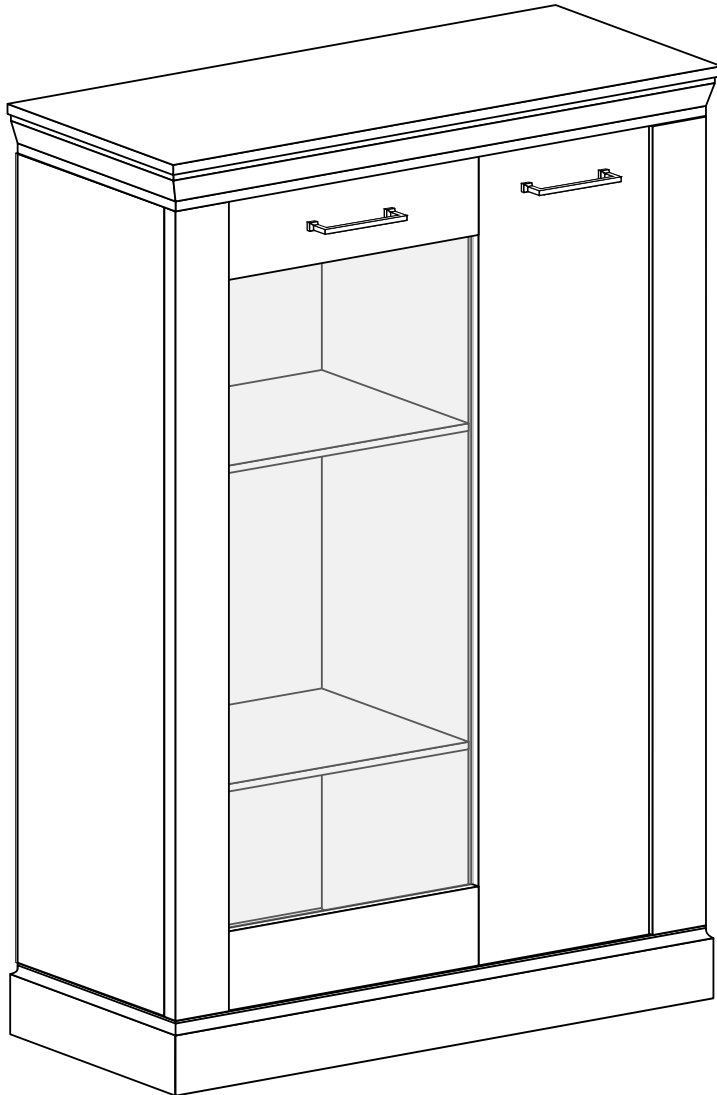
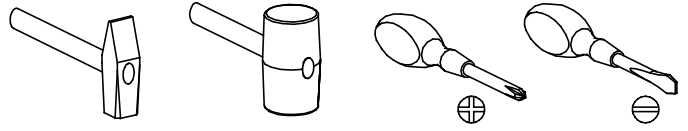

Nr	Nazwa elementu	D[mm]	S[mm]	G[mm]	Ilość
1	Błat Górny	970	420	71	1
2	Błat Dolny	940	410	80	1
3	Bok P/L	1288	380	16	2
4	Przegroda	1288	363	16	1
5	Listwa P/L	1285	100	32	2
6	Półka	482	350	16	2
7	Półka	377	360	16	2
8	Kapak	1315	398	16	1
9	Kapak	1315	500	16	1
10	Drzwi	1225	300	16	2
11	Drzwi G/D	400	120	16	2
12	Szyba Drzwi	1020	393	4	1

UWAGA !!!

MONTOWANIE USZKODZONYCH
ELEMENTÓW POWODUJE UTRATĘ
GWARANCJI

W przypadku reklamacji proszę podać numer pakowacza znajdujący się na kartonie.

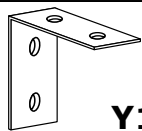

Y1 - 2 St.

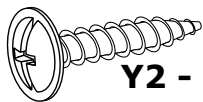

Y2 - 4 St.
3,5x16 mm

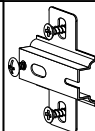

W1 - 2 St.

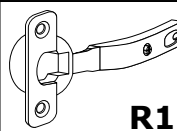

R1 - 2 St.

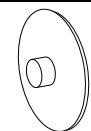

X1 - 14 St.



F - 6 St.

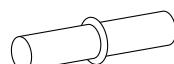

P - 16 St.

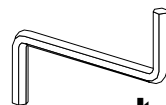

Ł - 1 St.

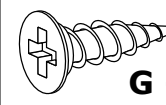

G - 24 St.
3,5x16 mm

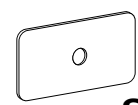

S - 10 St.

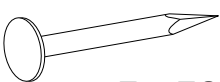

E - 50 St.



A - 4 St.
7x50 mm

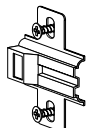

W2 - 2 St.

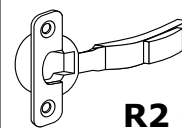

R2 - 2 St.

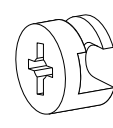

L - 18 St.



B - 16 St.
8x35 mm

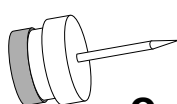

Q - 5 St.

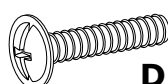

D - 4 St.
4x25 mm



U - 2 St.

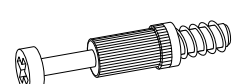

K - 18 St.

I

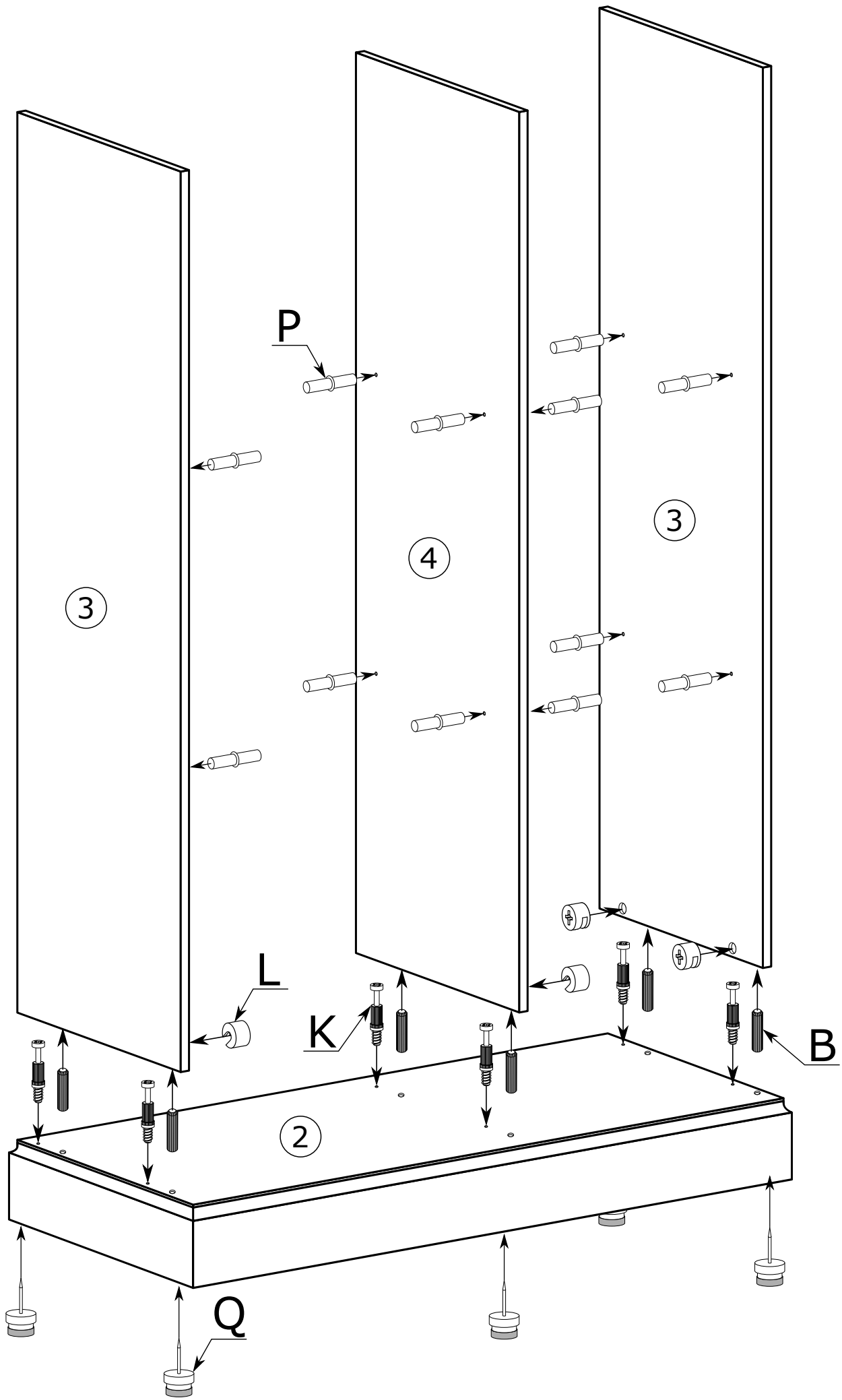

II

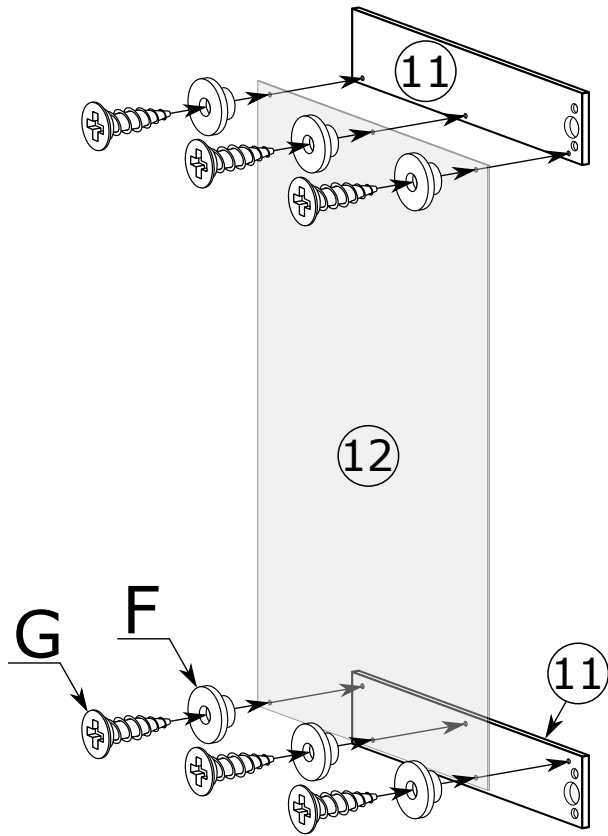

III

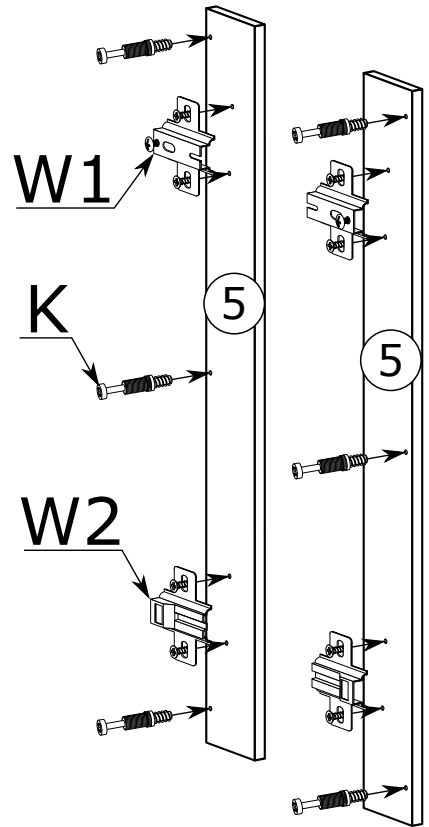

IV

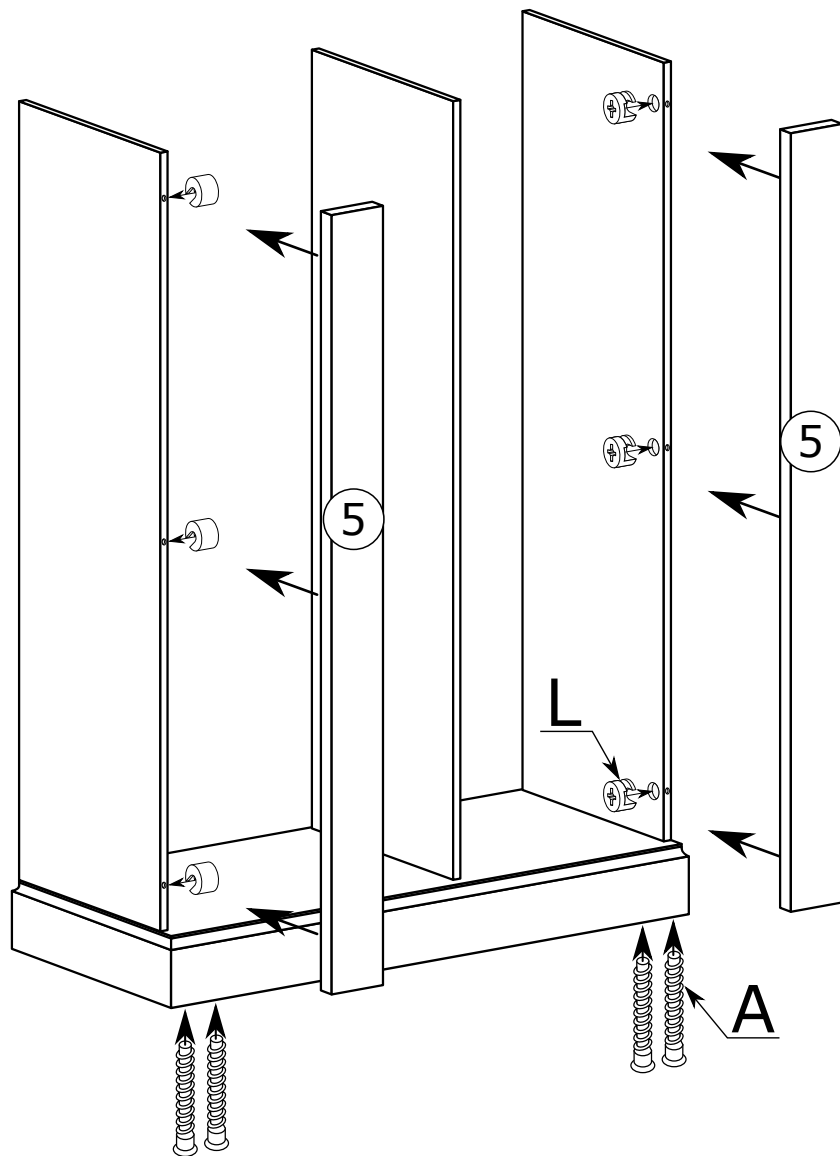

V

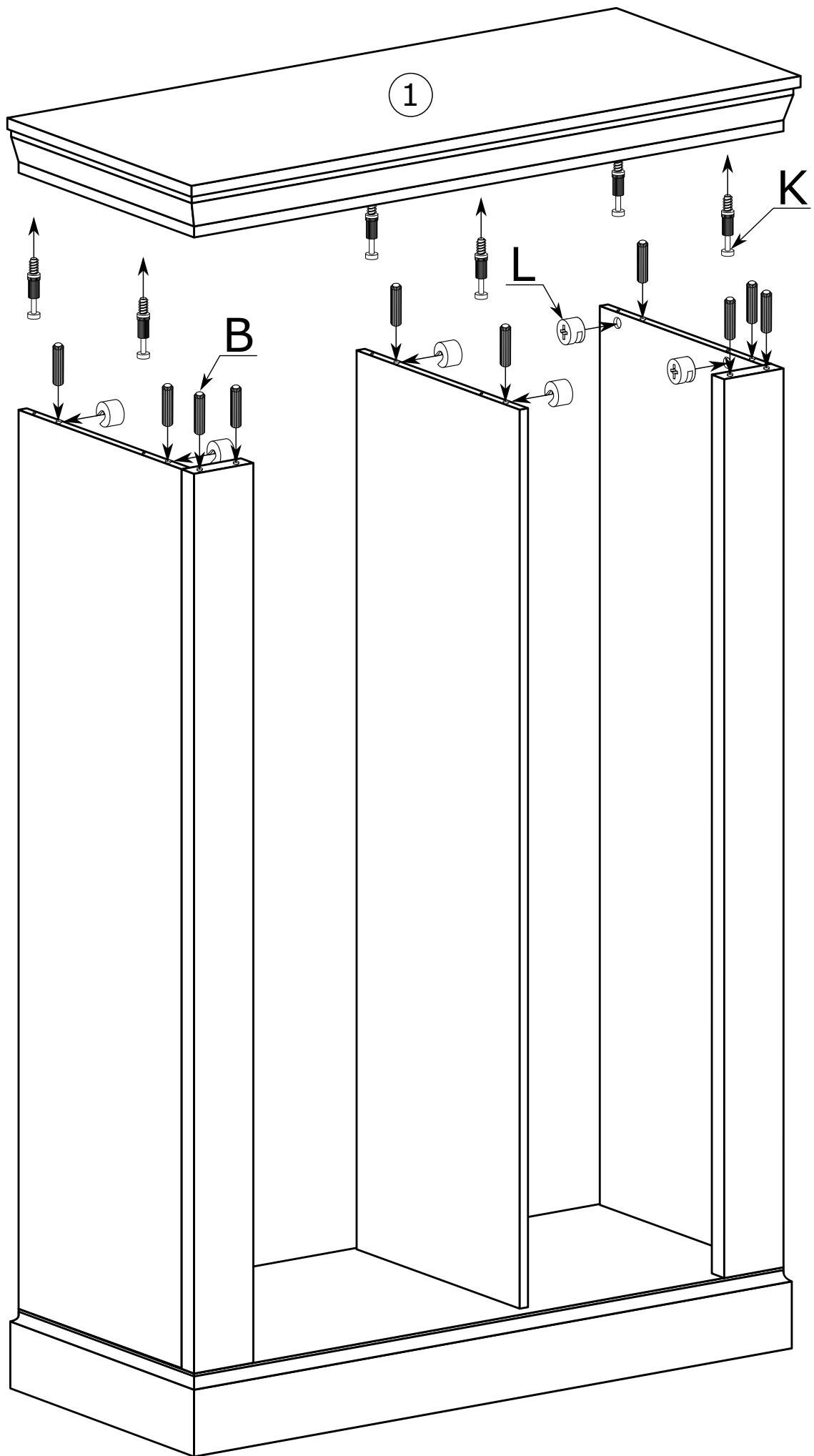

VI

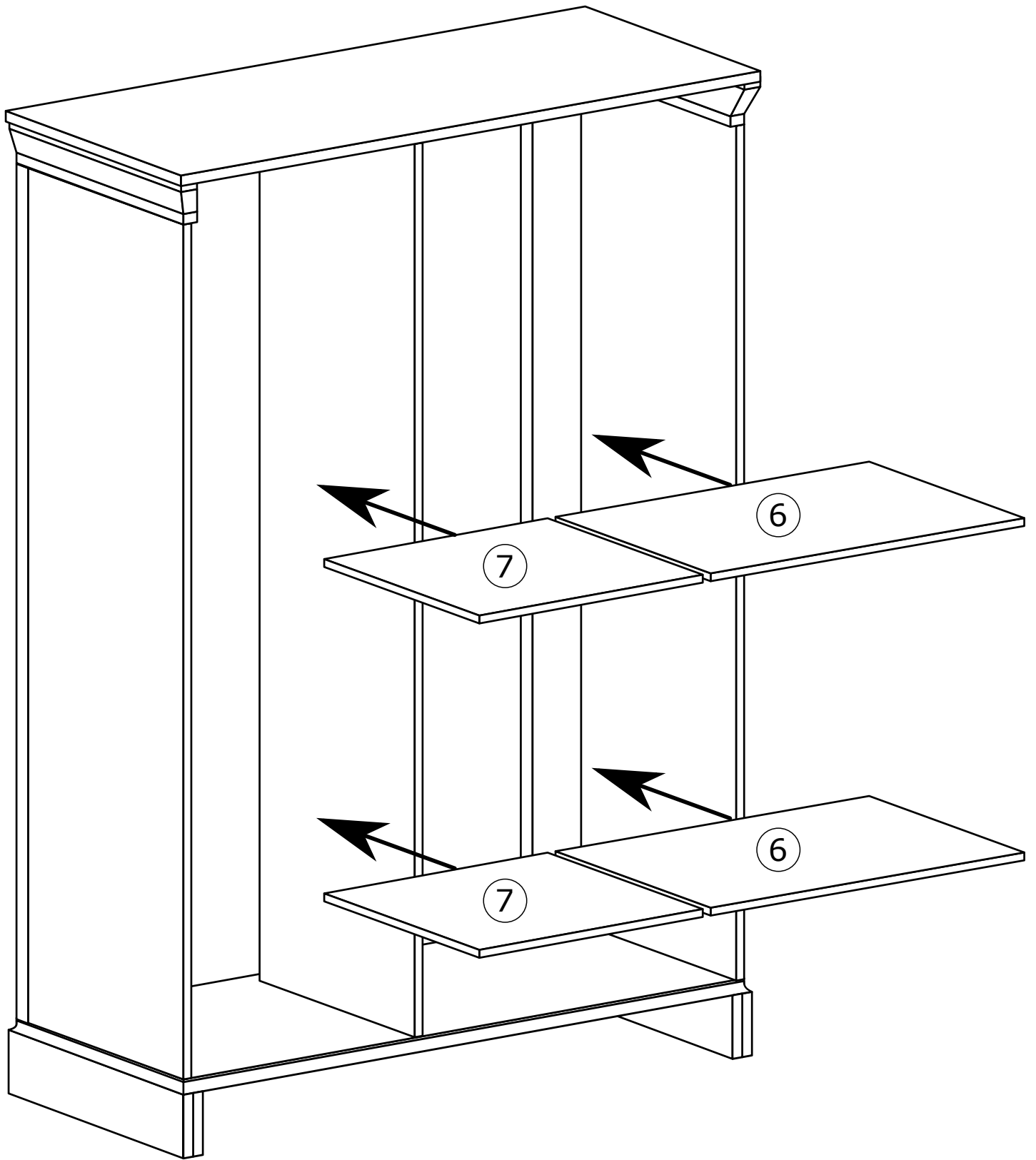

VII

x50

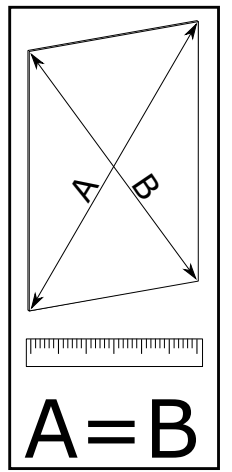
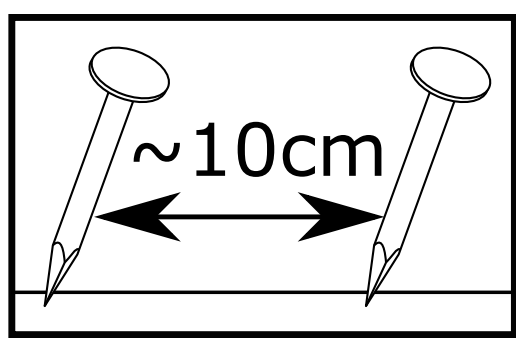
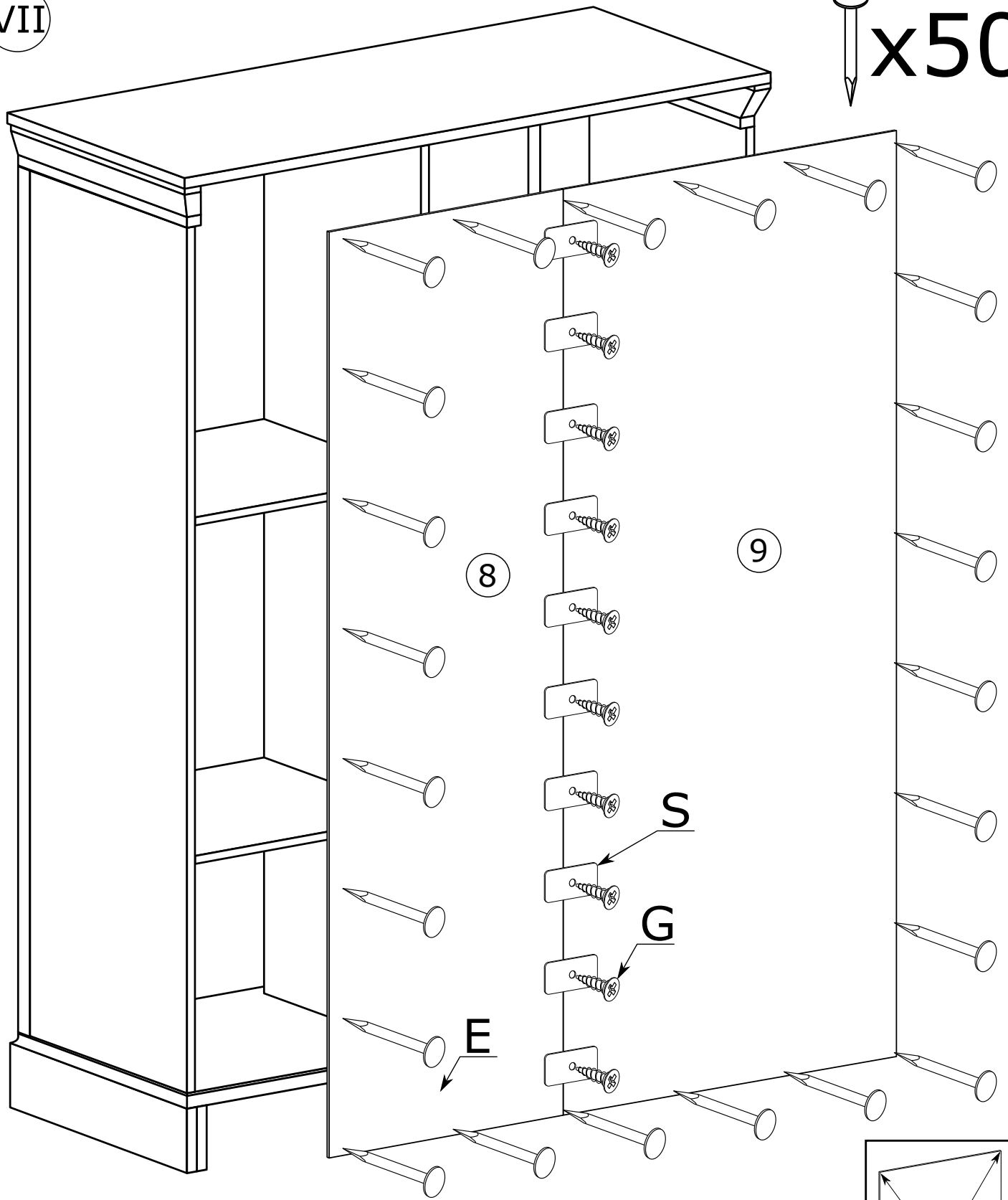

VIII

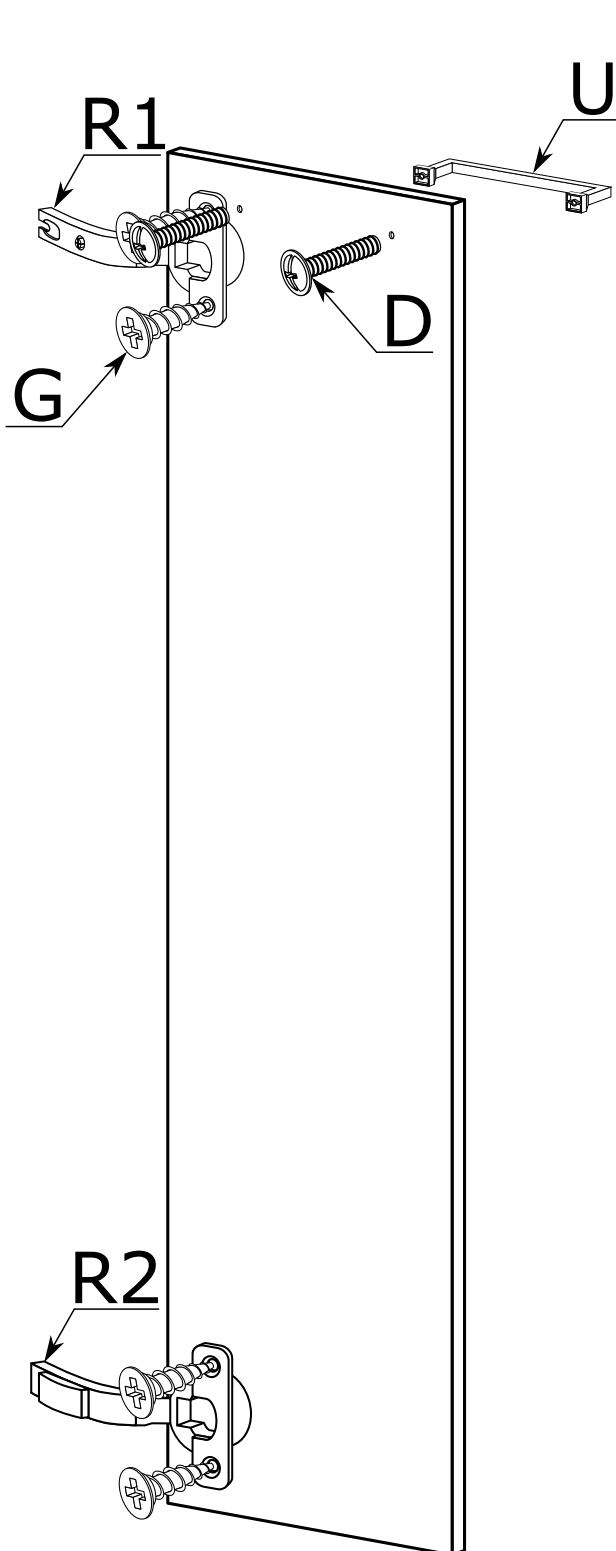
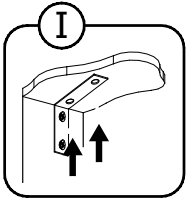
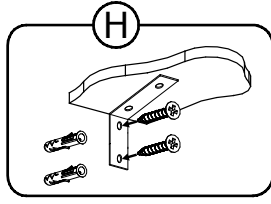
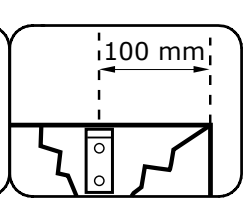
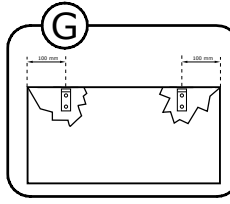
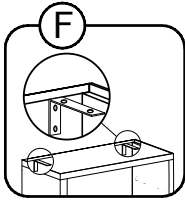
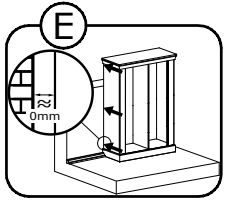
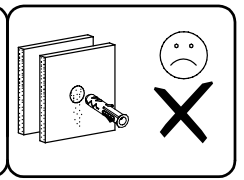
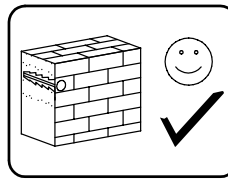
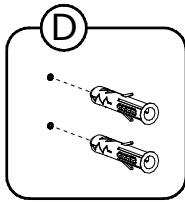
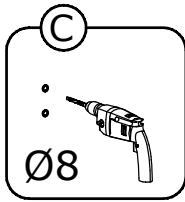
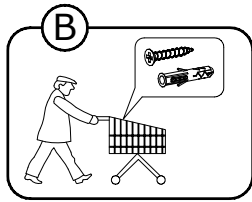
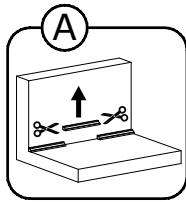

IX

