

MALTA
TYP 109

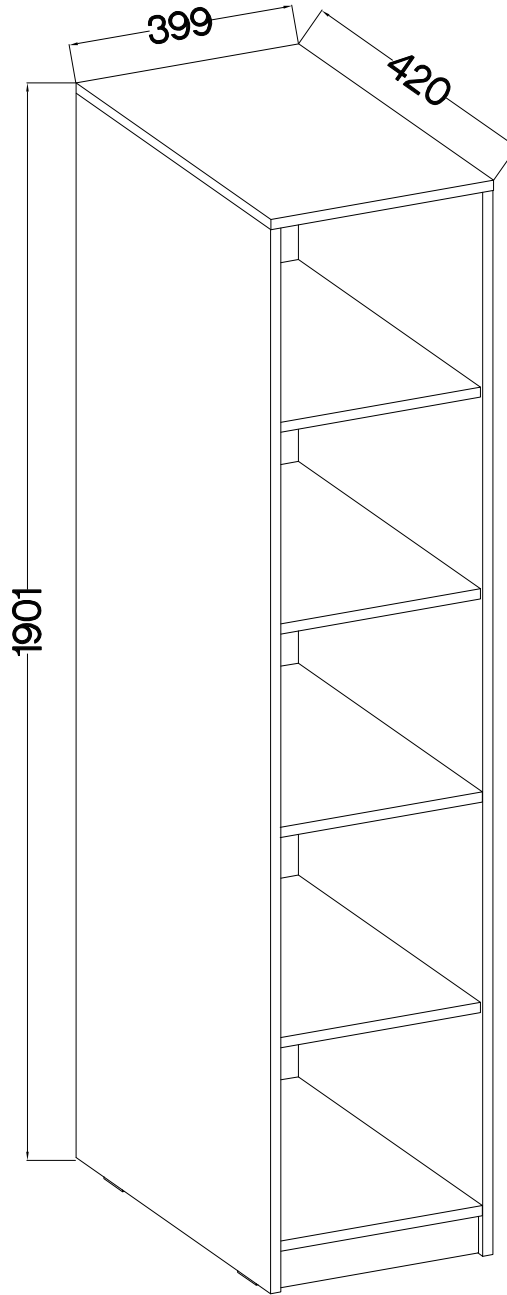
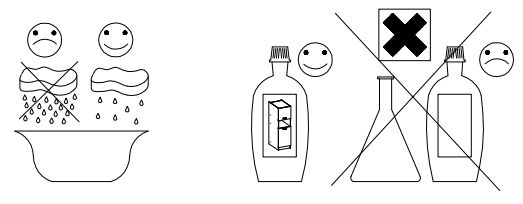

+8x30mm
A
16

+15/12mm	L=20mm
C	D2
12	12

+20
E11
8

6.5x48x16
F2
4

+5/16mm
J3
12

L
16

L9
1

+5
M10
2

+10x50mm
O7
1



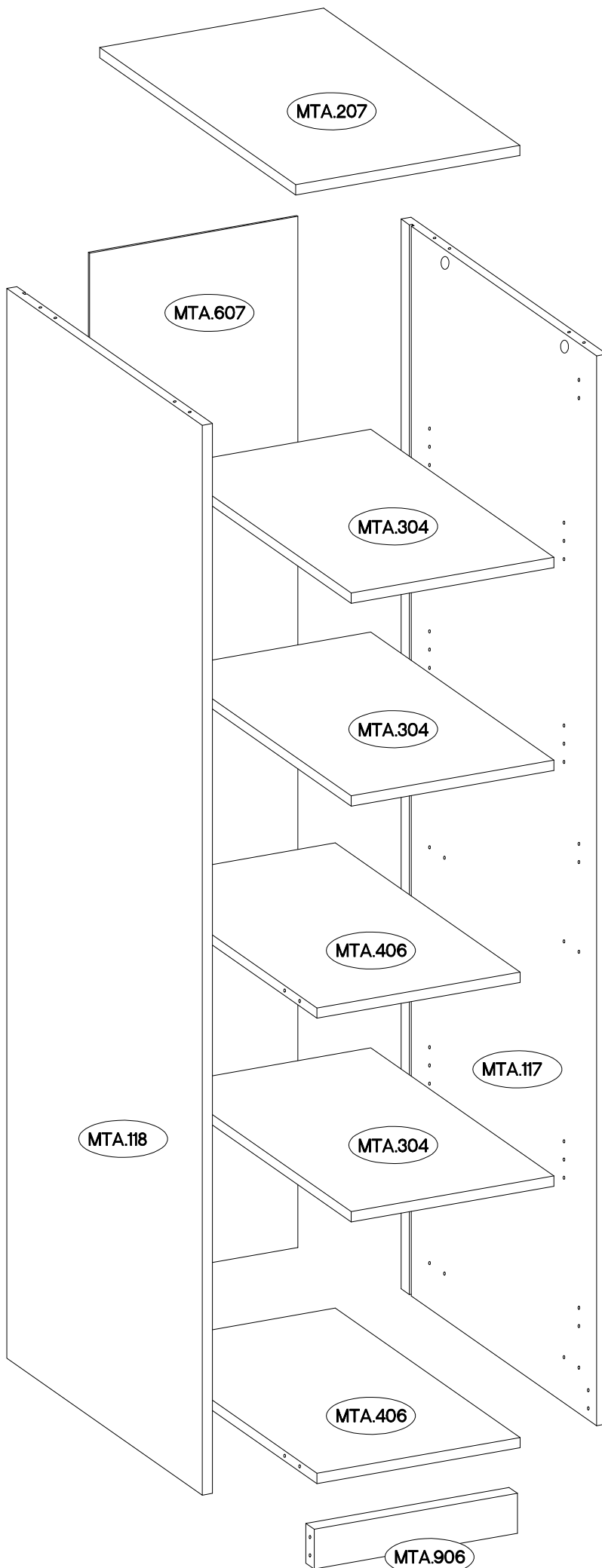

+3.5x13mm
P5
1

+3.0x20mm
P7
6

ISM-MTA-12



Ersatzteil Nummer	Dimension
MTA.117	1878x419x18
MTA.118	1878x419x18
MTA.207	399x420x18
MTA.304 x3	361x392x18
MTA.406 x2	362x396x18
MTA.607	1810x371x2,5
MTA.906	362x70x18

$\varnothing 8 \times 30 \text{mm}$  A 16	$6.5 \times 48 \times 16$  F2 4	$L=20 \text{mm}$  D2 12	$\varnothing 15 / 12 \text{mm}$  C 12
--	--	--	--

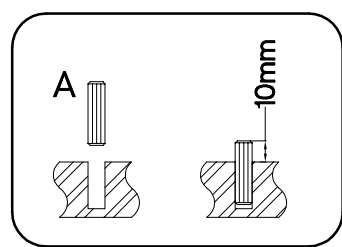
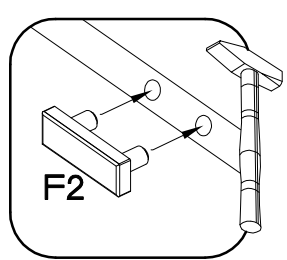
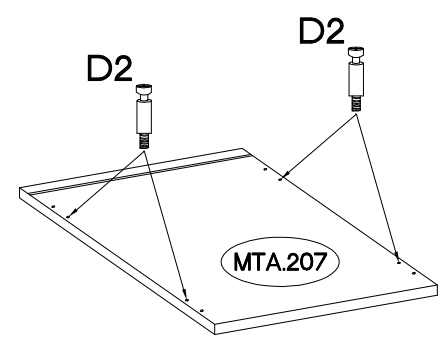
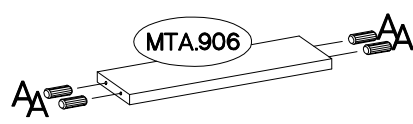
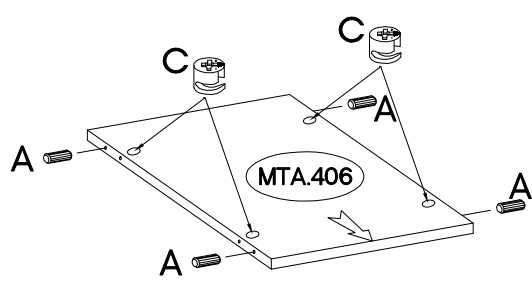
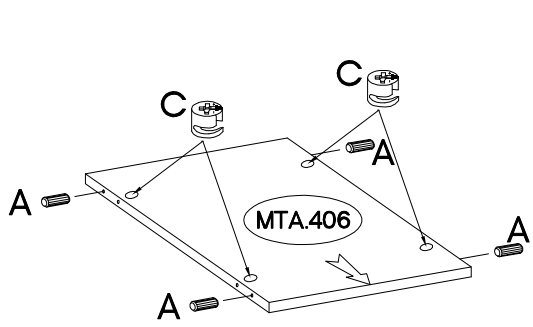
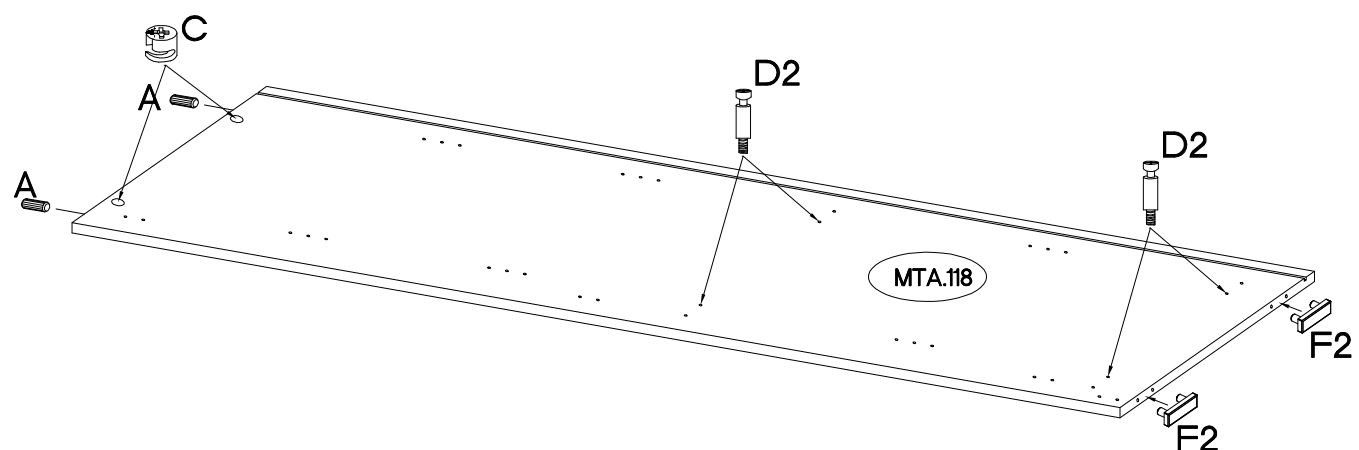
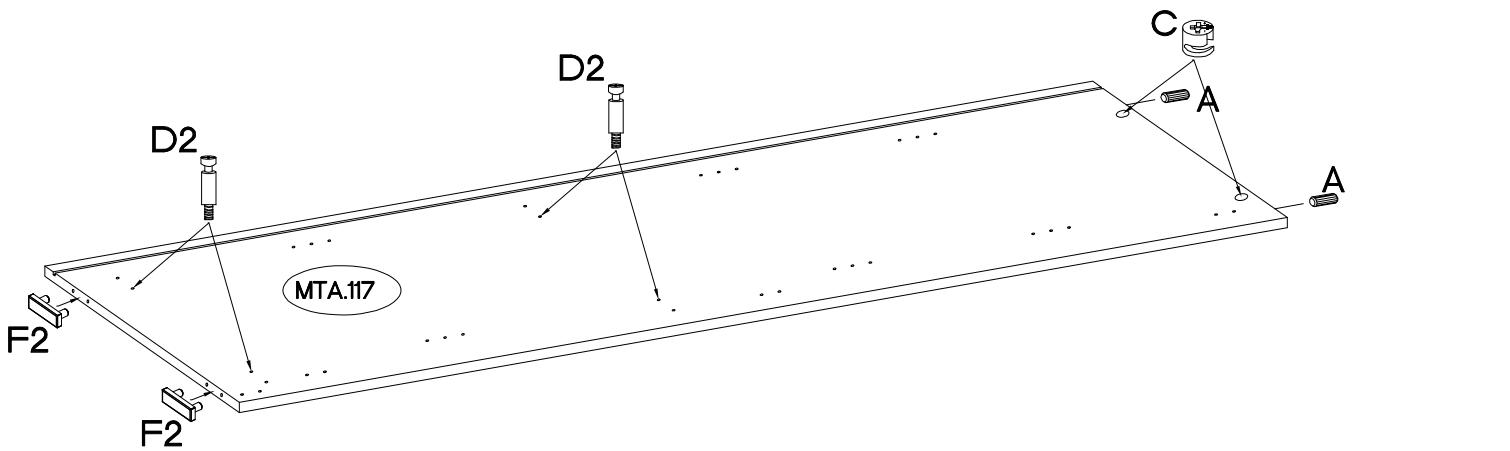
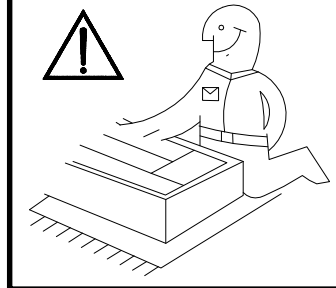
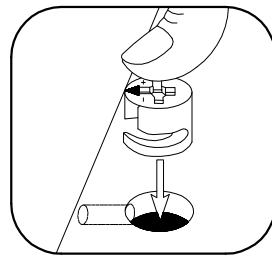

2

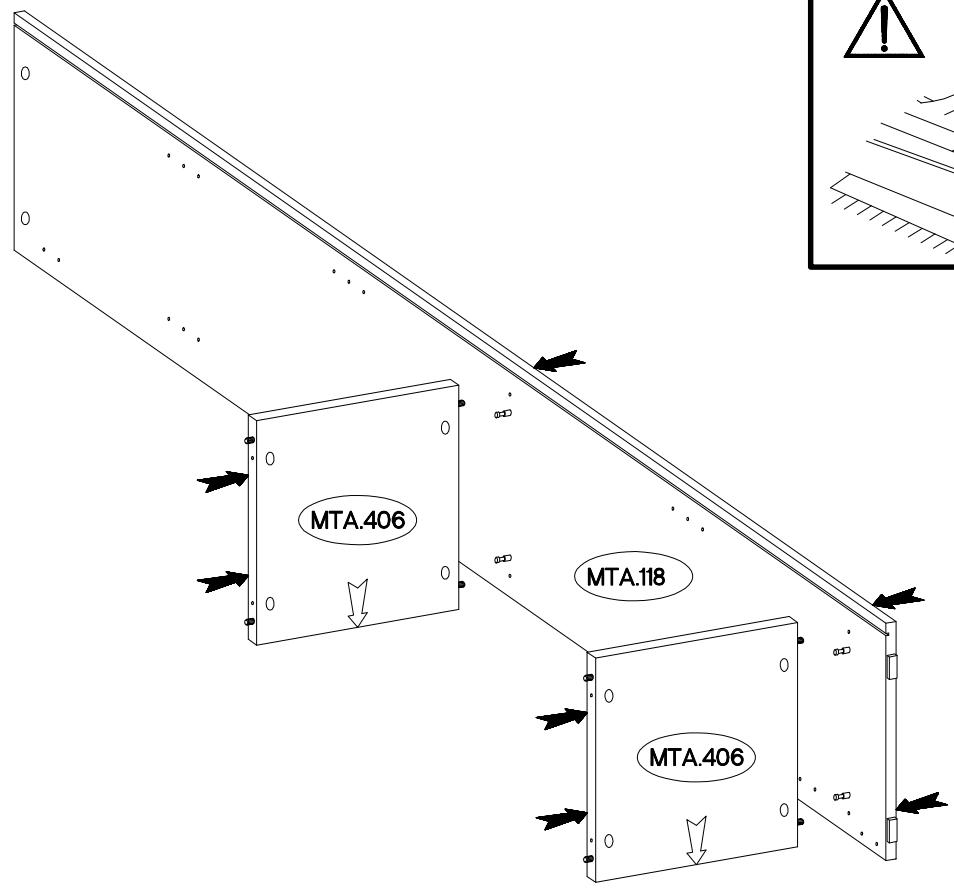

3

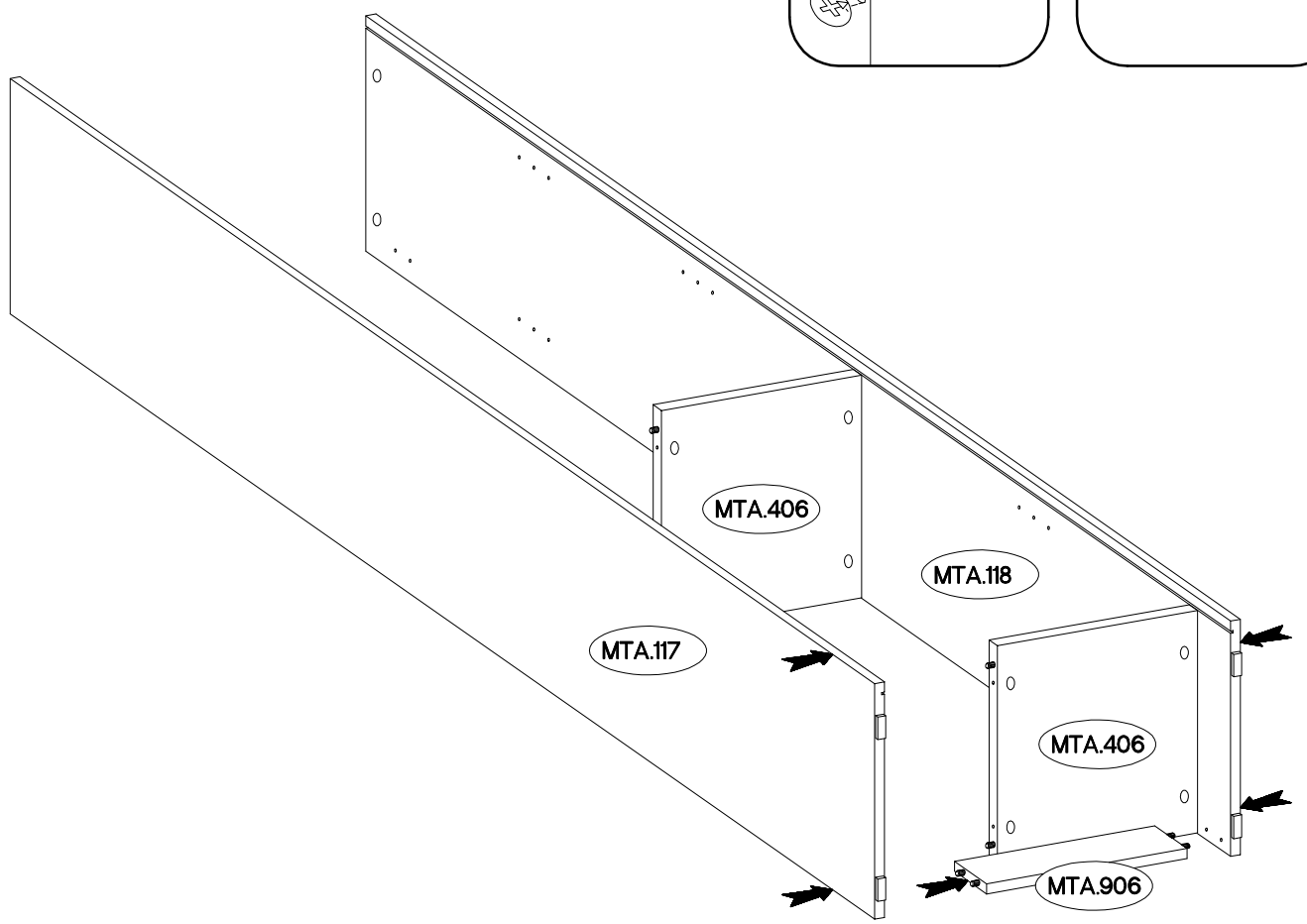

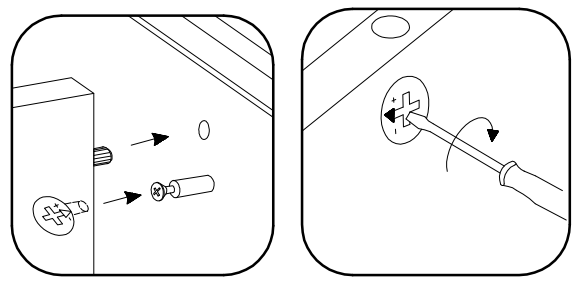
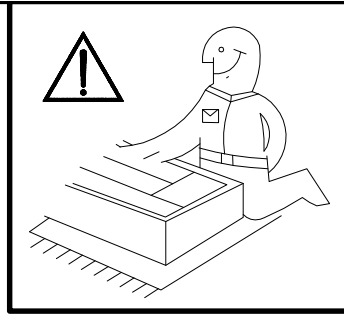
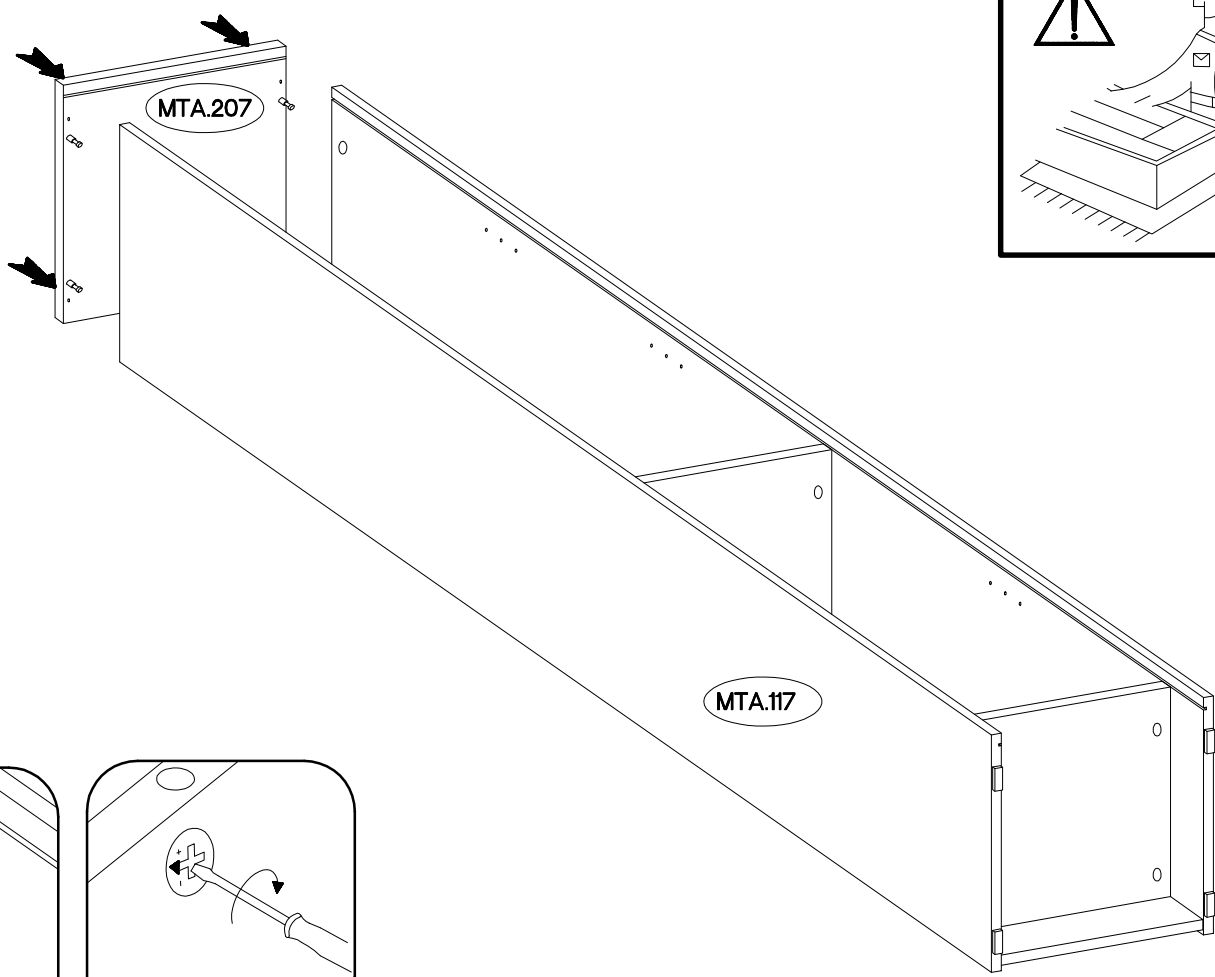

4



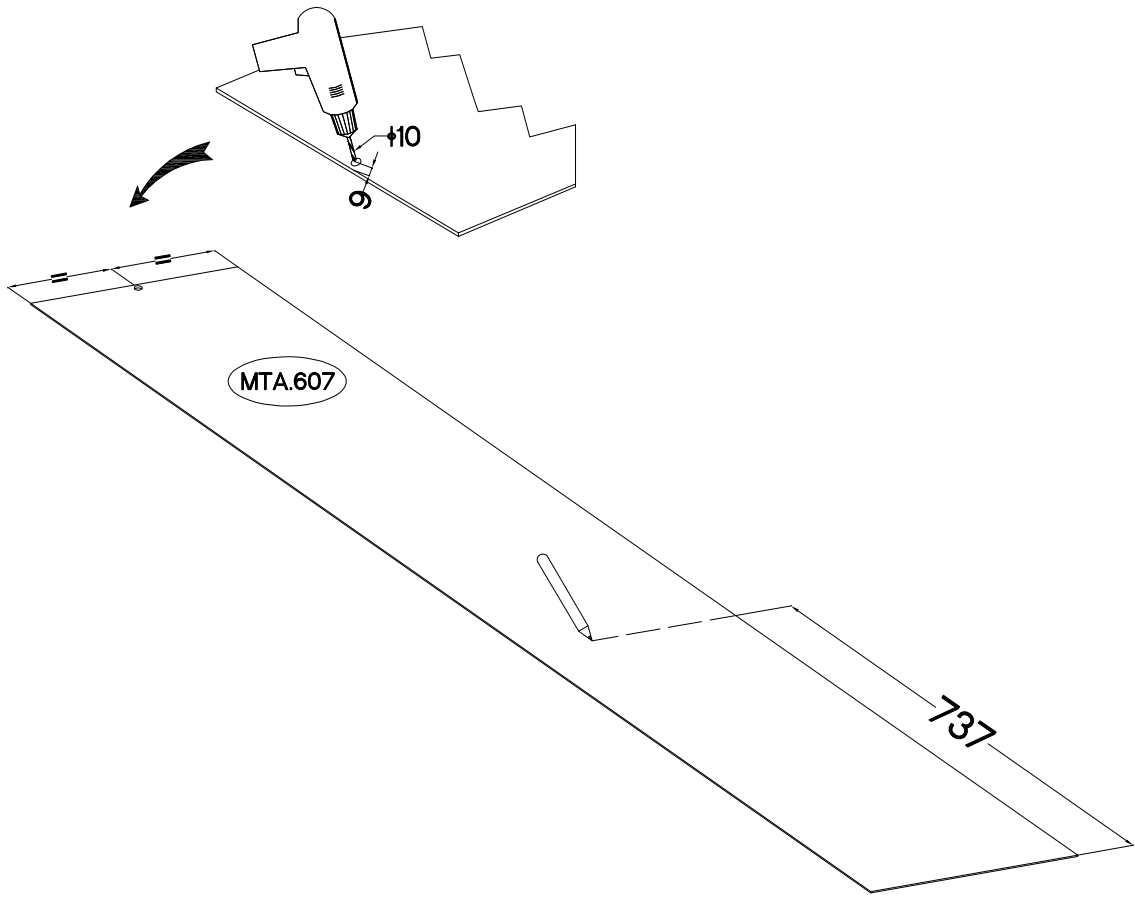

5



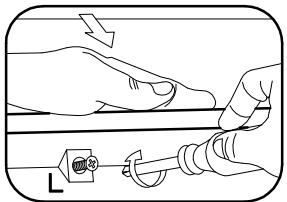
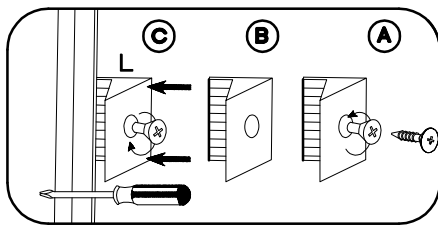
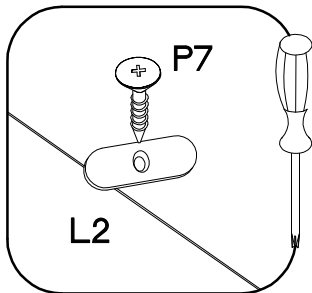
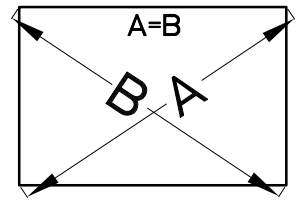
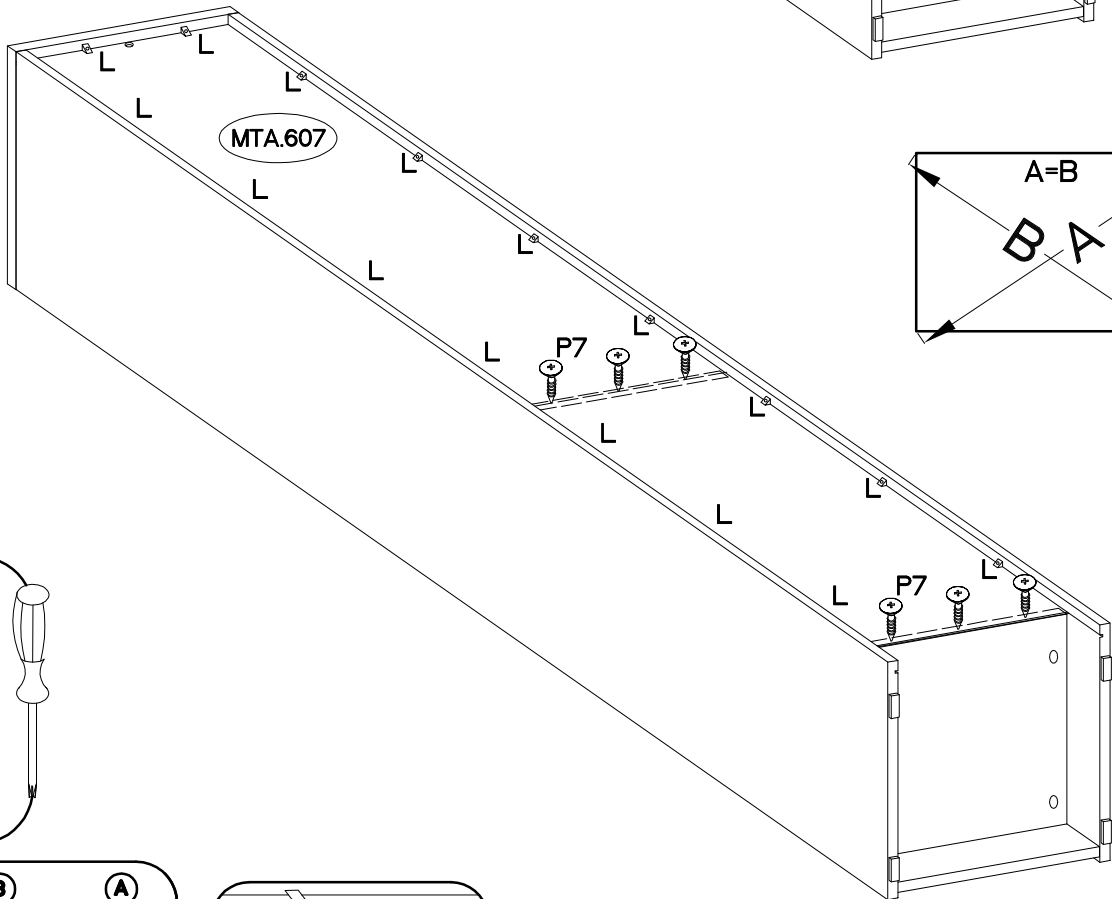
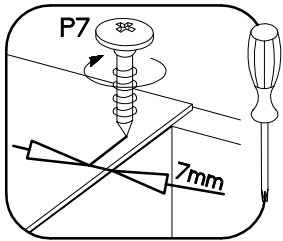
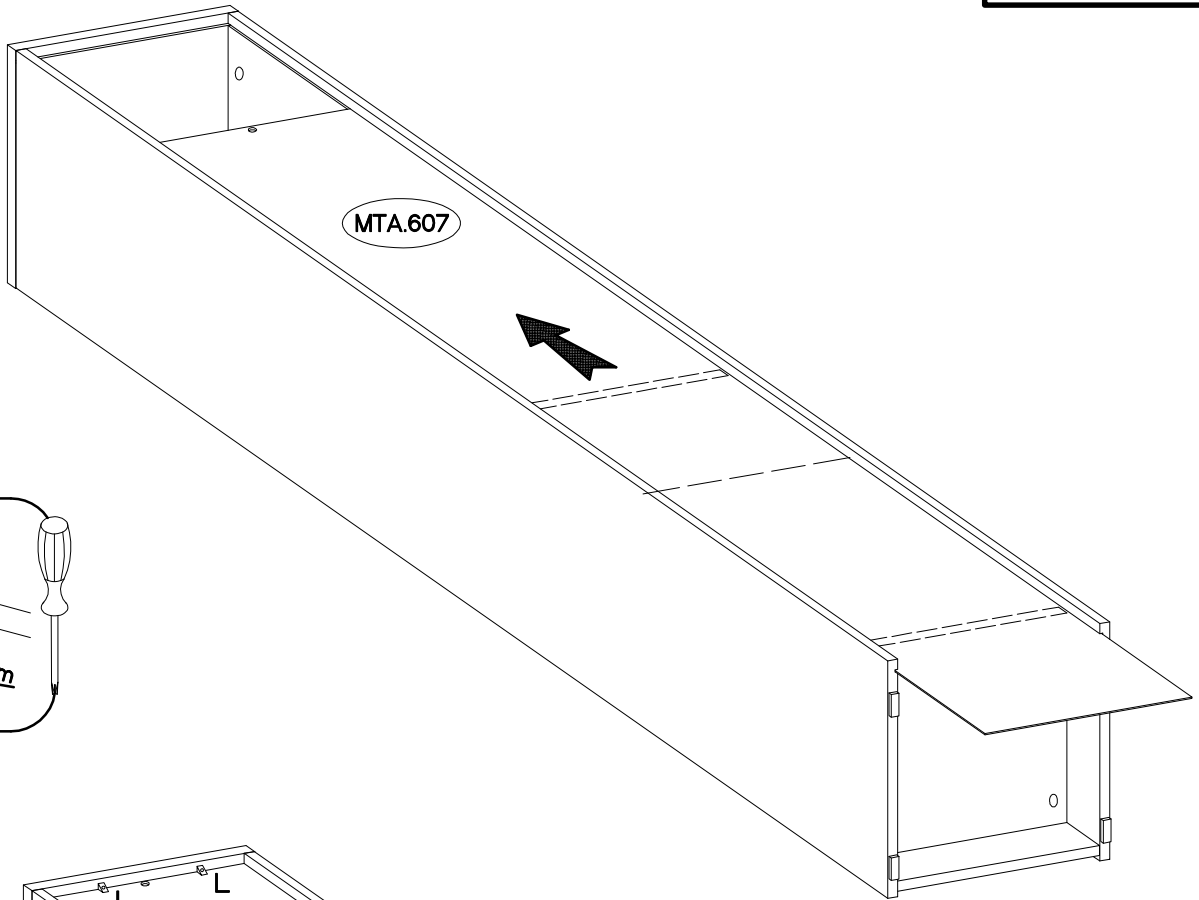
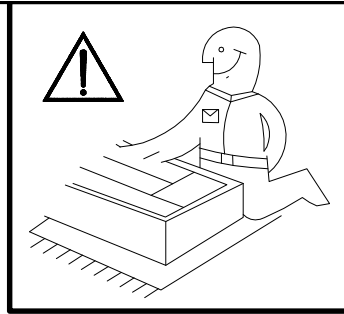

<p>±3.0x20mm</p>  <p>P7</p> <p>6</p>	 <p>L</p> <p>16</p>
---	---

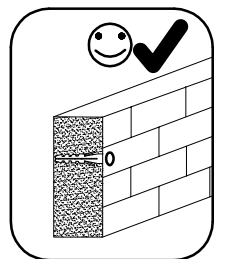
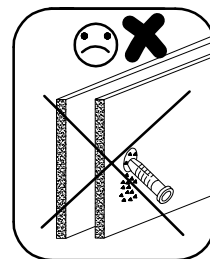
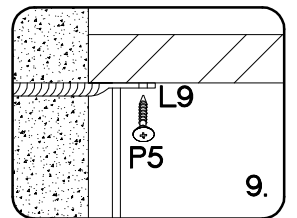
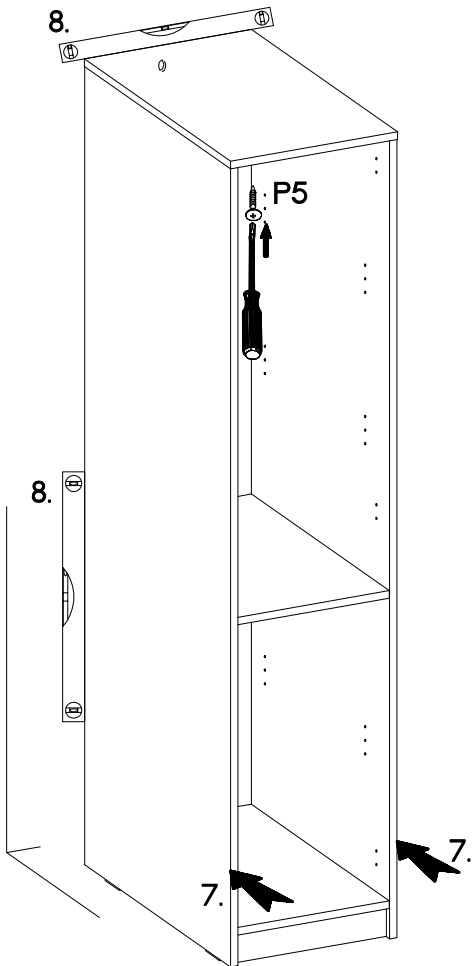
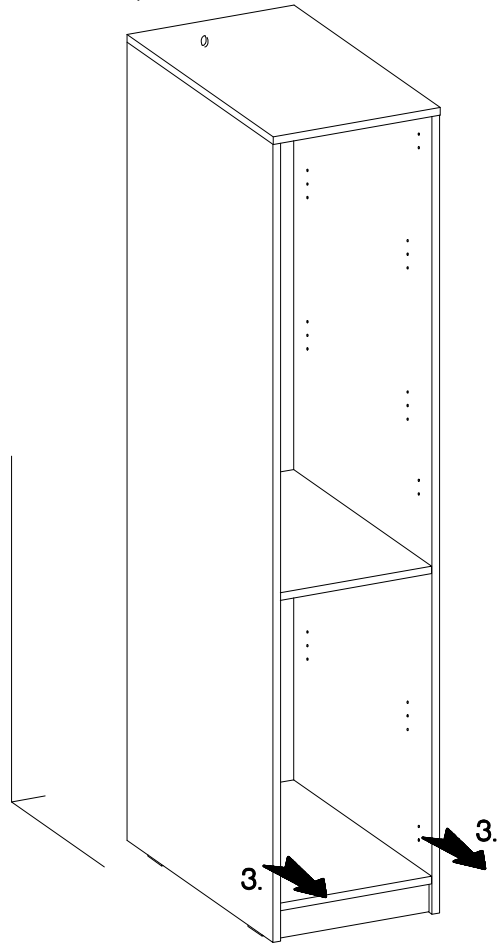
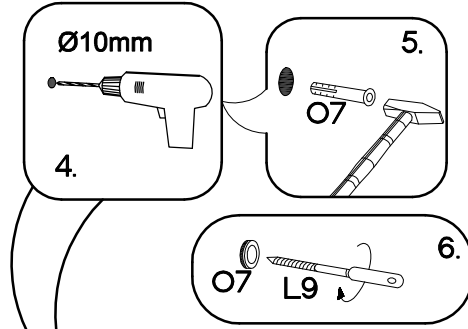
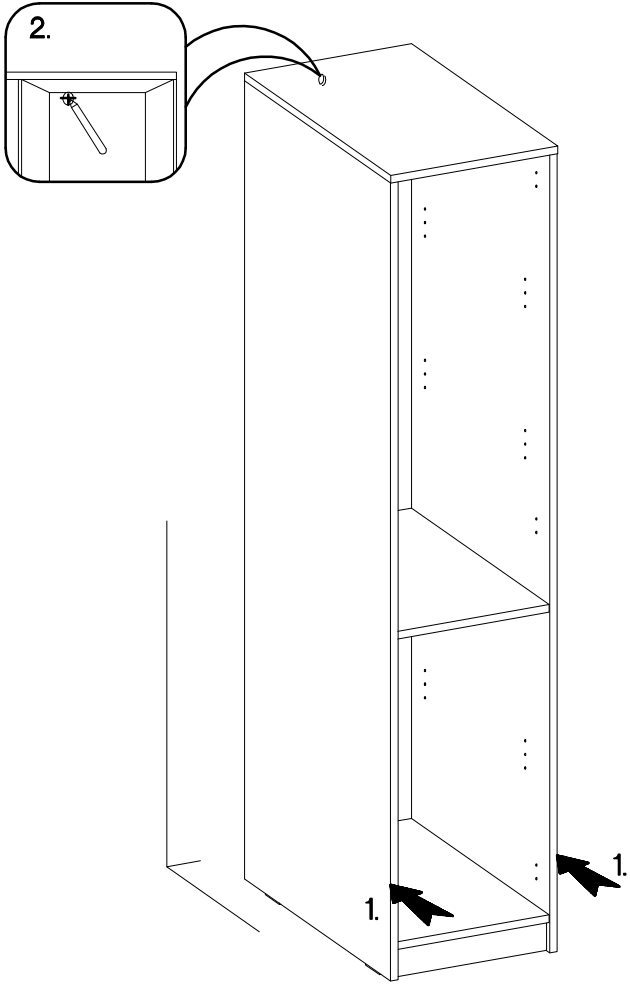

7

Ø10x50mm 		Ø3.5x13mm 
O7	L9	P5
1	1	1



 ±5/16mm J3	 ±20 E11
12	8

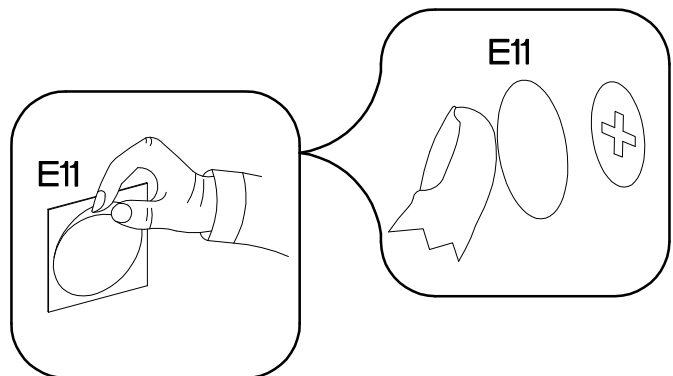
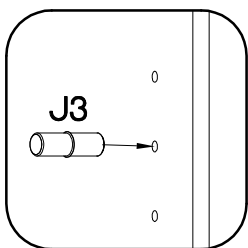
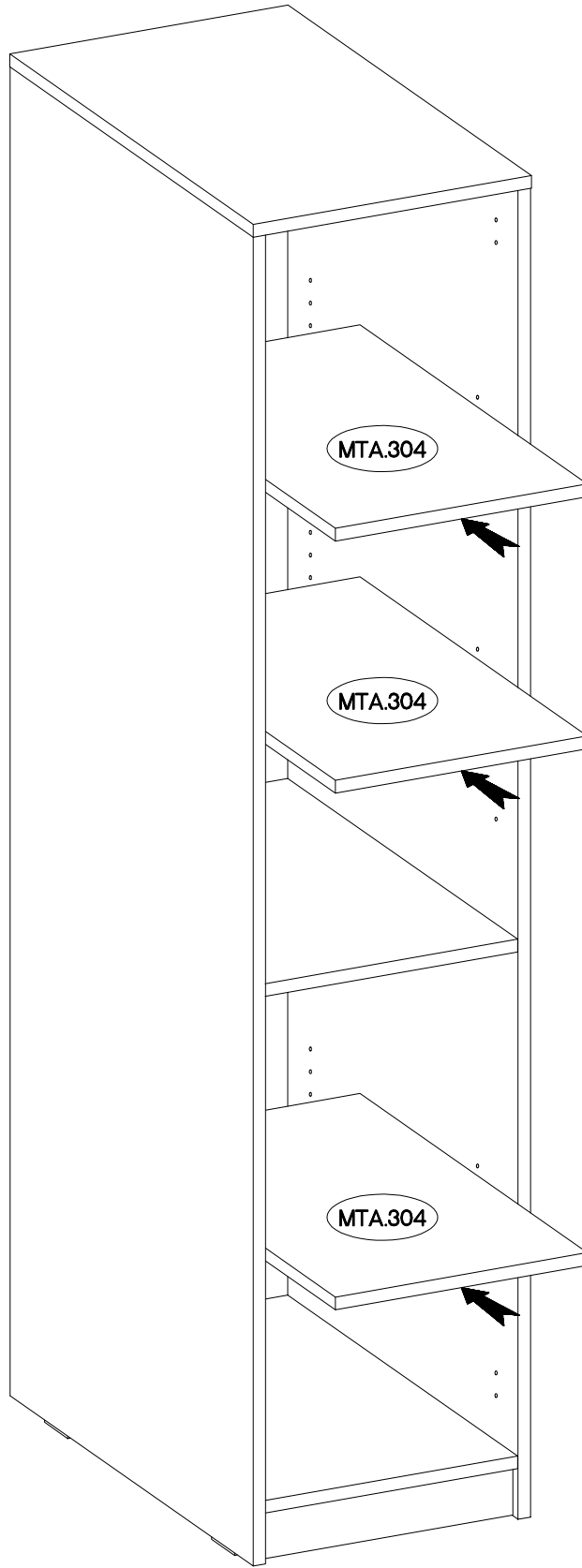

9

OPTION

