

VEGAS 36

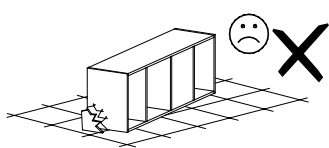

Narzędzia potrzebne do montażu

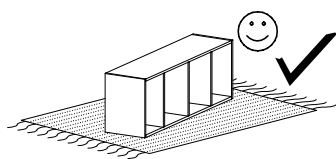
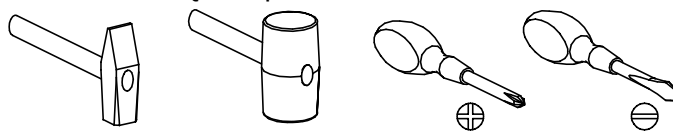

UWAGA !!!

MONTOWANIE USZKODZONYCH
ELEMENTÓW POWODUJE UTRATĘ
GWARANCJI

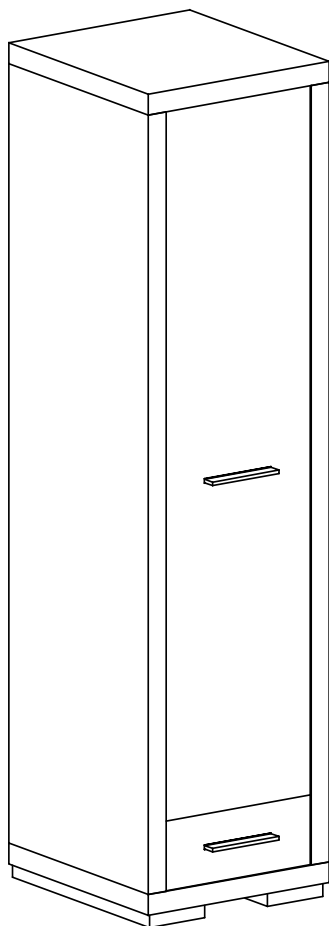

Nr	D[mm]	S[mm]	G[mm]	Ilość
1	492	542	48	1
2	492	542	48	1
3	522	458	16	1
4	1793	540	48	1
5	1793	540	48	1
6	388	1590	16	1
7	1820	482	2,5	1
8	388	190	16	1
9	500	165	16	1
10	337	165	16	1
11	500	165	16	1
12	368	505	2,5	1

W przypadku reklamacji proszę podać numer pakowacza znajdujący się na kartonie.

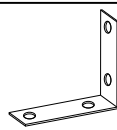

Y - 2 St.

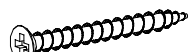

R - 6 St.
4x60 mm

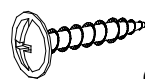

Q - 4 St.
3,5x16 mm

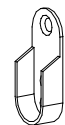

A - 2 St.

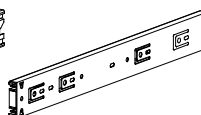
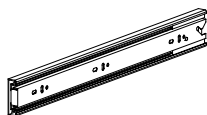

T - 1 Kpl.

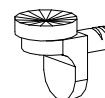

P - 1 St.

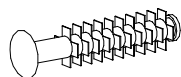

F - 4 St.



N - 4 St.
4x30 mm



U - 2 St.



G - 10 St.
3,5x16 mm



L - 16 St.



O - 1 St.



M - 14 St.
3x30 mm

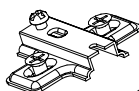

C - 3 St.

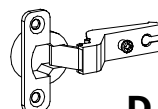

D - 3 St.



S - 1 St.



E - 50 St.



B - 20 St.

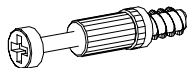

K - 16 St.



Z - 1 St.



J - 8 St.
5x13 mm

I

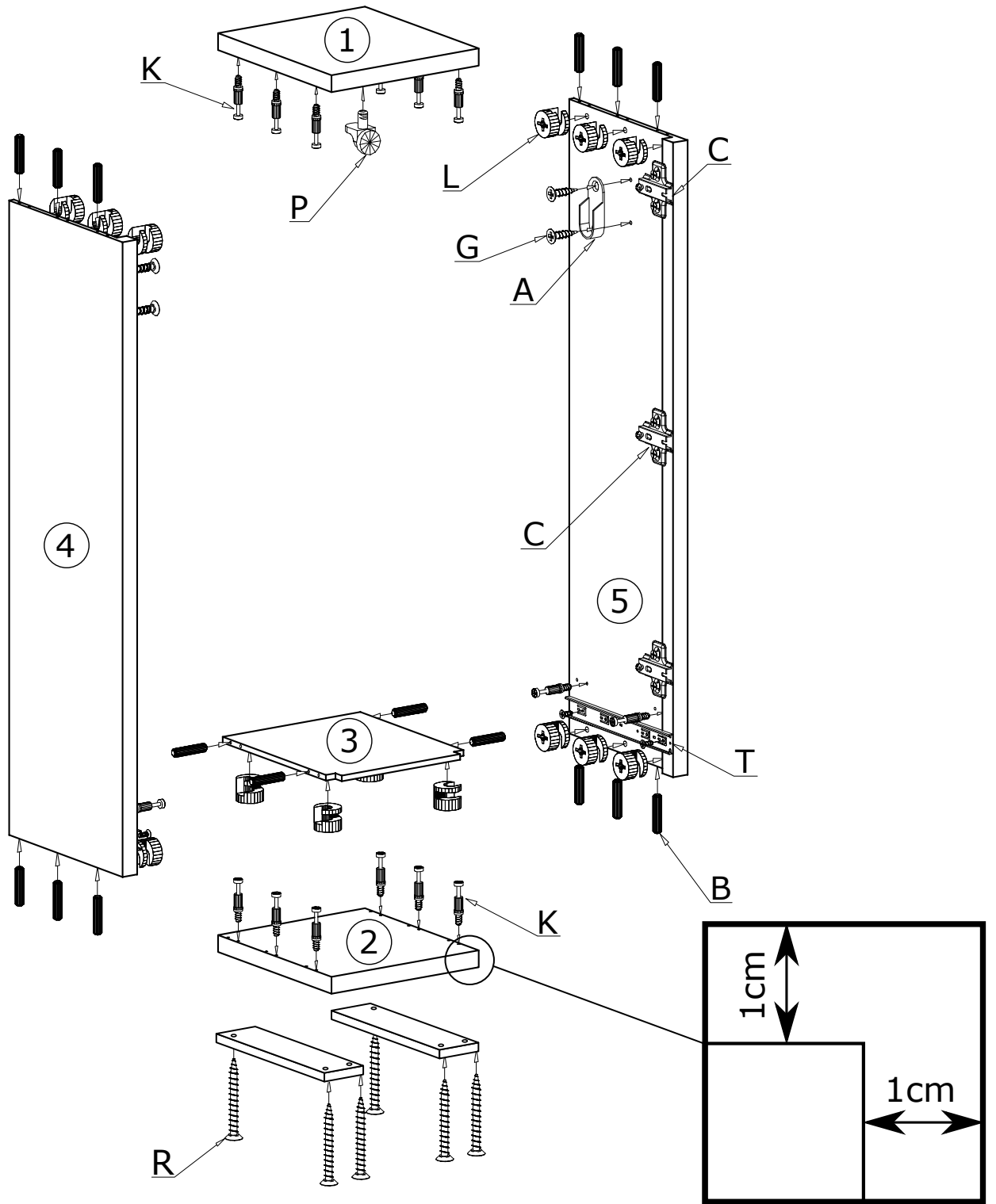

II

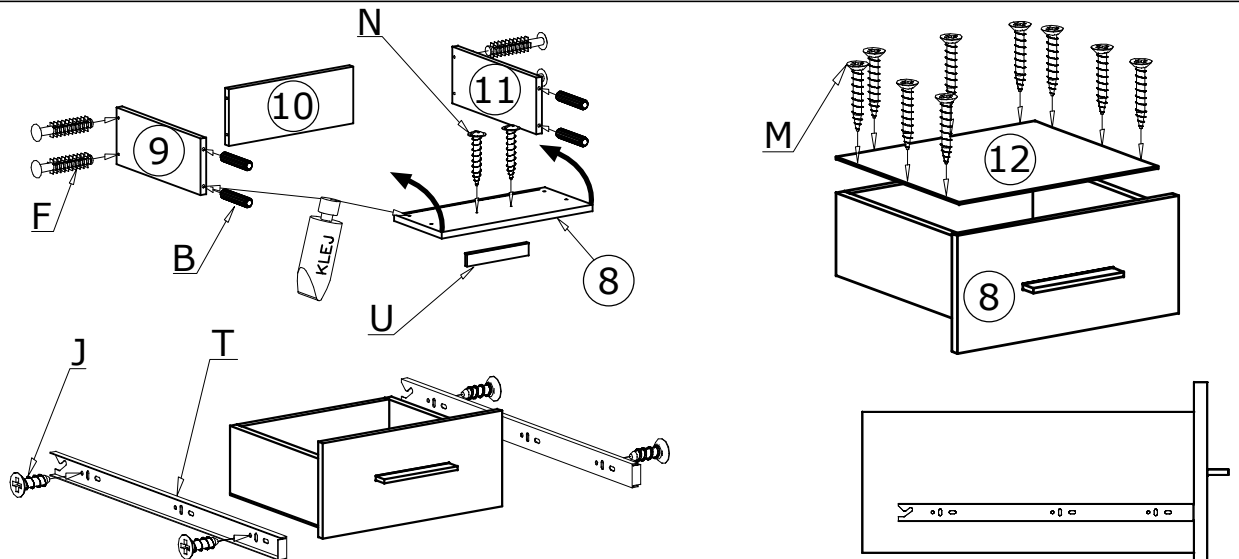

III

50X

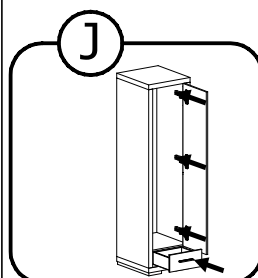
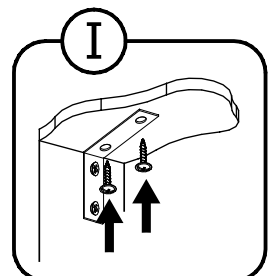
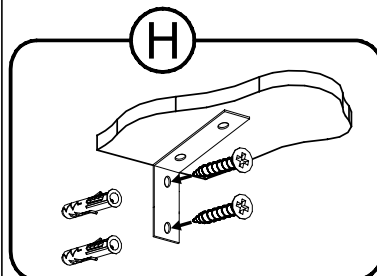
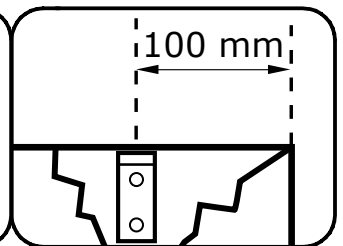
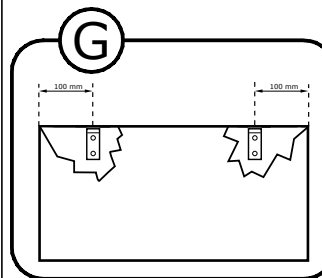
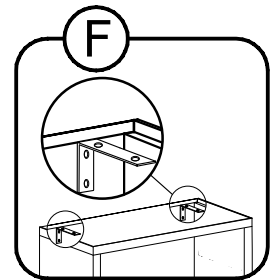
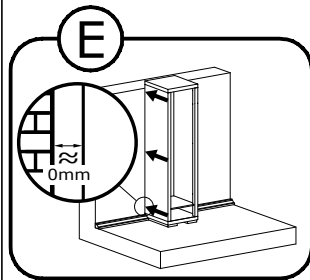
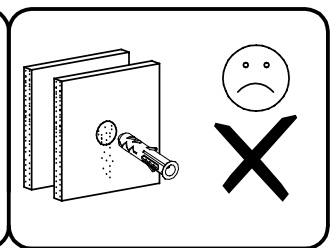
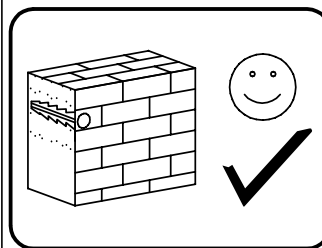
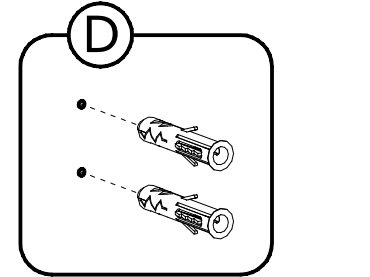
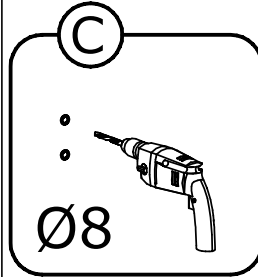
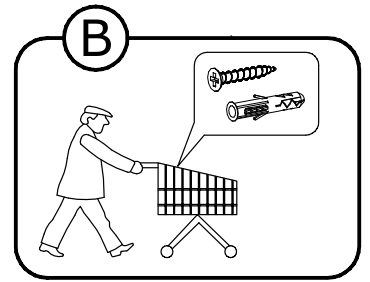
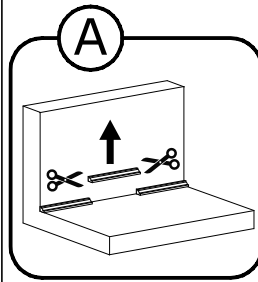
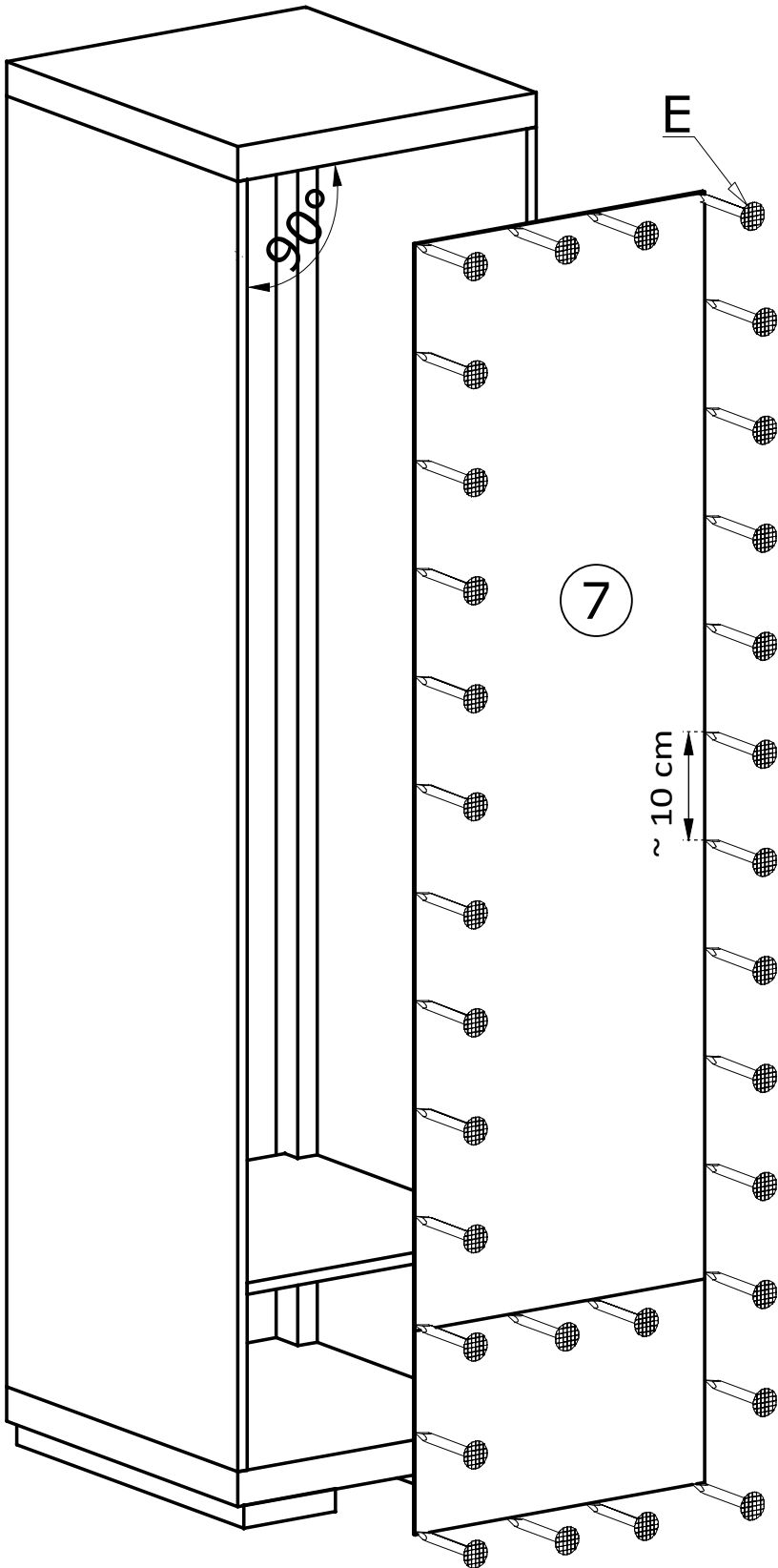

IV

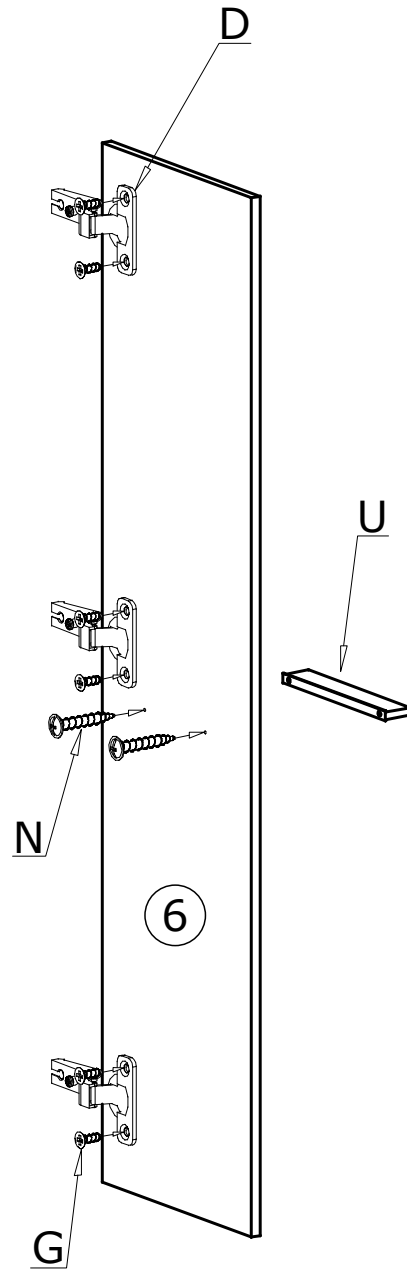
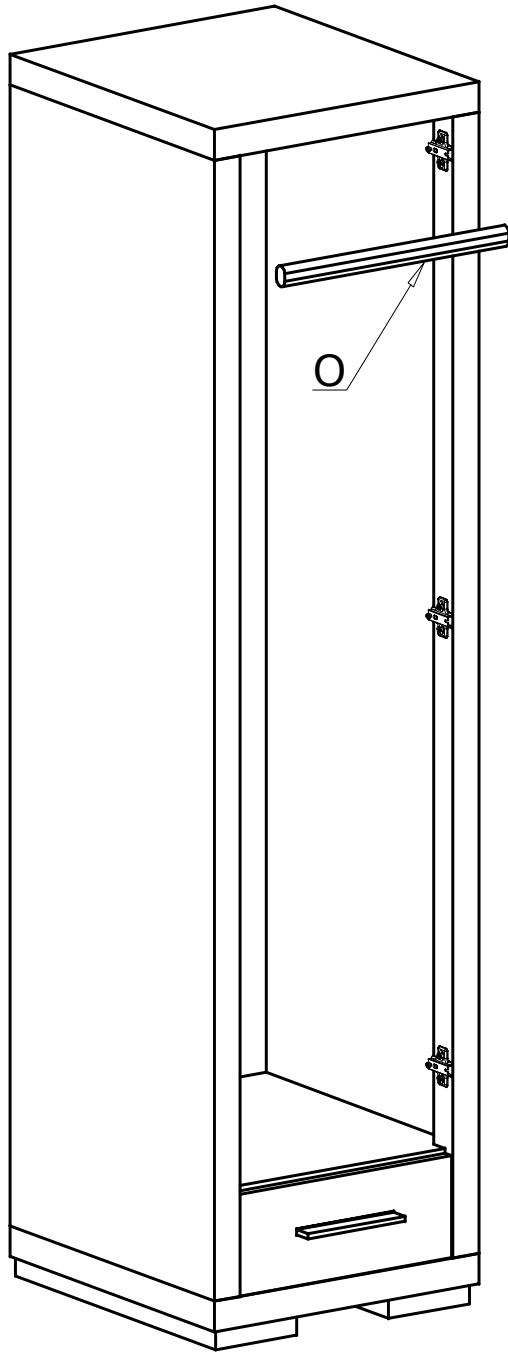

MONTAŻ/DEMONTAŻ PROWADNIC

1



2

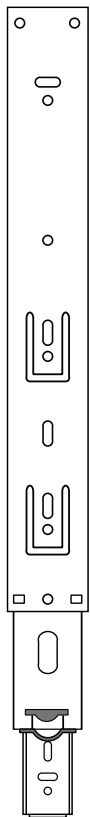

3

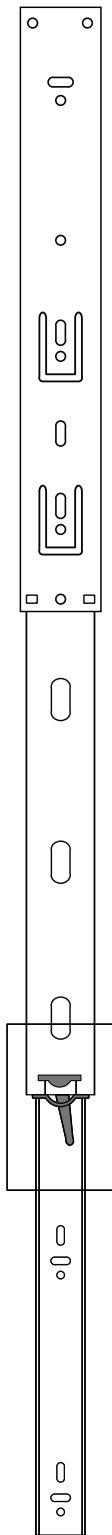

4

