

# TADEUSZ 16

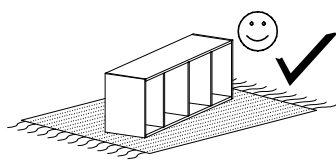

Narzędzia potrzebne do montażu



## UWAGA !!!

MONTOWANIE USZKODZONYCH  
ELEMENTÓW POWODUJE UTRATĘ  
GWARANCJI

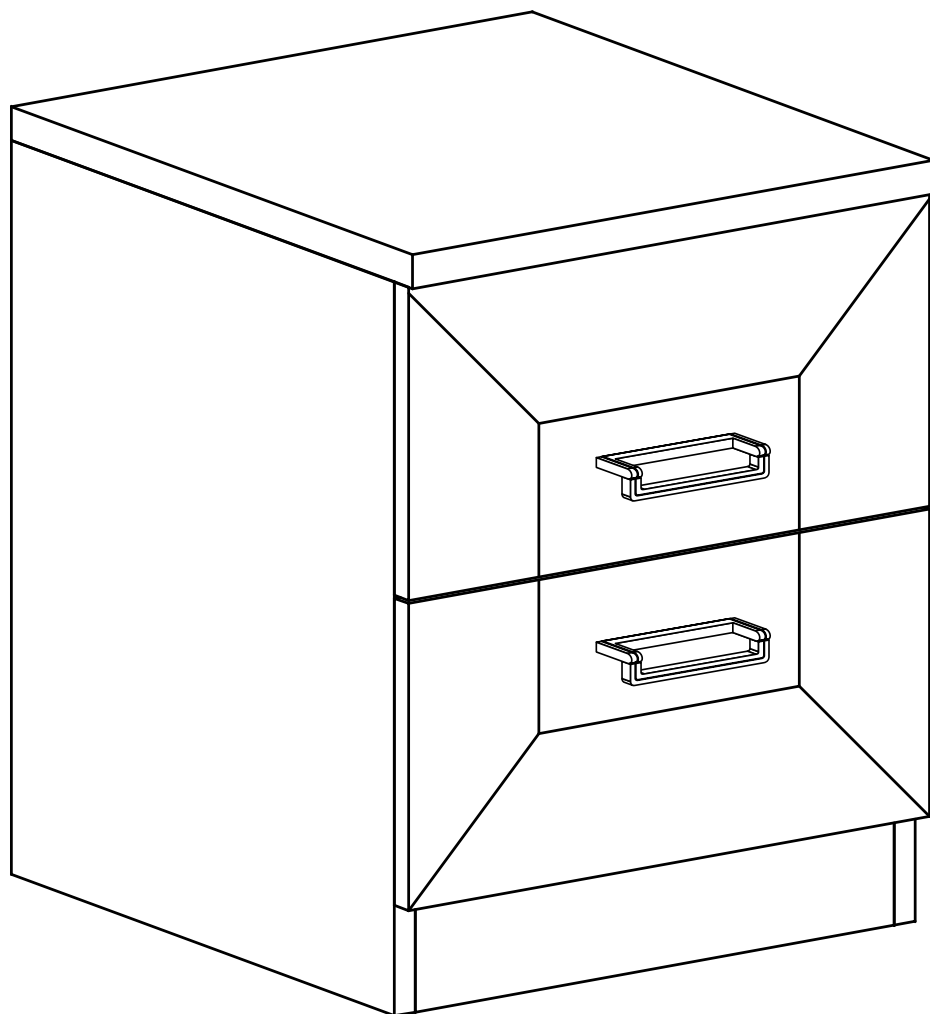

Nr	D[mm]	S[mm]	G[mm]	Ilość
1	440	400	32	1
2	405	352	16	1
3	475	405	16	1
4	475	405	16	1
5	352	80	16	1
6	420	380	2,5	1
7	296	150	16	2
8	400	150	16	2
9	400	150	16	2
10	382	190	16	2
11	405	323	2,5	2

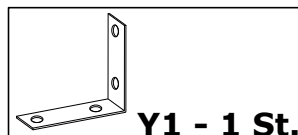

**Y1 - 1 St.**

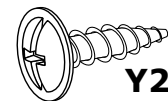

**Y2 - 2 St.**  
3,5x16 mm



**X2 - 4 St.**

W przypadku reklamacji proszę podać numer pakowacza znajdujący się na kartonie.

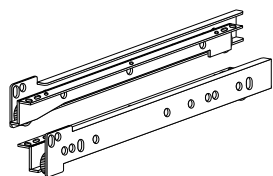

**T - 2 Kpl.**

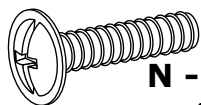

**N - 4 St.**  
4x22 mm



**U - 2 St.**

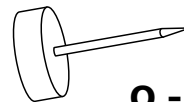

**Q - 4 St.**



**X1 - 8 St.**

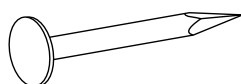

**E - 40 St.**

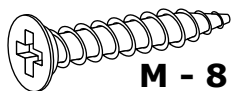

**M - 8 St.**  
4x25 mm

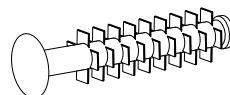

**F - 8 St.**

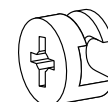

**L - 8 St.**

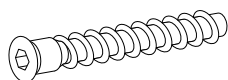

**R - 4 St.**



**B - 20 St.**

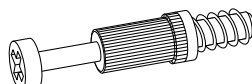

**K - 8 St.**



**Z - 1 St.**

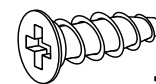

**J - 8 St.**  
5x13 mm

I

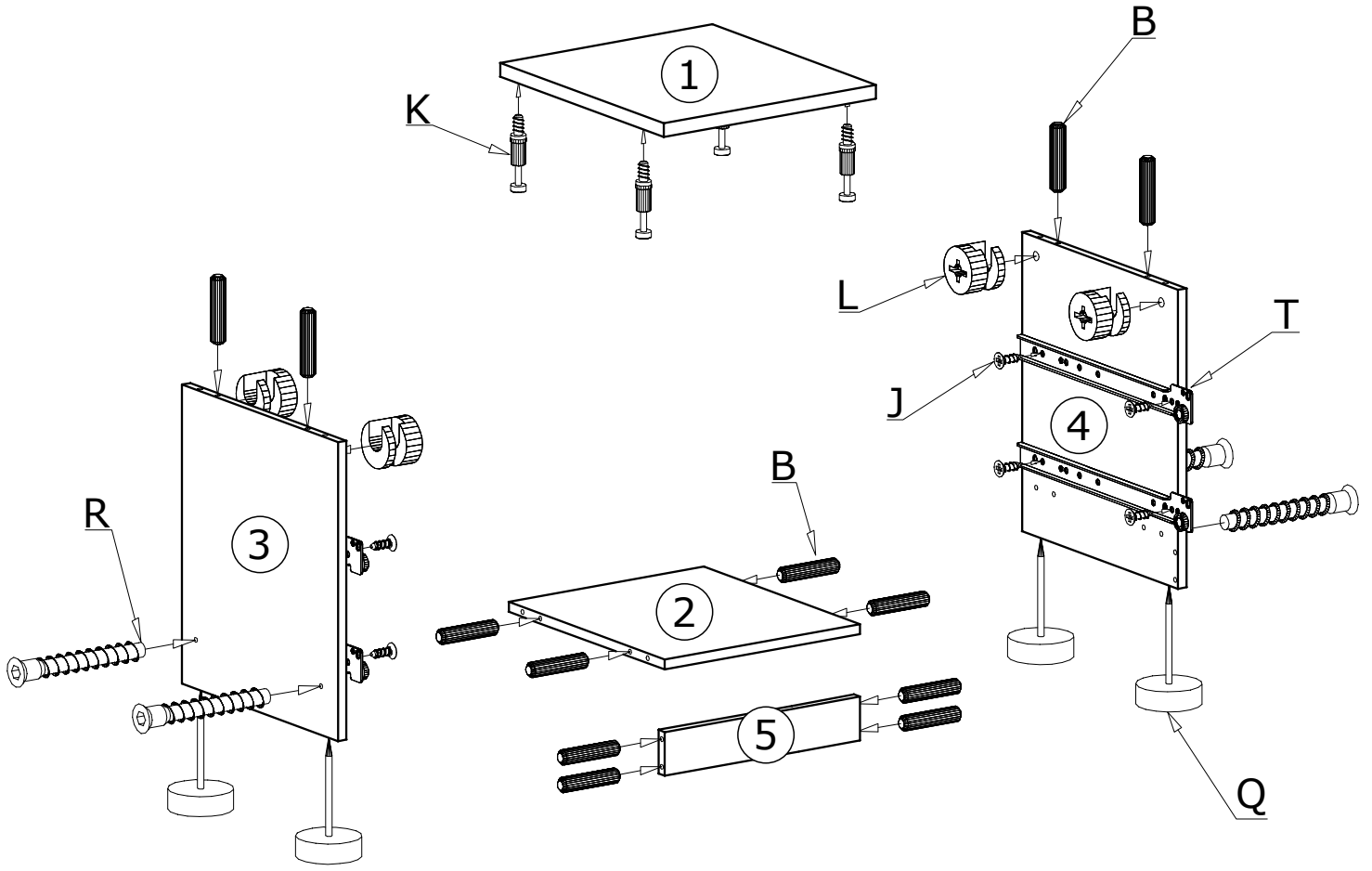

II

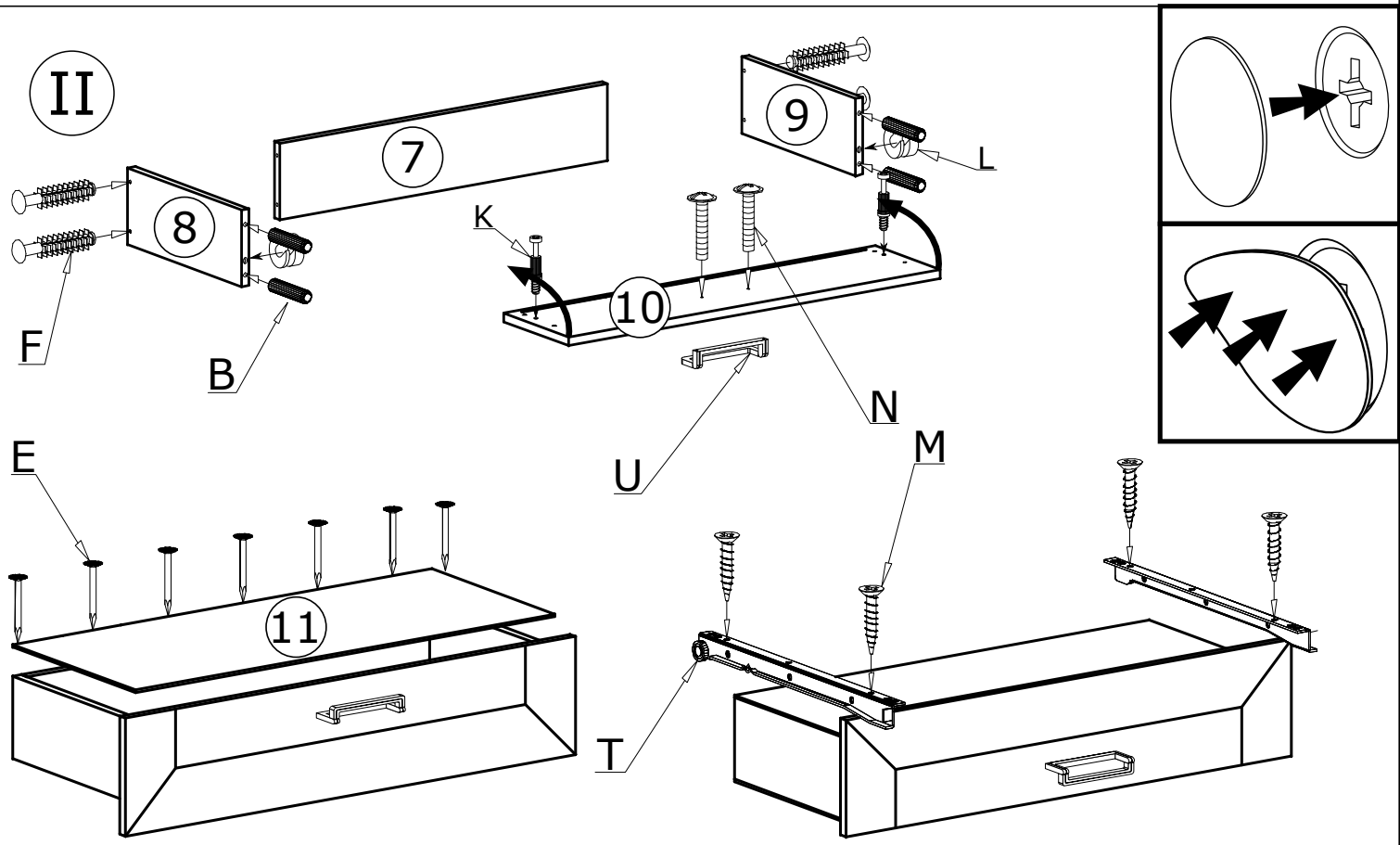

III

40X 

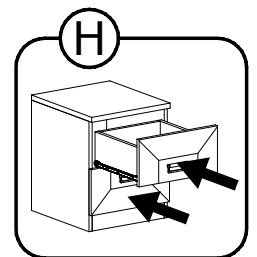
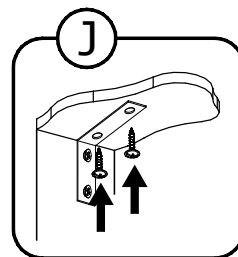
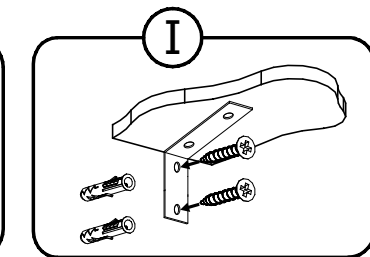
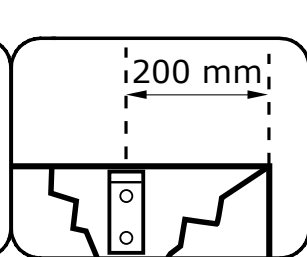
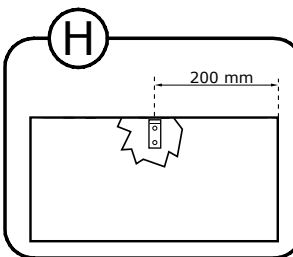
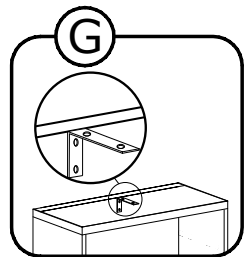
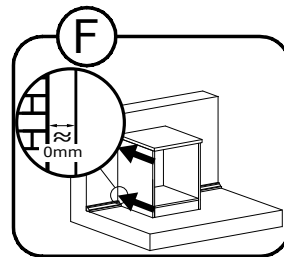
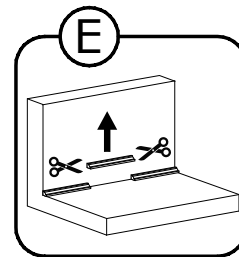
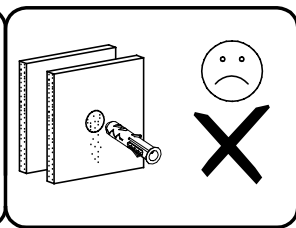
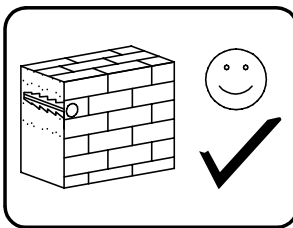
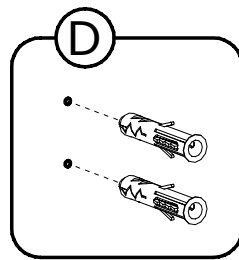
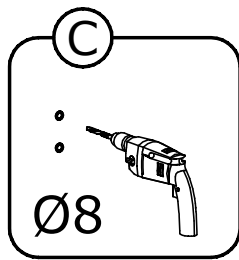
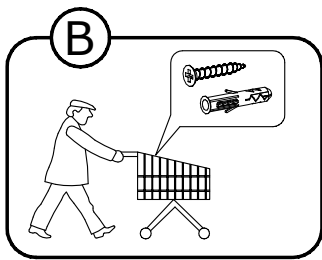
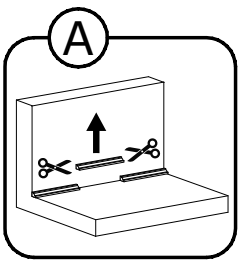
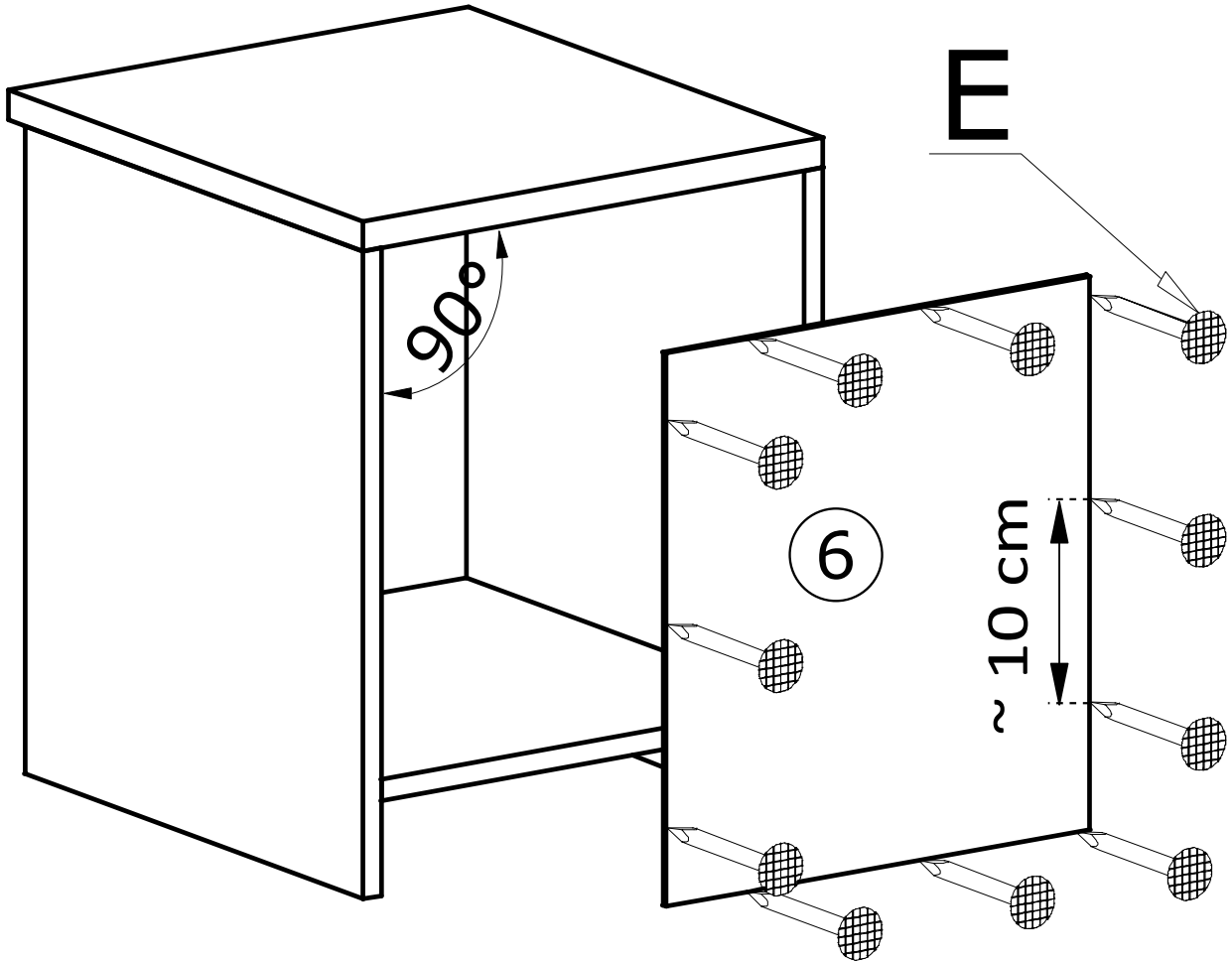

IV

