

# TADEUSZ 4



Narzędzia potrzebne do montażu



## UWAGA !!!

MONTOWANIE USZKODZONYCH  
ELEMENTÓW POWODUJE UTRATĘ  
GWARANCJI

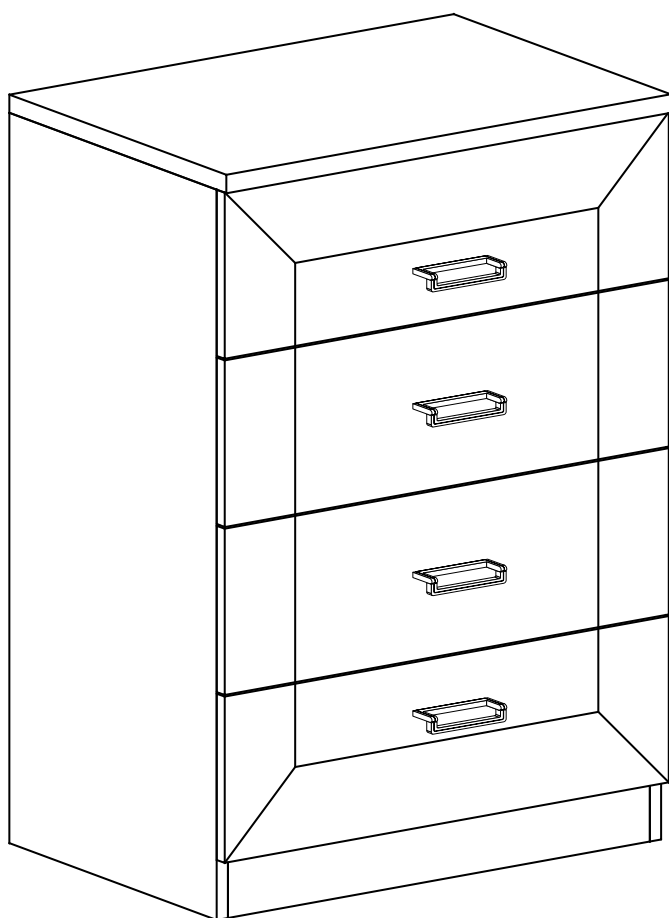

Nr	D[mm]	S[mm]	G[mm]	Ilość
1	635	440	32	1
2	585	405	16	1
3	865	405	16	1
4	865	405	16	1
5	585	80	16	1
6	612	808	2,5	1
7	527	150	16	4
8	405	150	16	4
9	405	150	16	4
10	603	190	16	4
11	555	405	2,5	4

W przypadku reklamacji proszę podać numer pakowacza znajdujący się na kartonie.

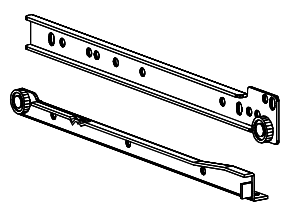

**T - 4 Kpl.**

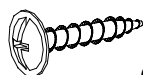

**Q - 4 St.**  
3,5x16 mm



**P - 16 St.**

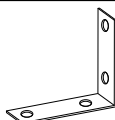

**Y - 2 St.**



**U - 4 St.**

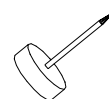

**Q - 4 St.**



**L - 12 St.**

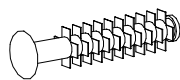

**F - 16 St.**

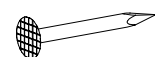

**E - 80 St.**

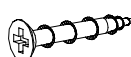

**M - 16 St.**  
3x30 mm

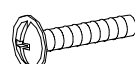

**N - 8 St.**  
4x25 mm



**S - 1 St.**

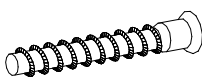

**R - 4 St.**



**B - 28 St.**

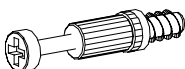

**K - 12 St.**

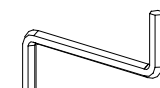

**Z - 1 St.**



**J - 16 St.**  
4x13 mm

I

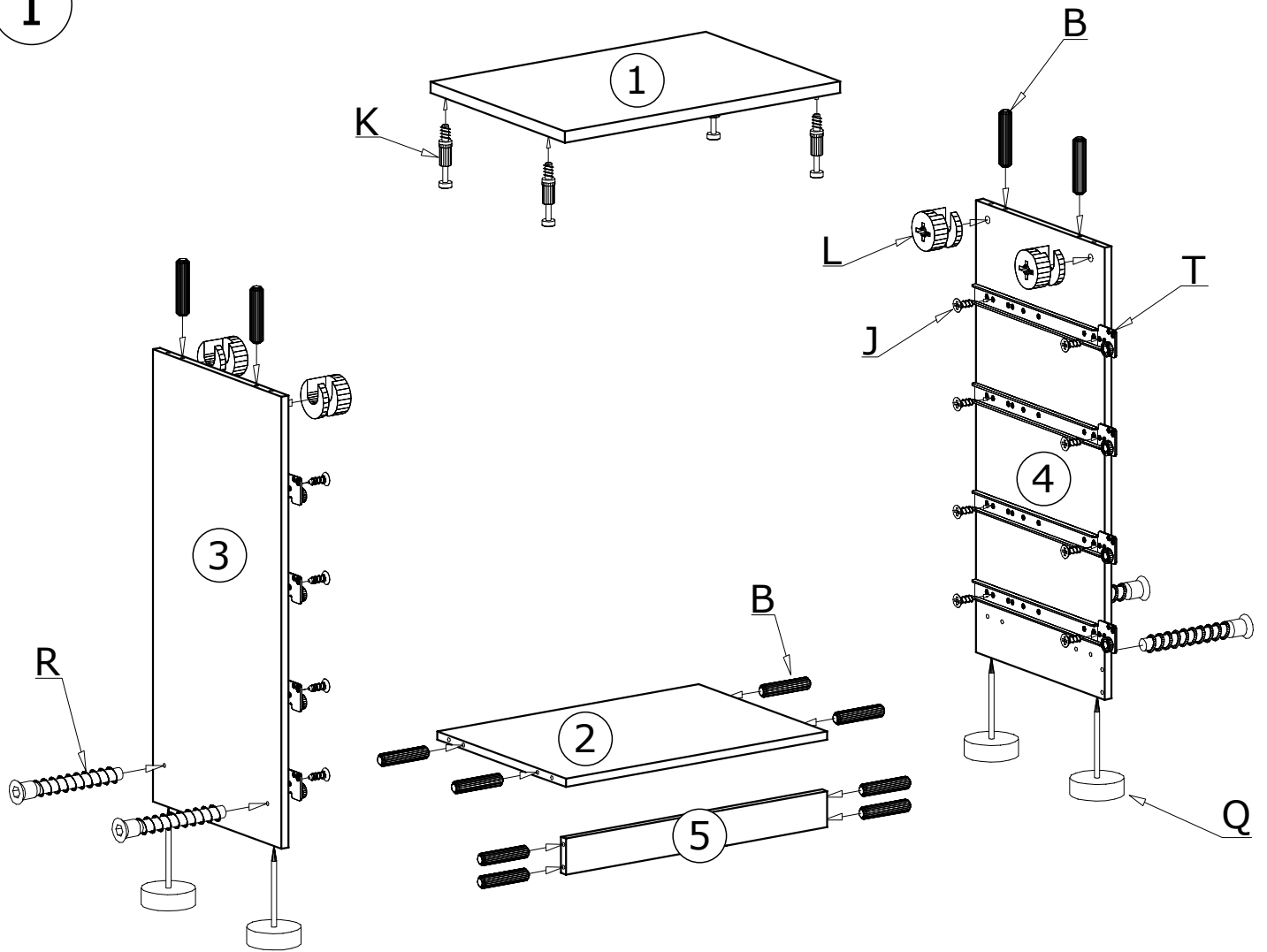

II

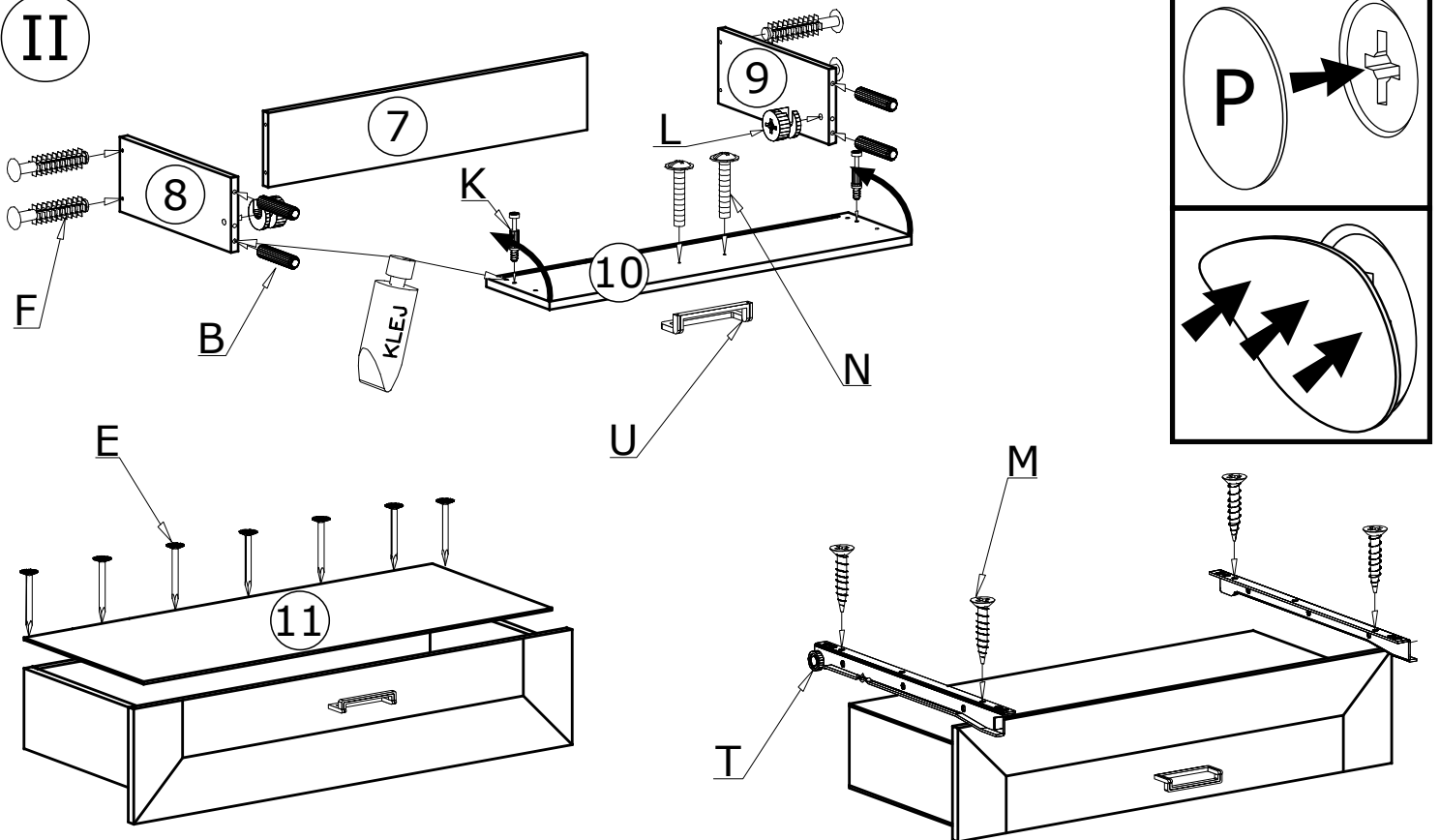

III

80X 

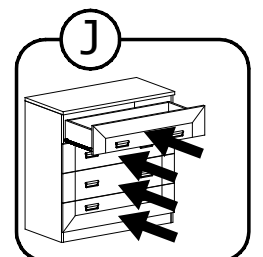
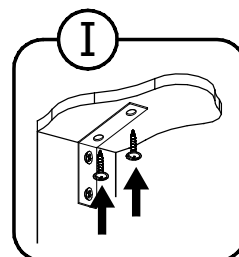
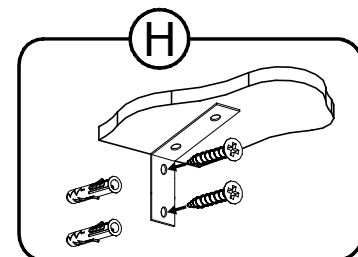
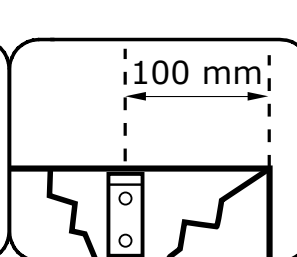
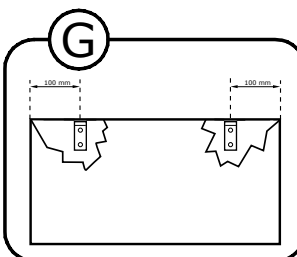
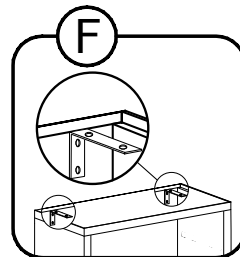
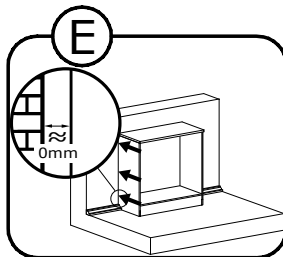
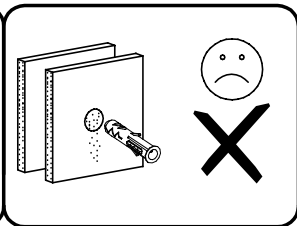
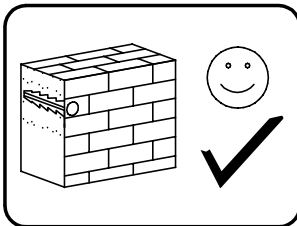
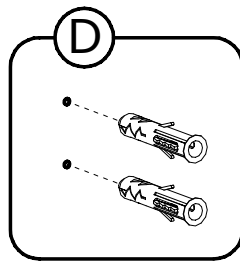
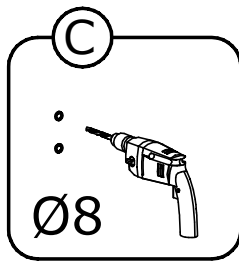
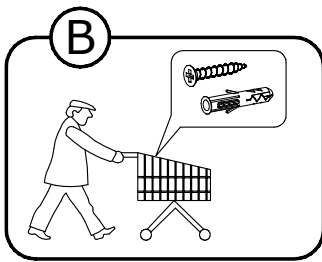
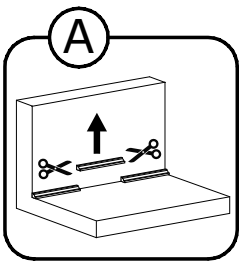
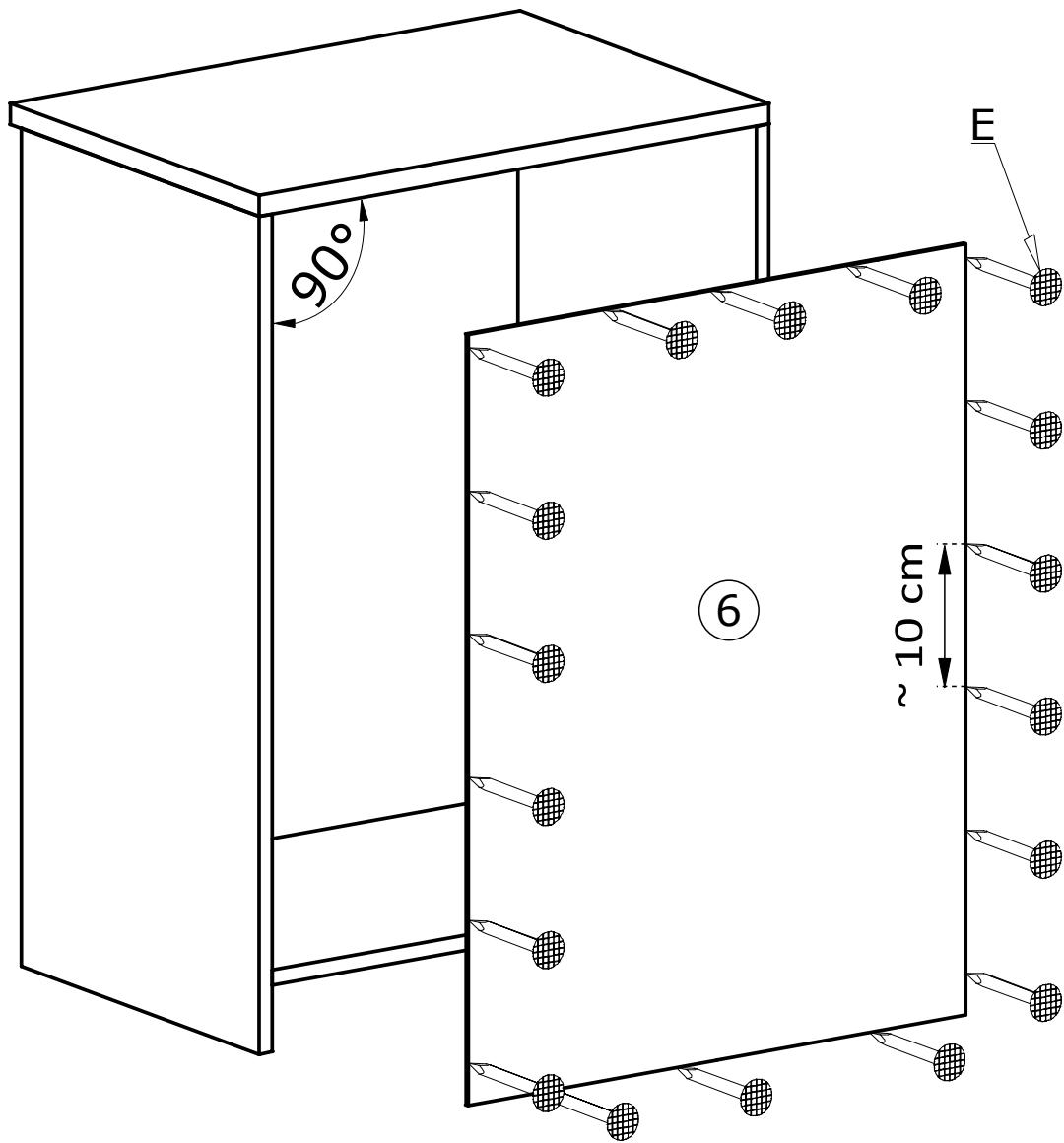

IV

