

# PARIS 9

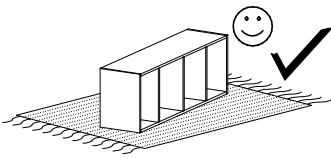

Narzędzia potrzebne do montażu

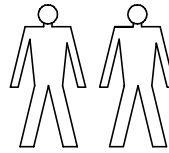
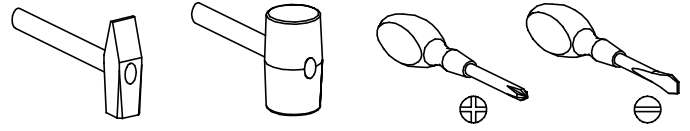

## UWAGA !!!

MONTOWANIE USZKODZONYCH  
ELEMENTÓW POWODUJE UTRATĘ  
GWARANCJI

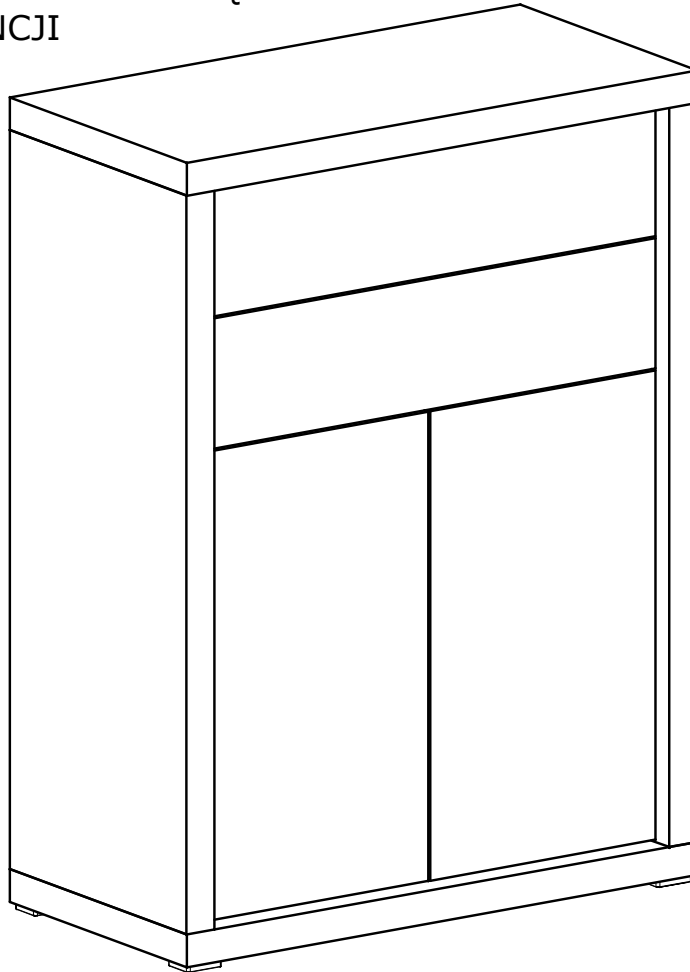

Nr	D[mm]	S[mm]	G[mm]	Ilość
1	882	436	48	1
2	882	436	48	1
3	1098	435	48	1
4	1098	435	48	1
5	848	388	16	1
6	780	190	16	2
7	350	165	16	2
8	350	165	16	2
9	726	165	16	2
10	756	355	2,5	2
11	870	392	2,5	1
12	700	388	16	1
13	700	388	16	1
14	870	754	2,5	1



**X1 - 12 St.**

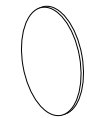

**X2 - 4 St.**

W przypadku reklamacji proszę podać numer pakowacza znajdujący się na kartonie.

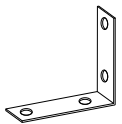

**Y - 2 St.**

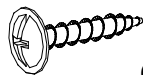

**Q - 4 St.**  
3,5x16 mm

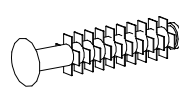

**P - 8 St.**



**R - 8 St.**  
3,5x25 mm



**Z - 1 St.**

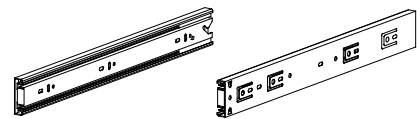

**T - 2 Kpl.**

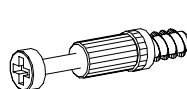

**K - 16 St.**

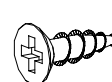

**G - 20 St.**  
3,5x16 mm



**L - 16 St.**

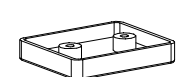

**A - 4 St.**



**N - 30 St.**  
3x30 mm

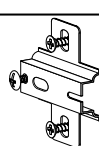

**C - 4 St.**

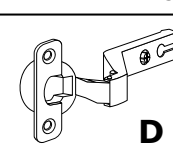

**D - 4 St.**



**J - 16 St.**  
5x13 mm

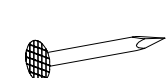

**E - 60 St.**

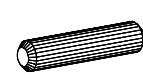

**B - 20 St.**

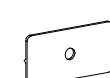

**S - 8 St.**

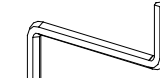

**Z - 1 St.**

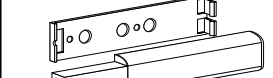

**F - 2 St.**

I

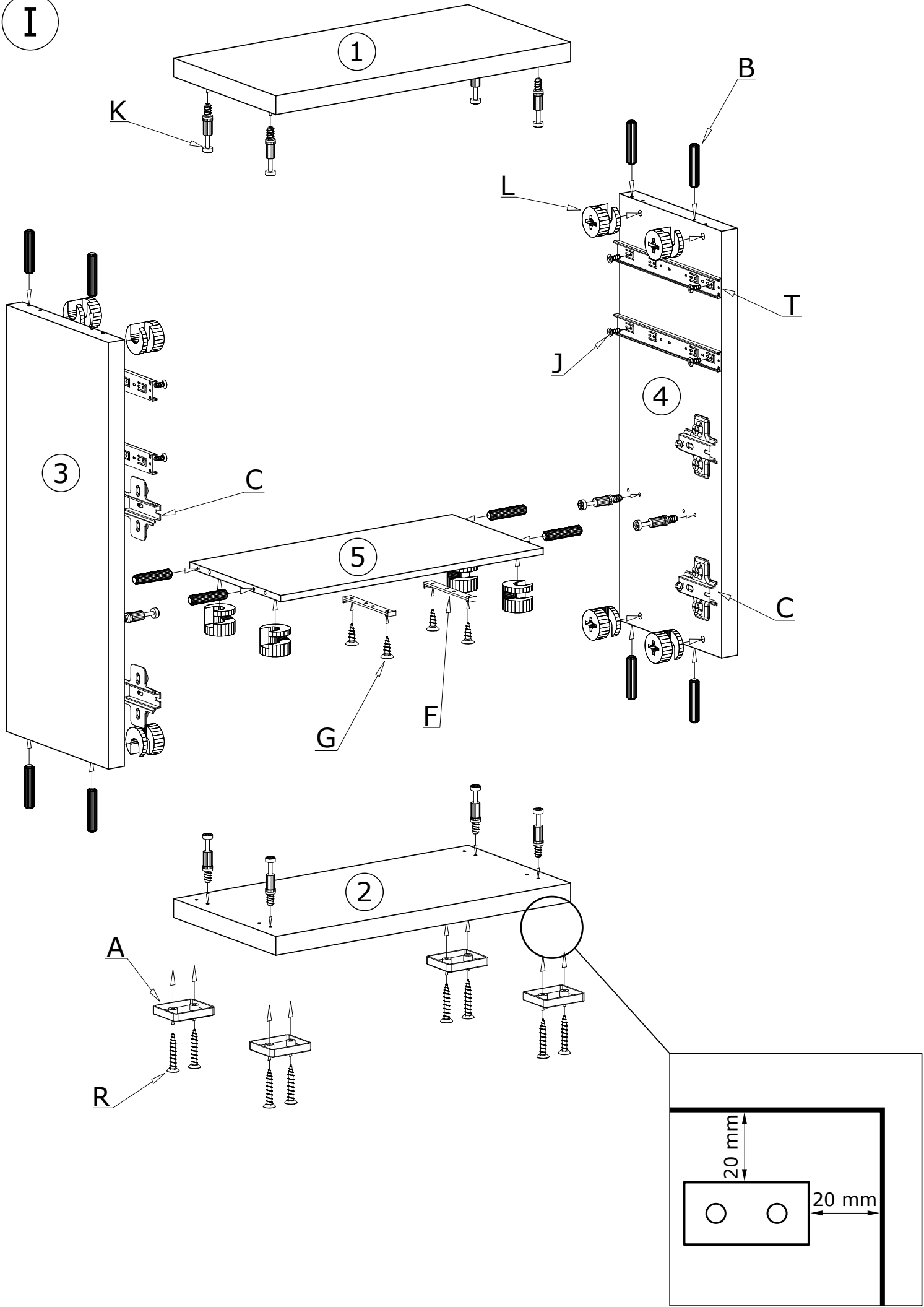

1

K

B

L

T

3

C

4

J

5

F

G

2

A

R

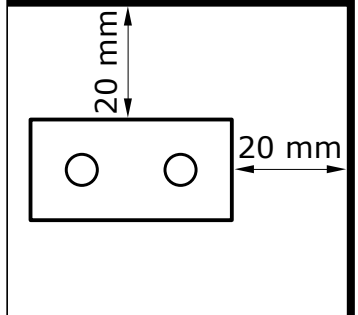

II

60X 

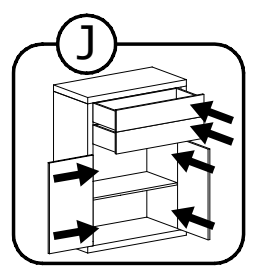
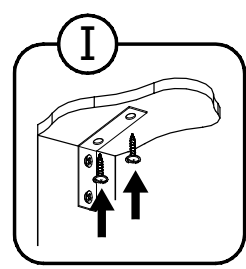
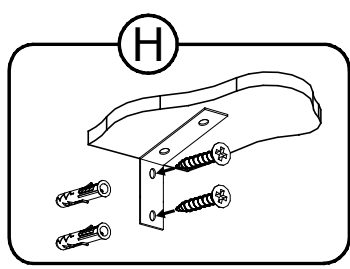
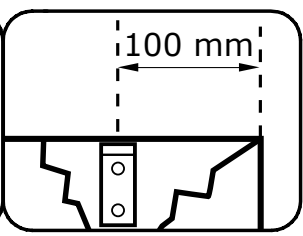
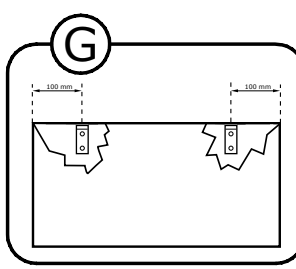
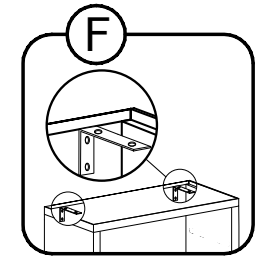
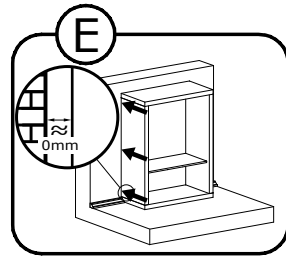
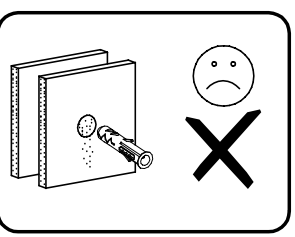
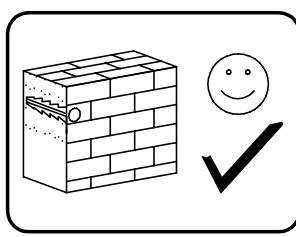
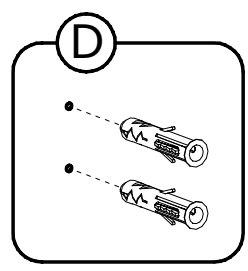
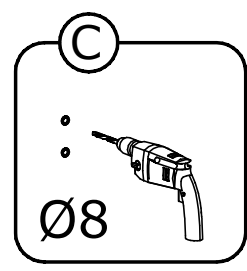
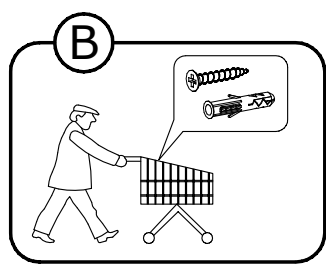
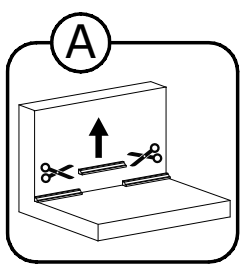
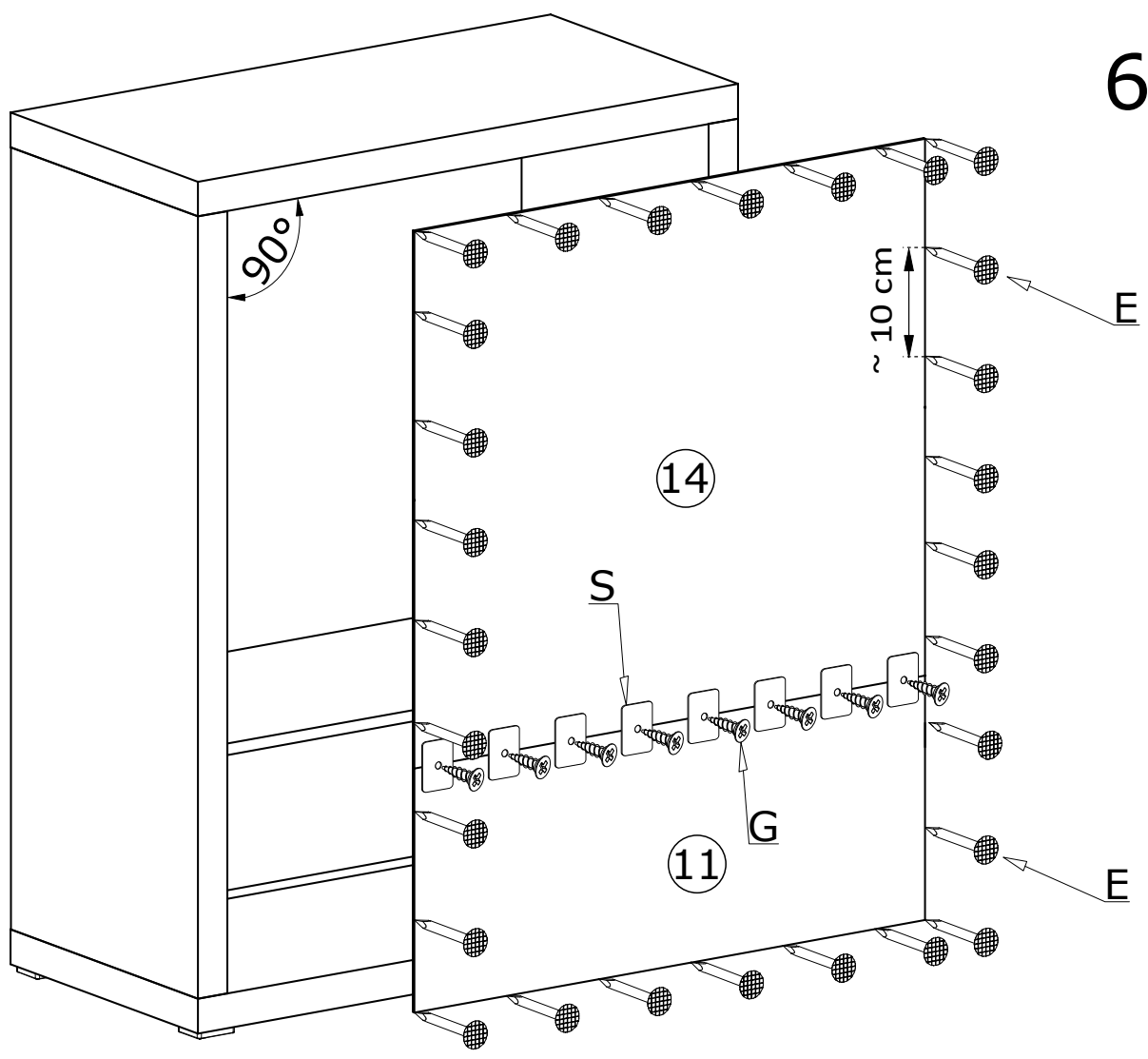

III

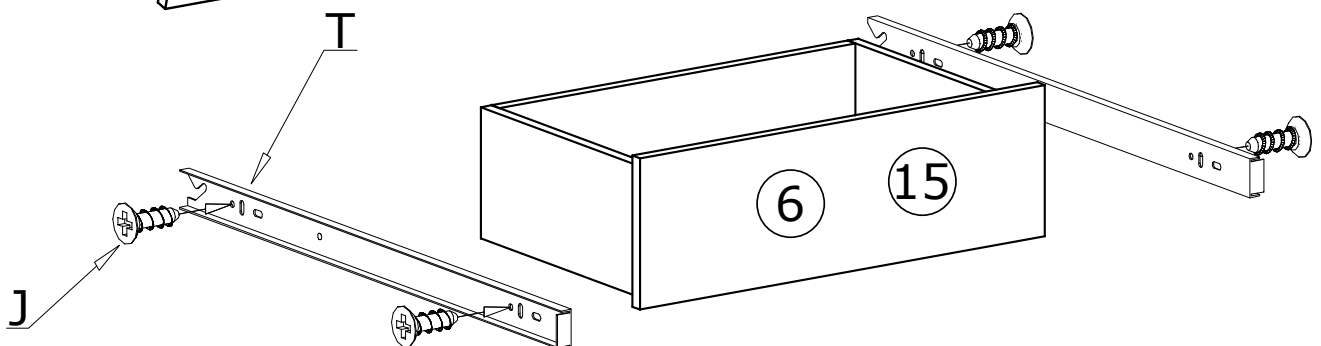
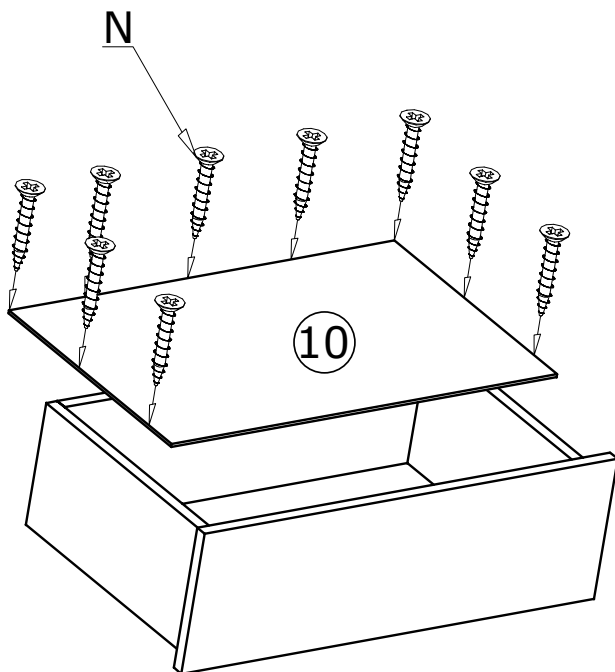
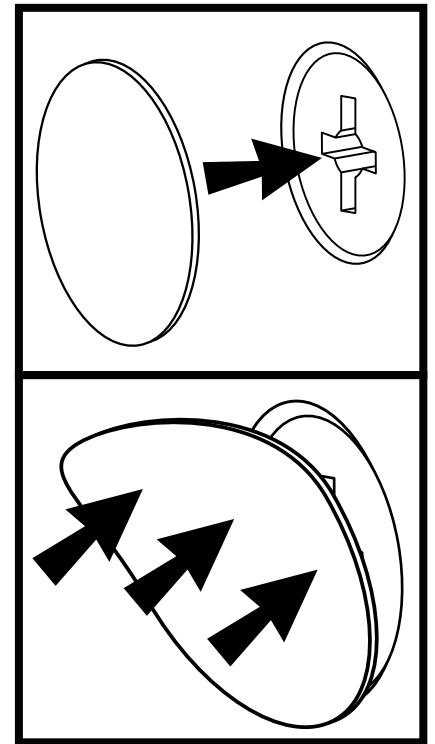
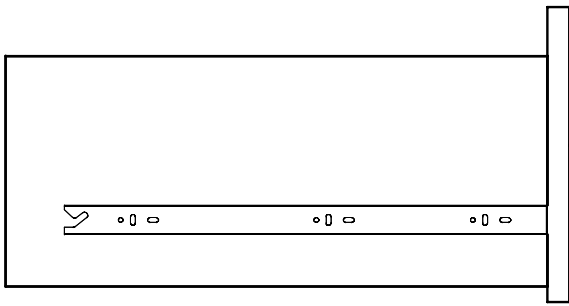
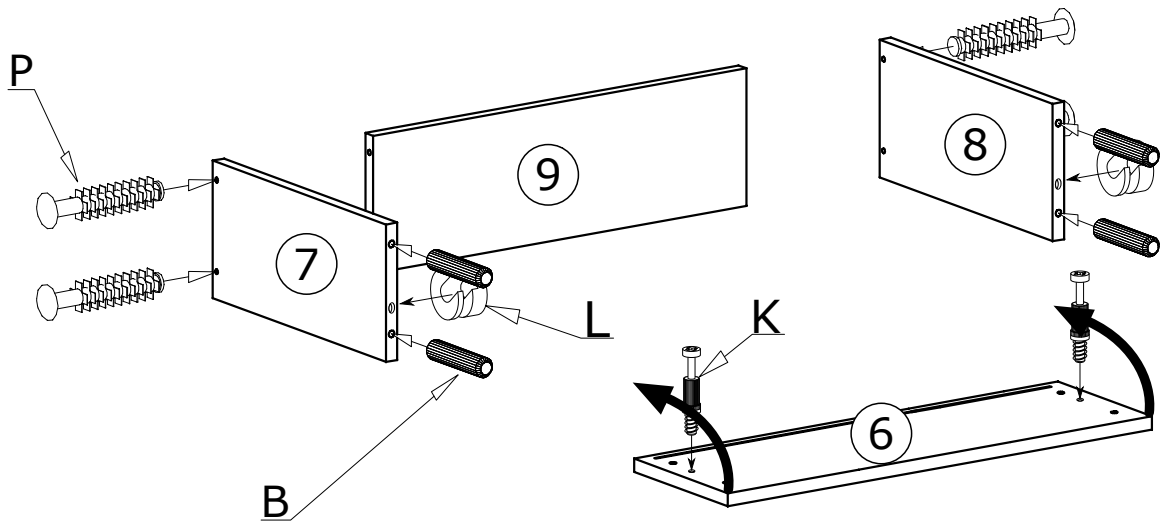

IV

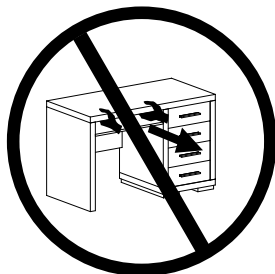
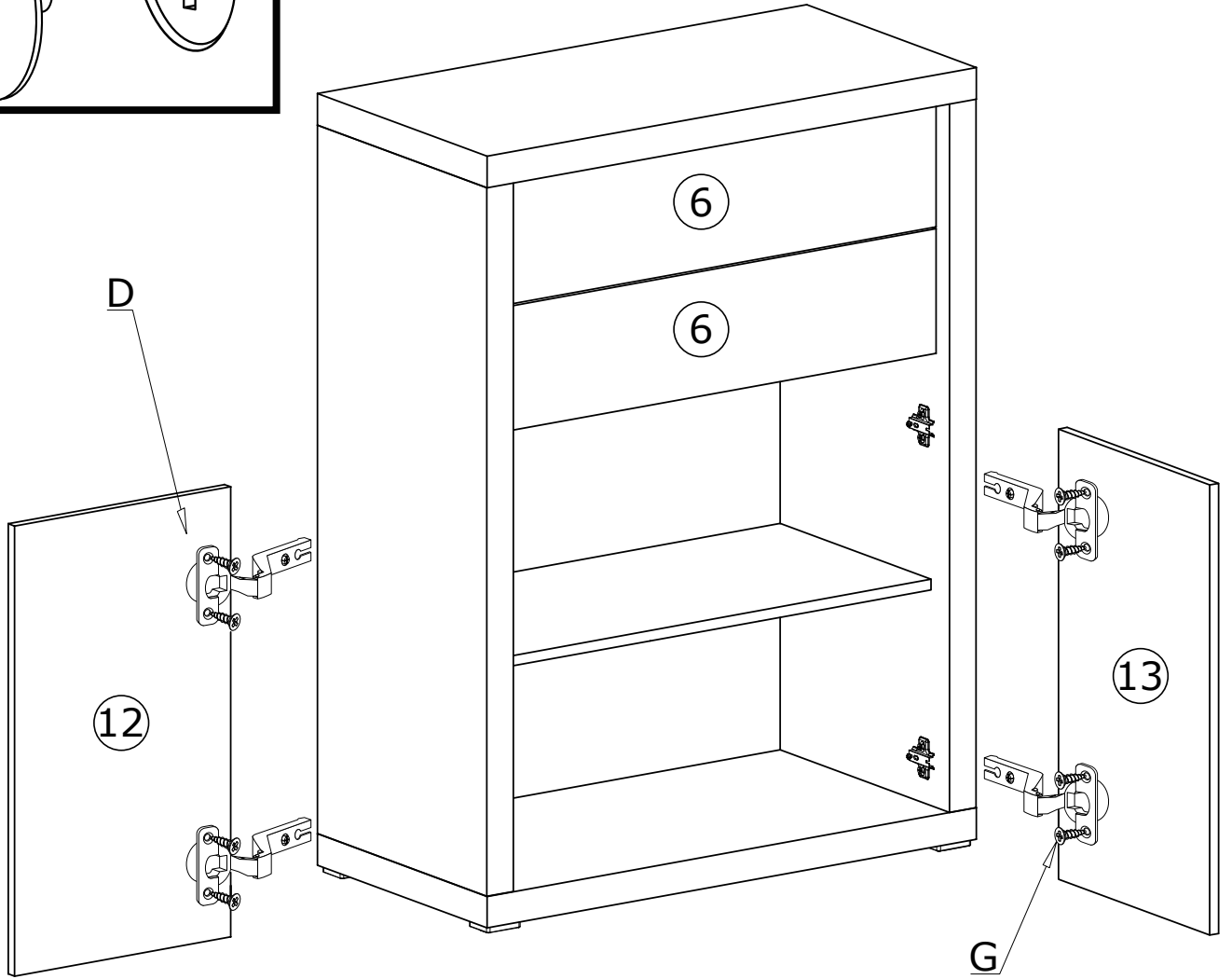
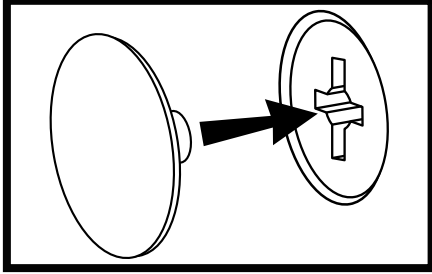
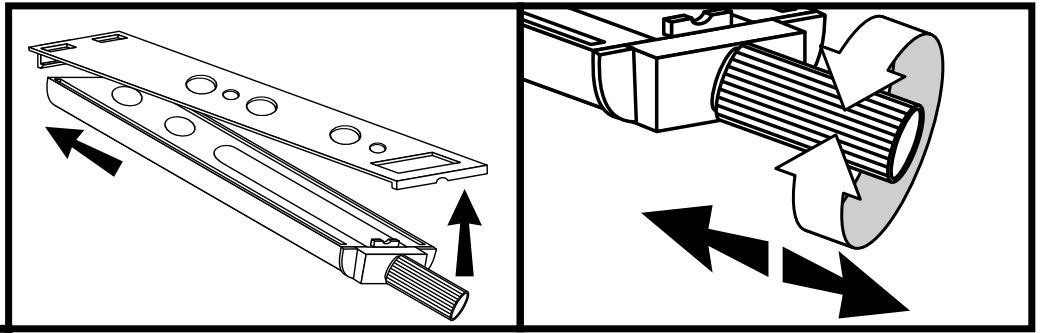

# MONTAŻ/DEMONTAŻ PROWADNIC

1

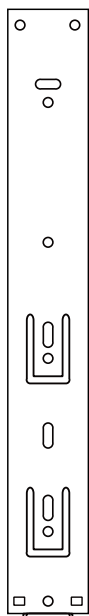

2

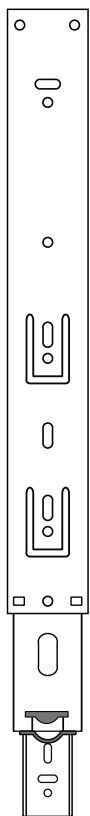

3

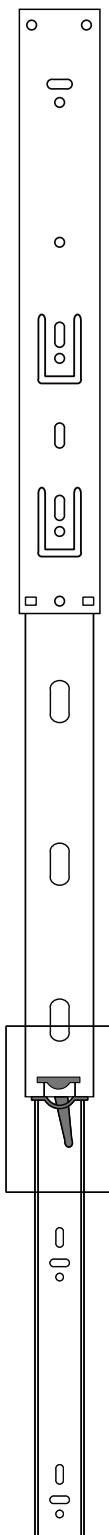

4

