

# PARIS 4

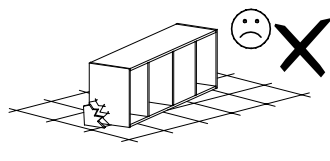

Narzędzia potrzebne do montażu

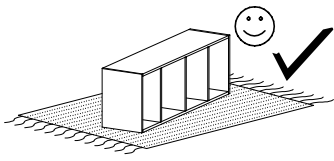
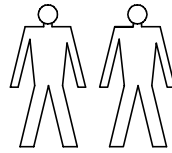
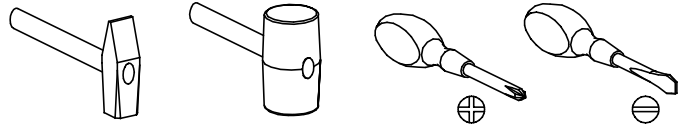

## UWAGA !!!

MONTOWANIE USZKODZONYCH  
ELEMENTÓW POWODUJE UTRATĘ  
GWARANCJI

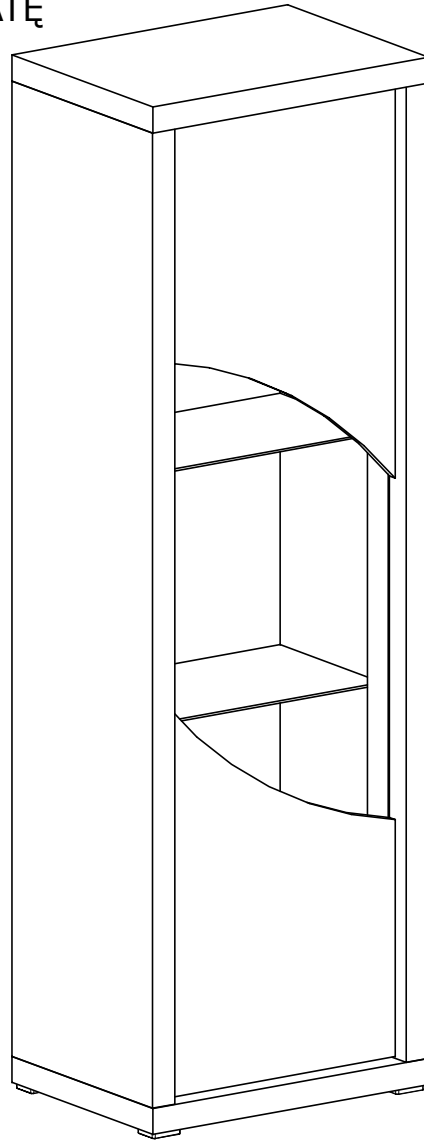

Nr	D[mm]	S[mm]	G[mm]	Ilość
1	602	436	48	1
2	602	436	48	1
3	503	370	16	2
4	1790	435	48	1
5	1790	435	48	1
6	1840	590	2,5	1
7	955	495	4	1
8	497	720	16	1
9	497	720	16	1
10	500	370	4	2

W przypadku reklamacji proszę podać numer pakowacza znajdujący się na kartonie.

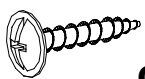

**Q - 4 St.**  
3,5x16 mm

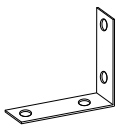

**Y - 2 St.**

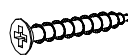

**N - 8 St.**  
3,5x25 mm

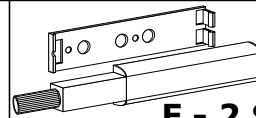

**F - 2 St.**



**G - 20 St.**  
3,5x16 mm

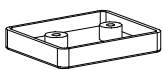

**A - 4 St.**

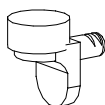

**S - 9 St.**

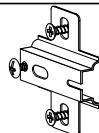

**C - 4 St.**

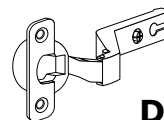

**D - 4 St.**

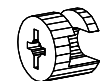

**L - 16 St.**



**E - 60 St.**



**B - 16 St.**

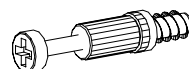

**K - 16 St.**

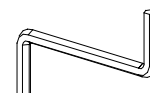

**Z - 1 St.**

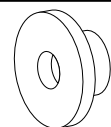

**R - 8 St.**

I

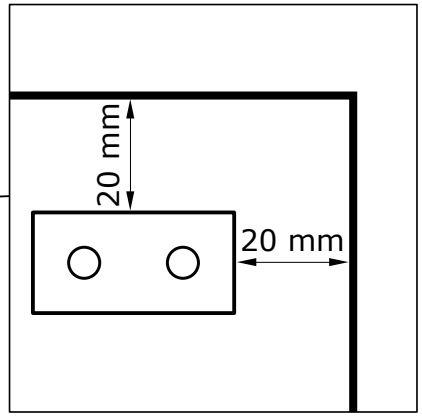
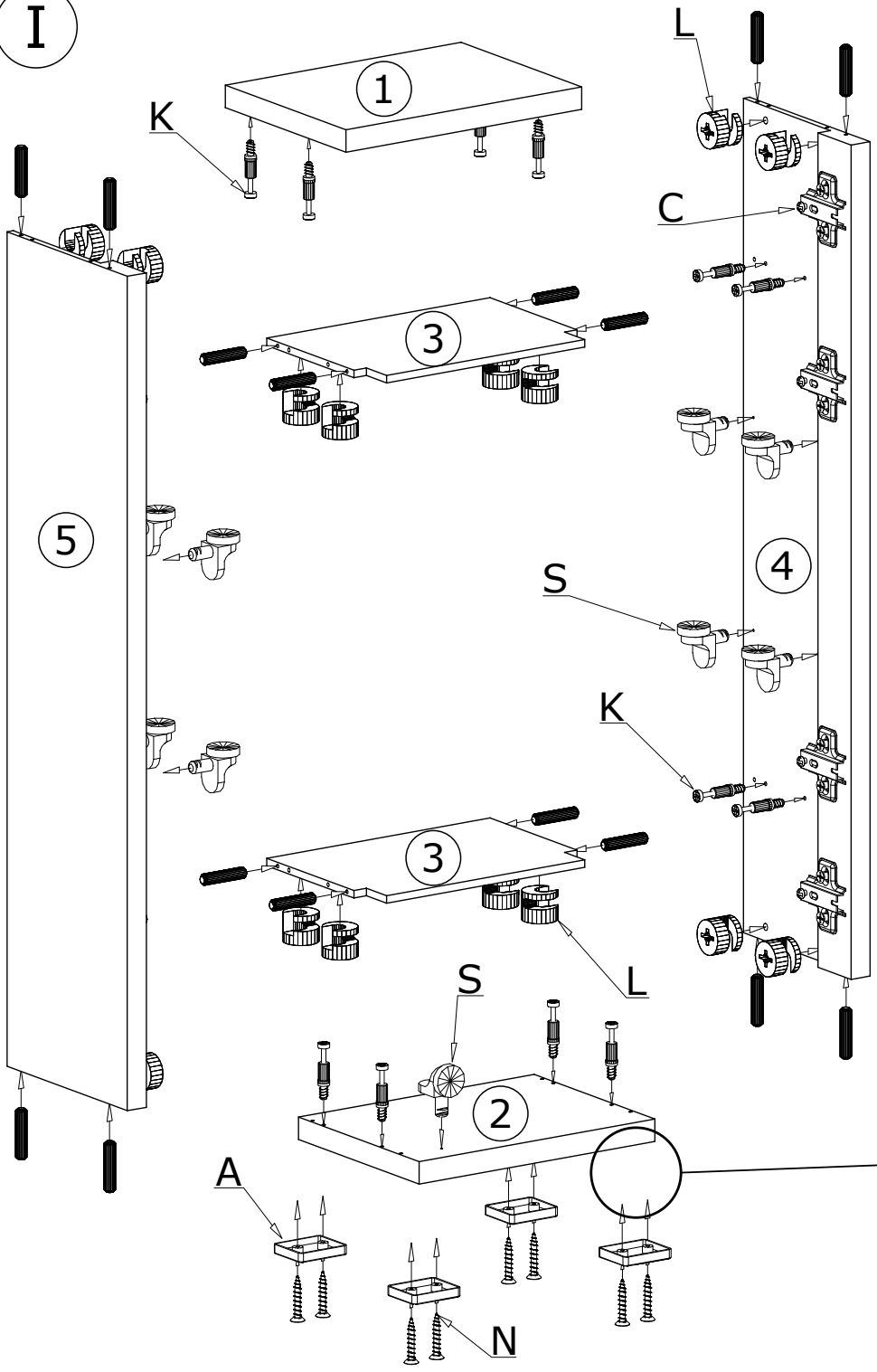

II

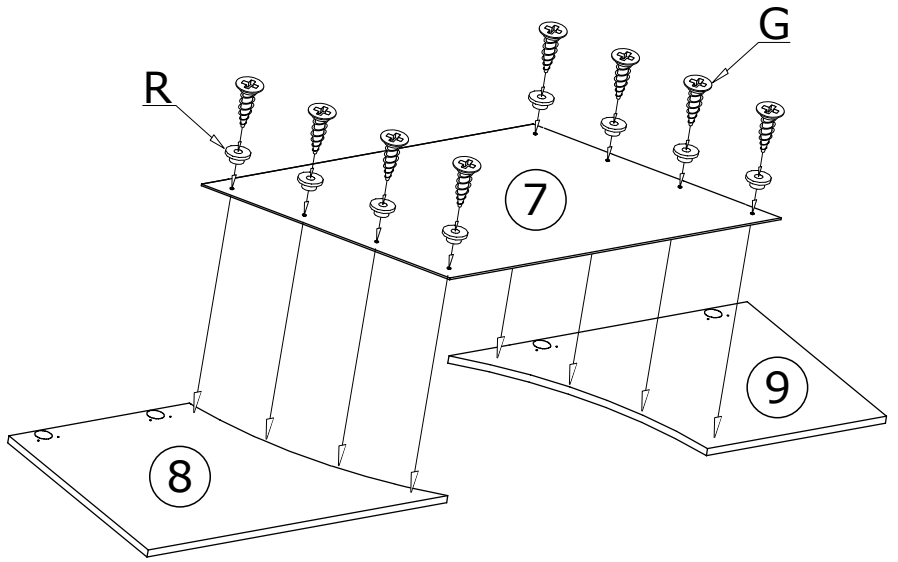
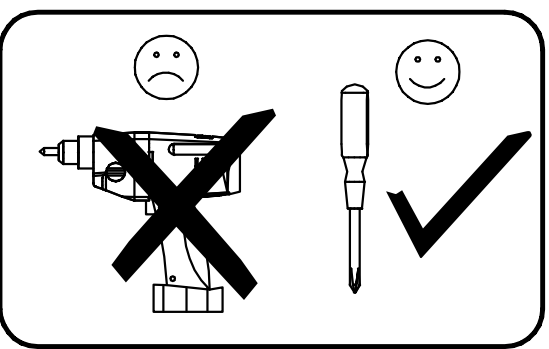

III

60X 

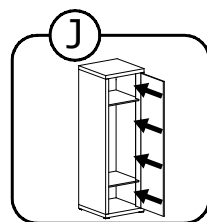
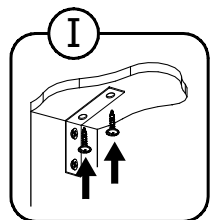
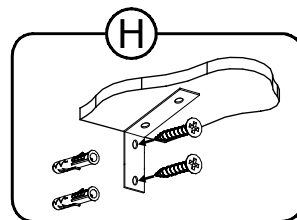
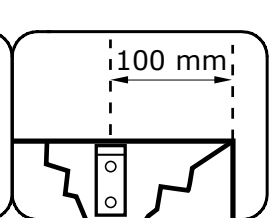
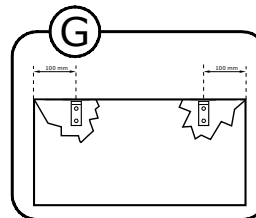
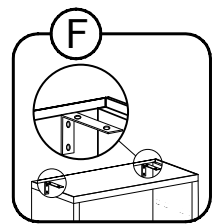
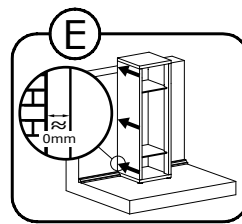
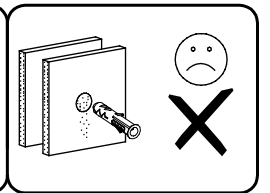
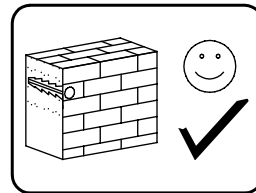
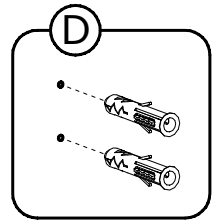
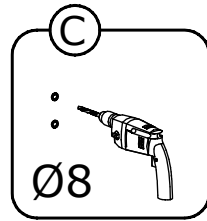
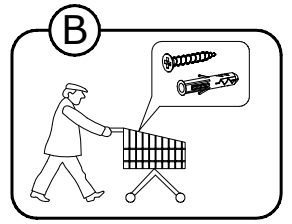
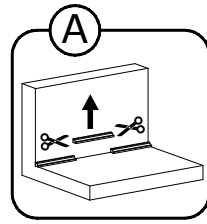
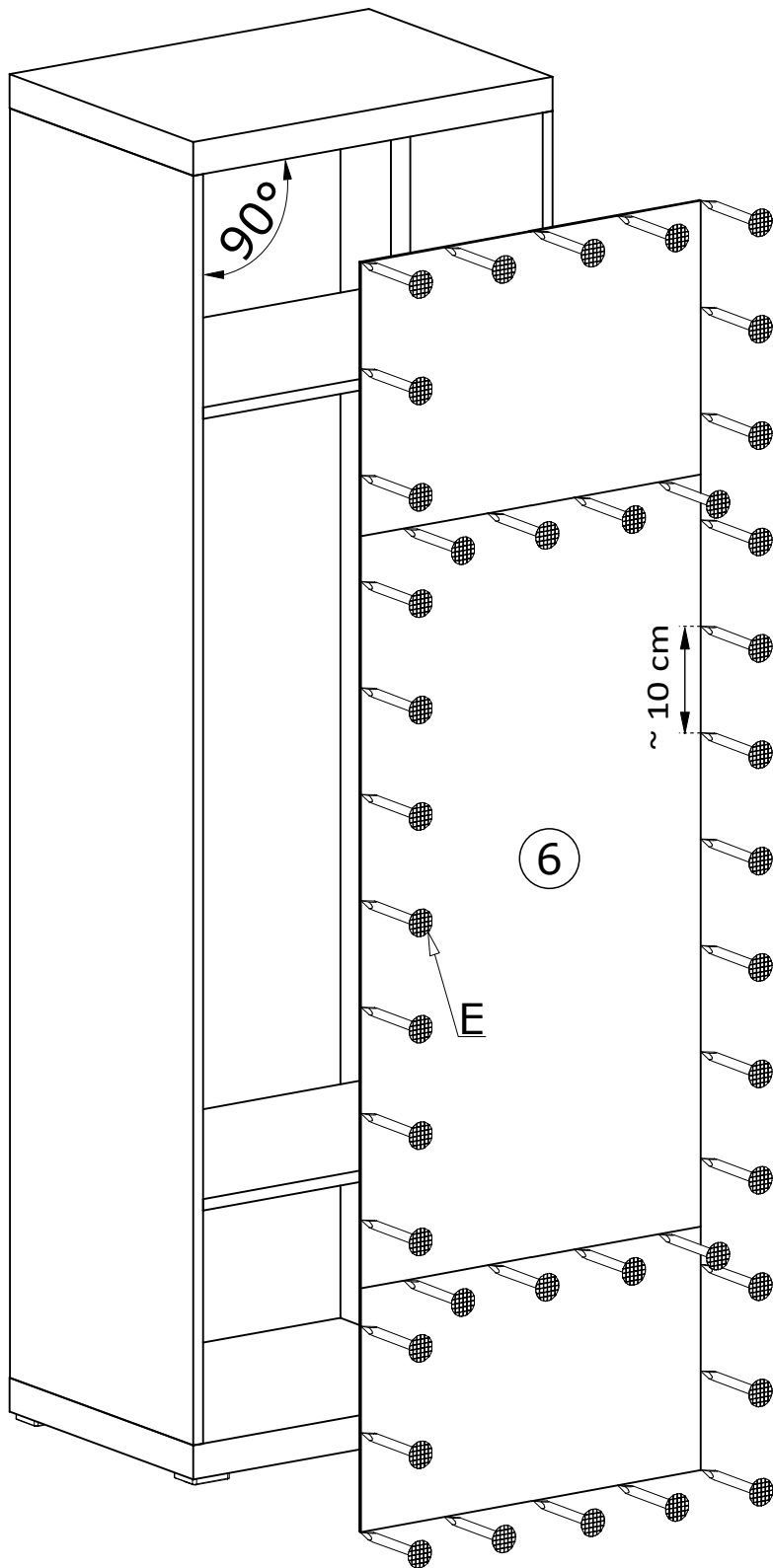

IV

