

NERO 15

PÓŁKOTAPCZAN

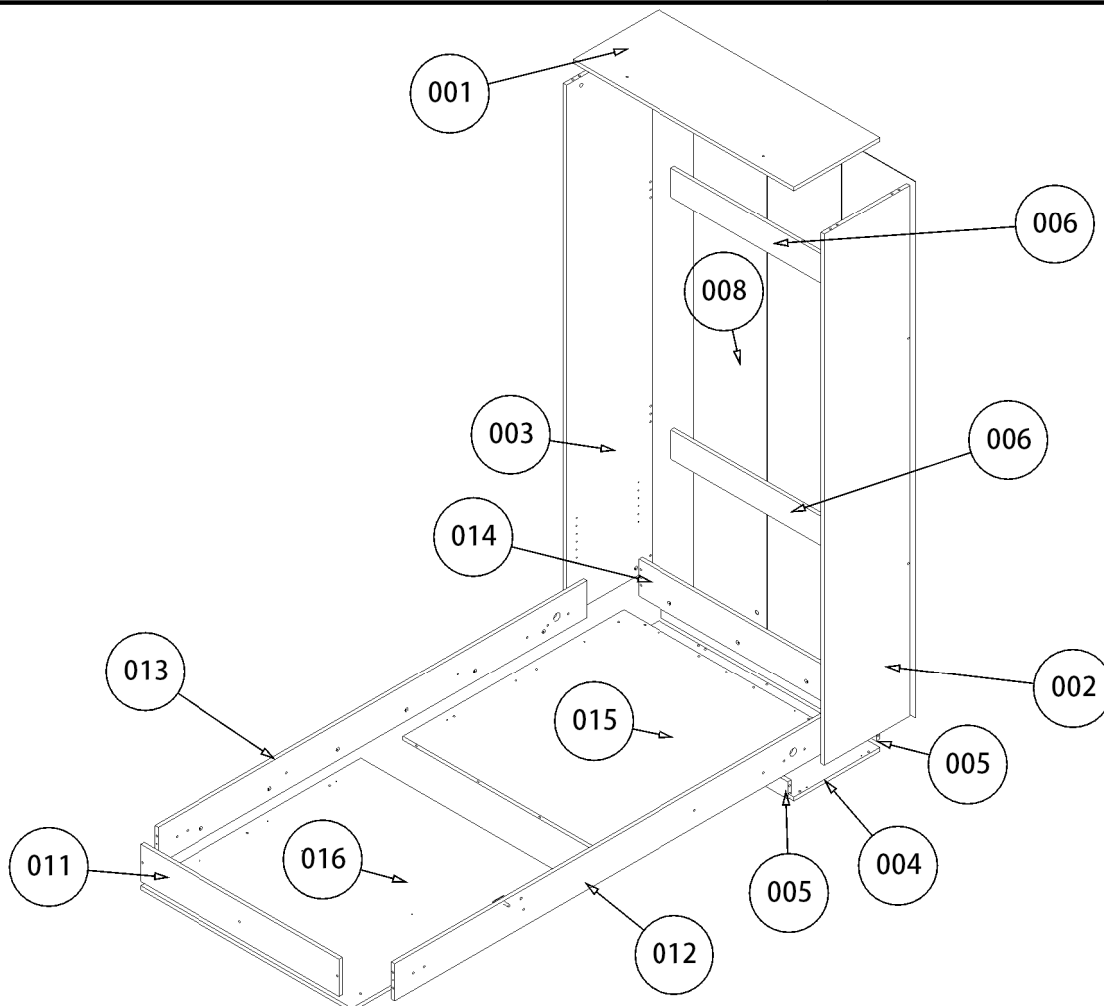

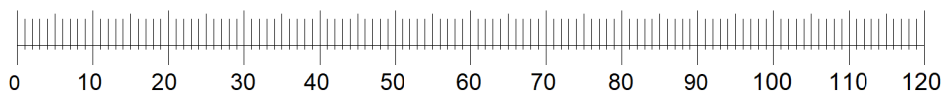
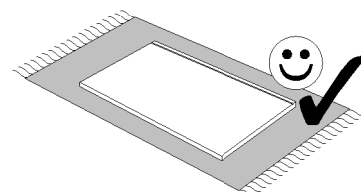
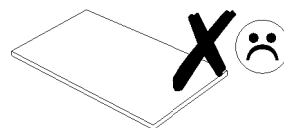
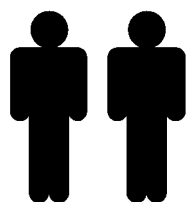
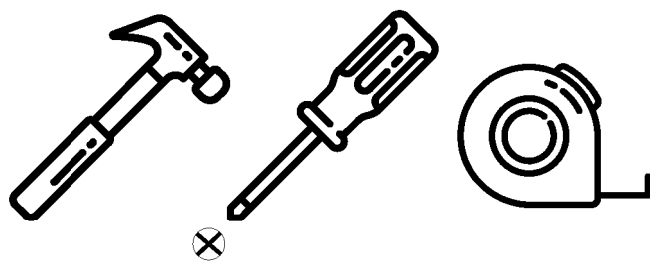
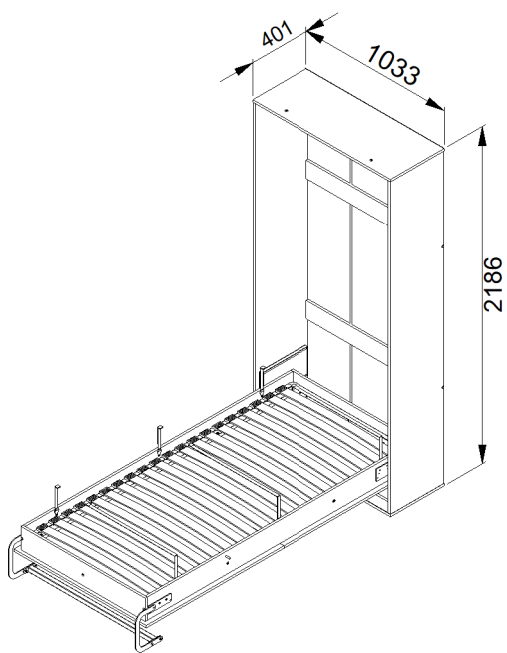
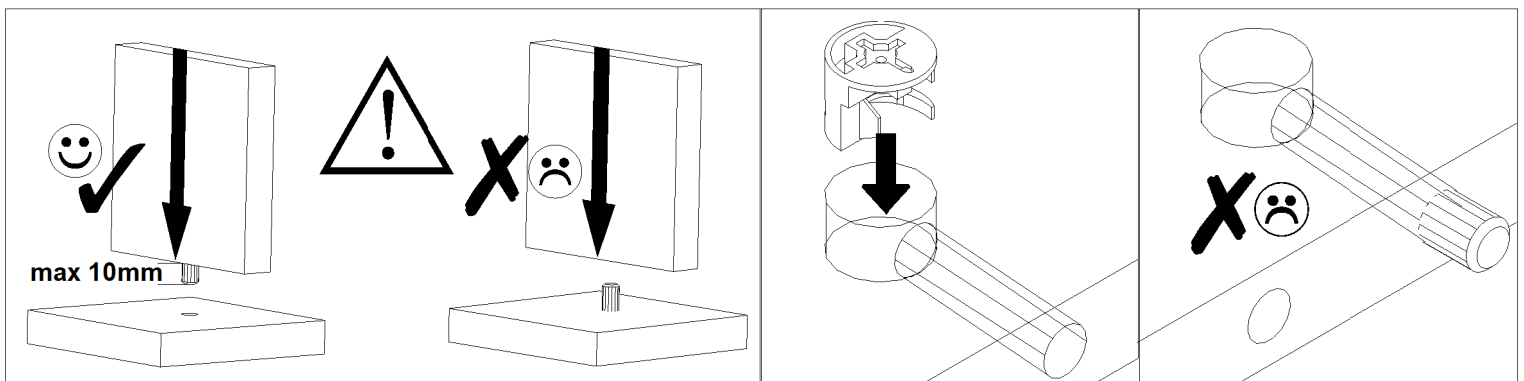
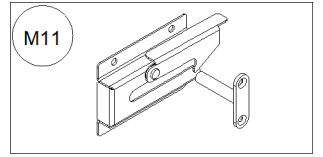
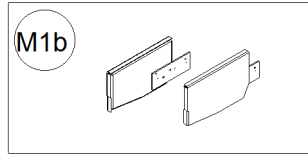
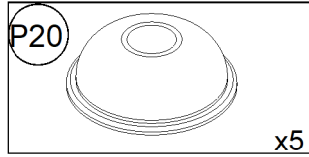
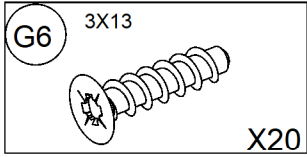
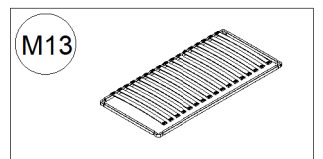
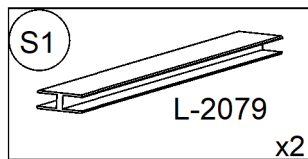
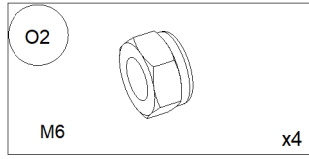
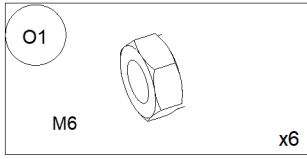
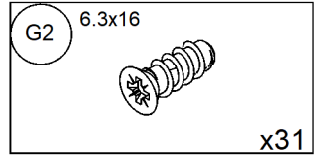
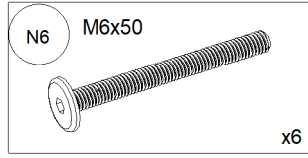
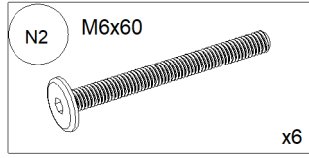
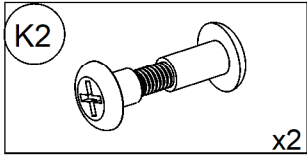
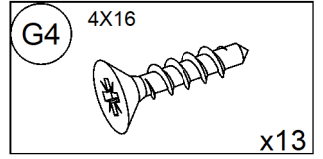
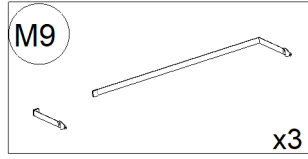
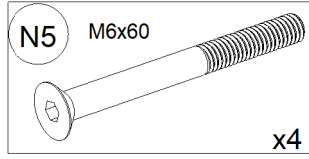
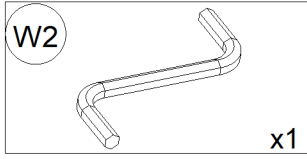
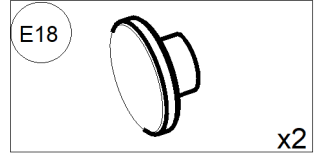
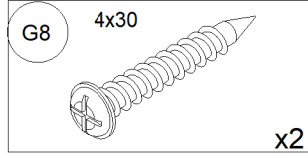
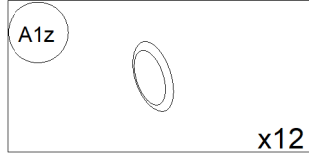
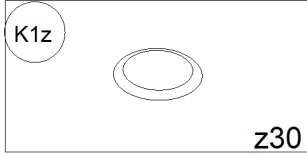
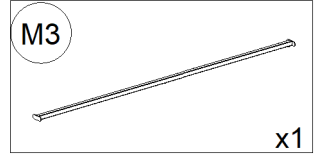
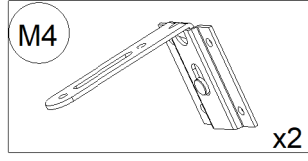
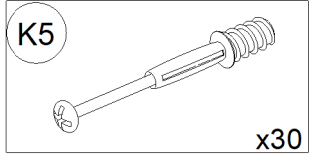
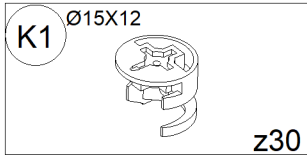
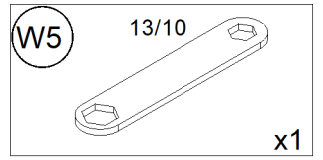
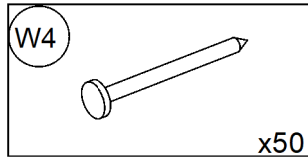
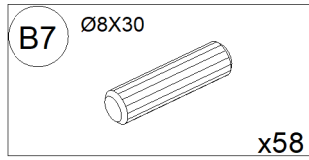
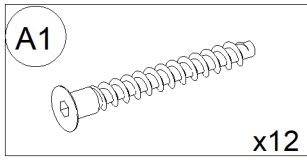

01

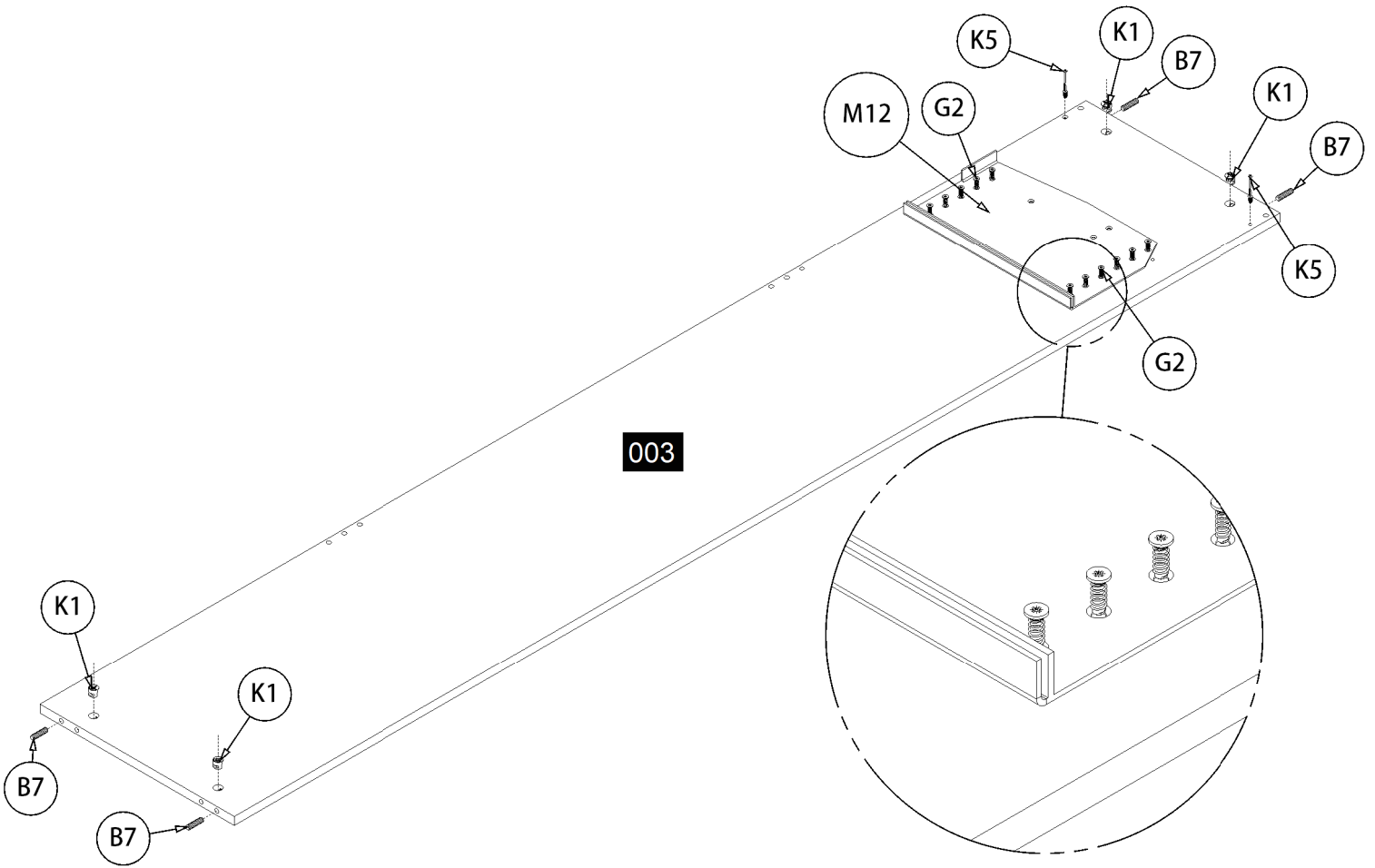
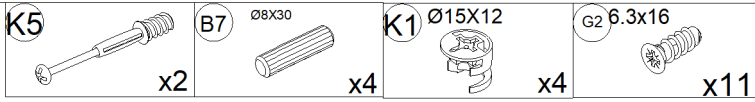

02

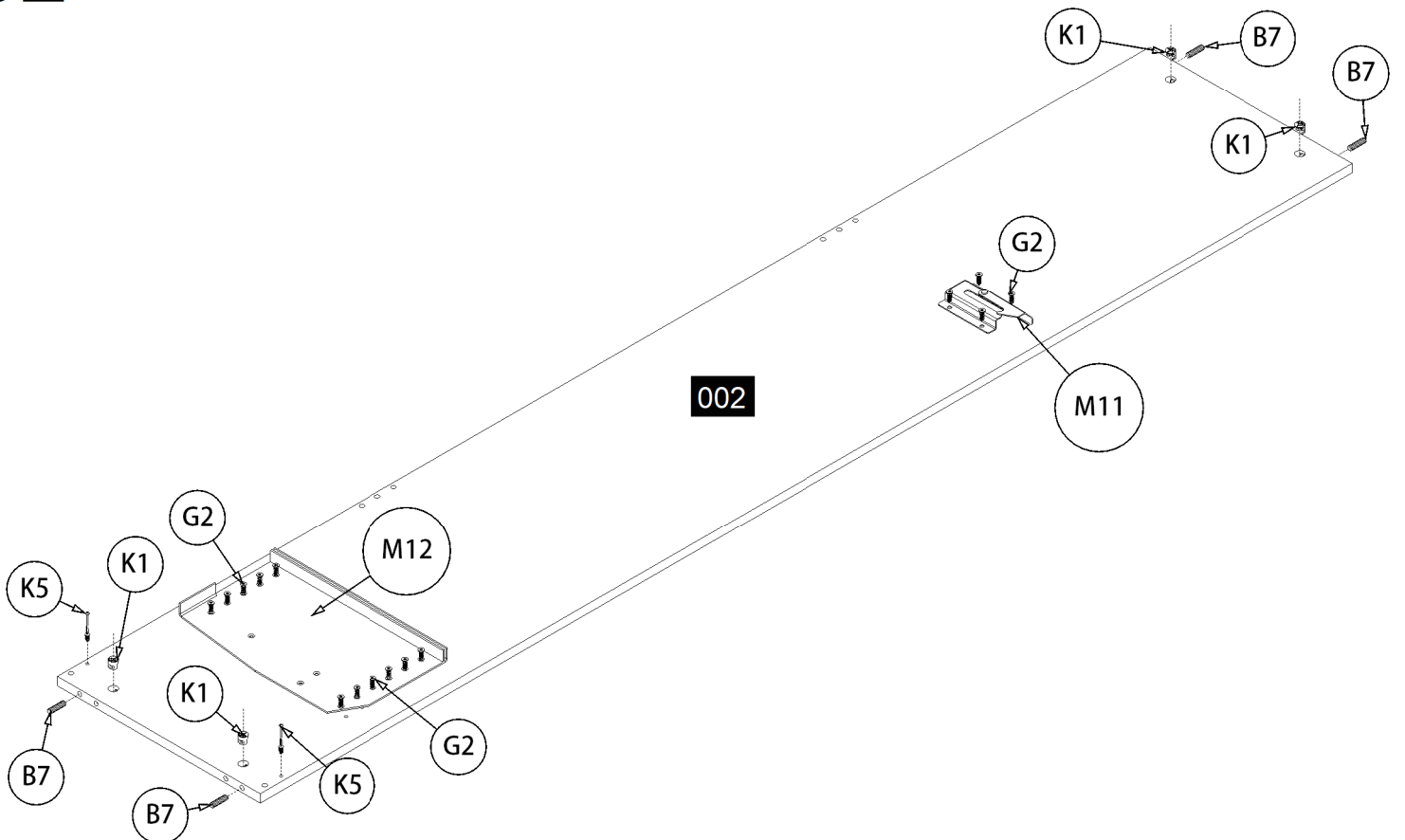
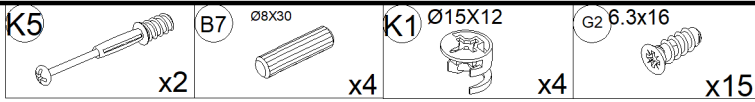

03

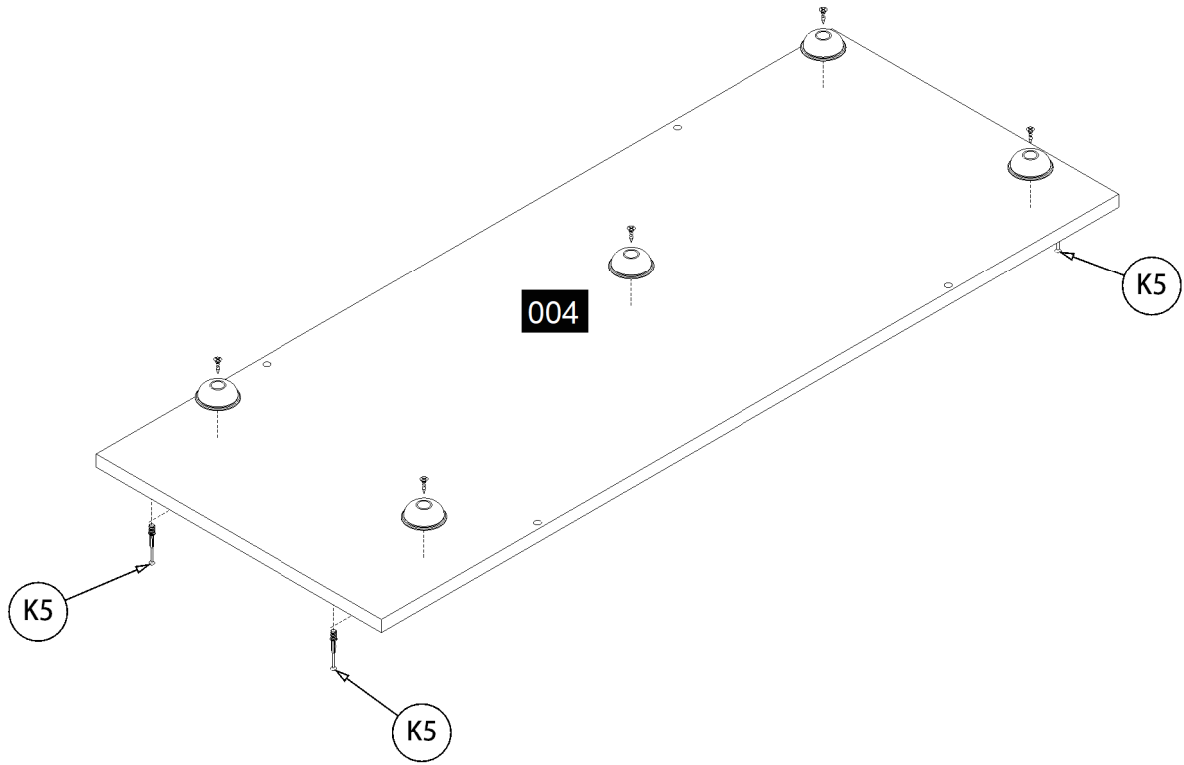
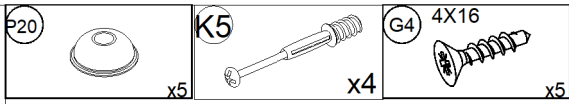

04

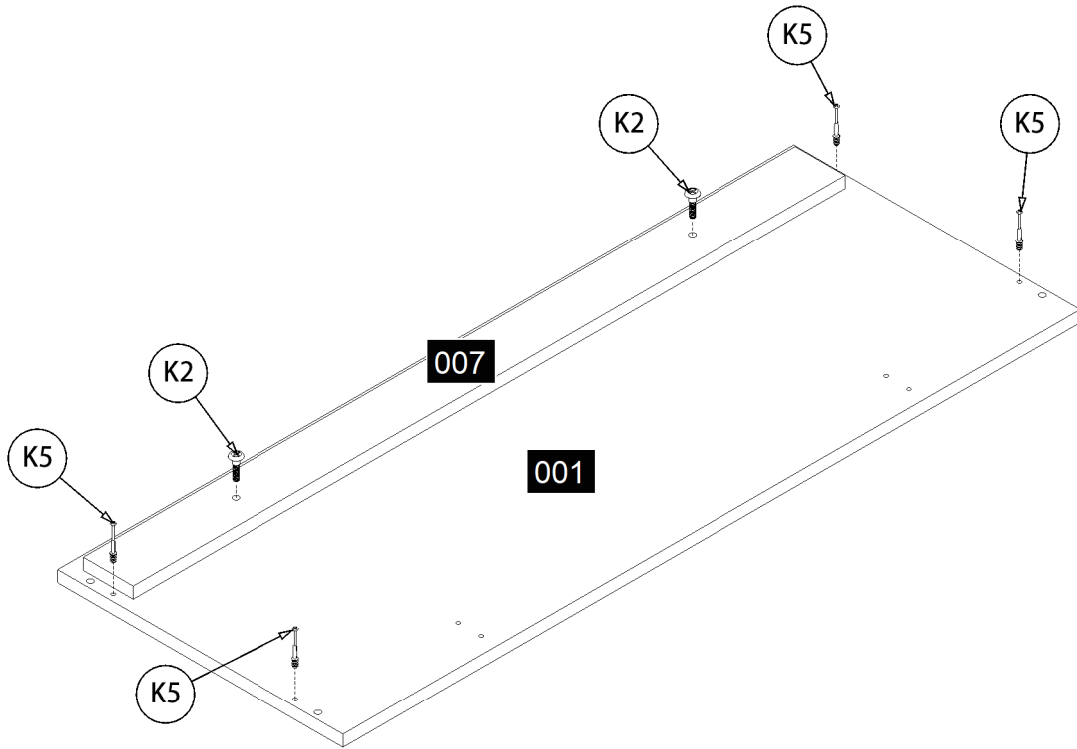
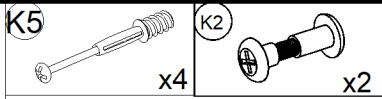

05

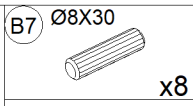

x2

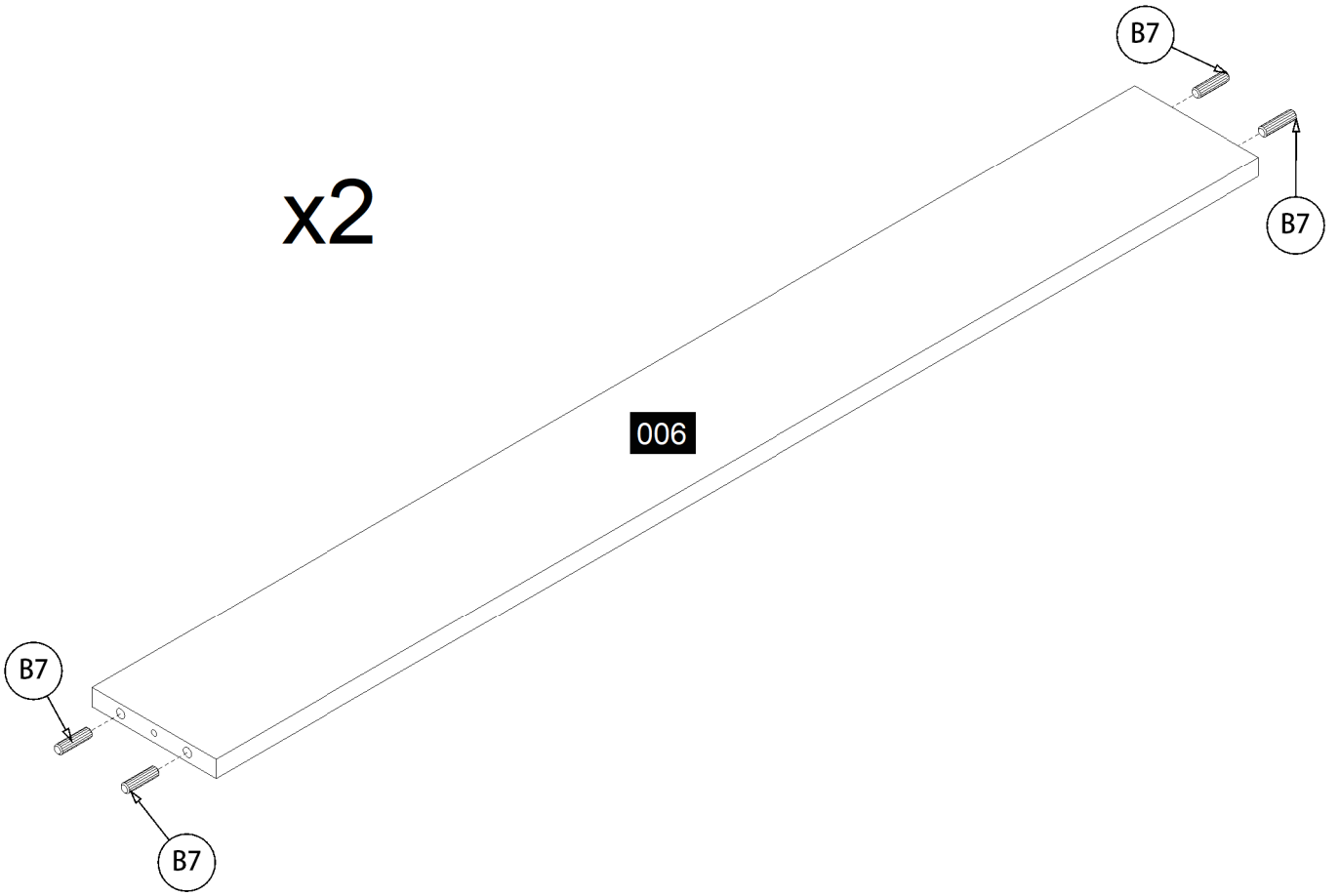

06

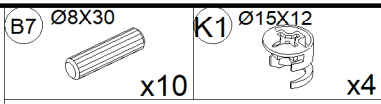

x2

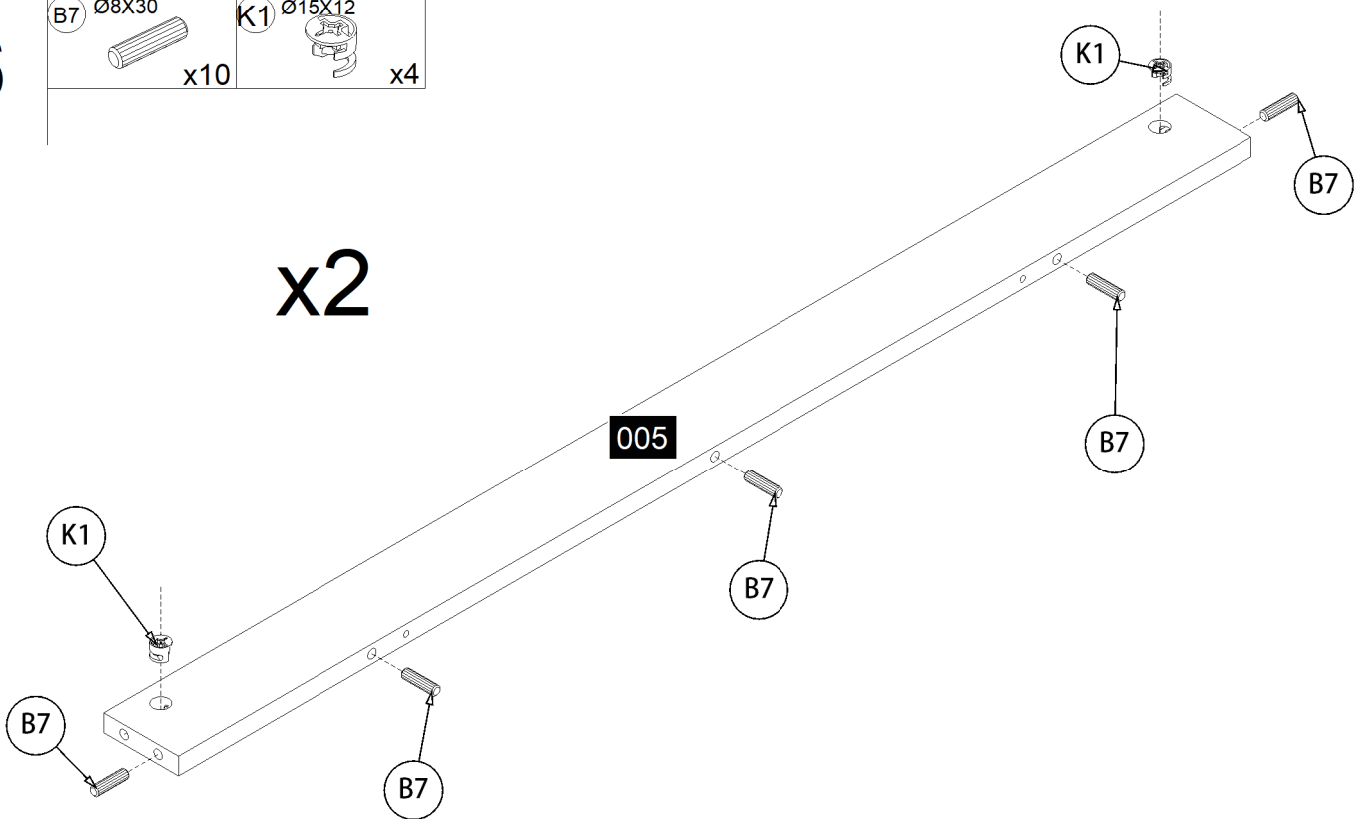

07

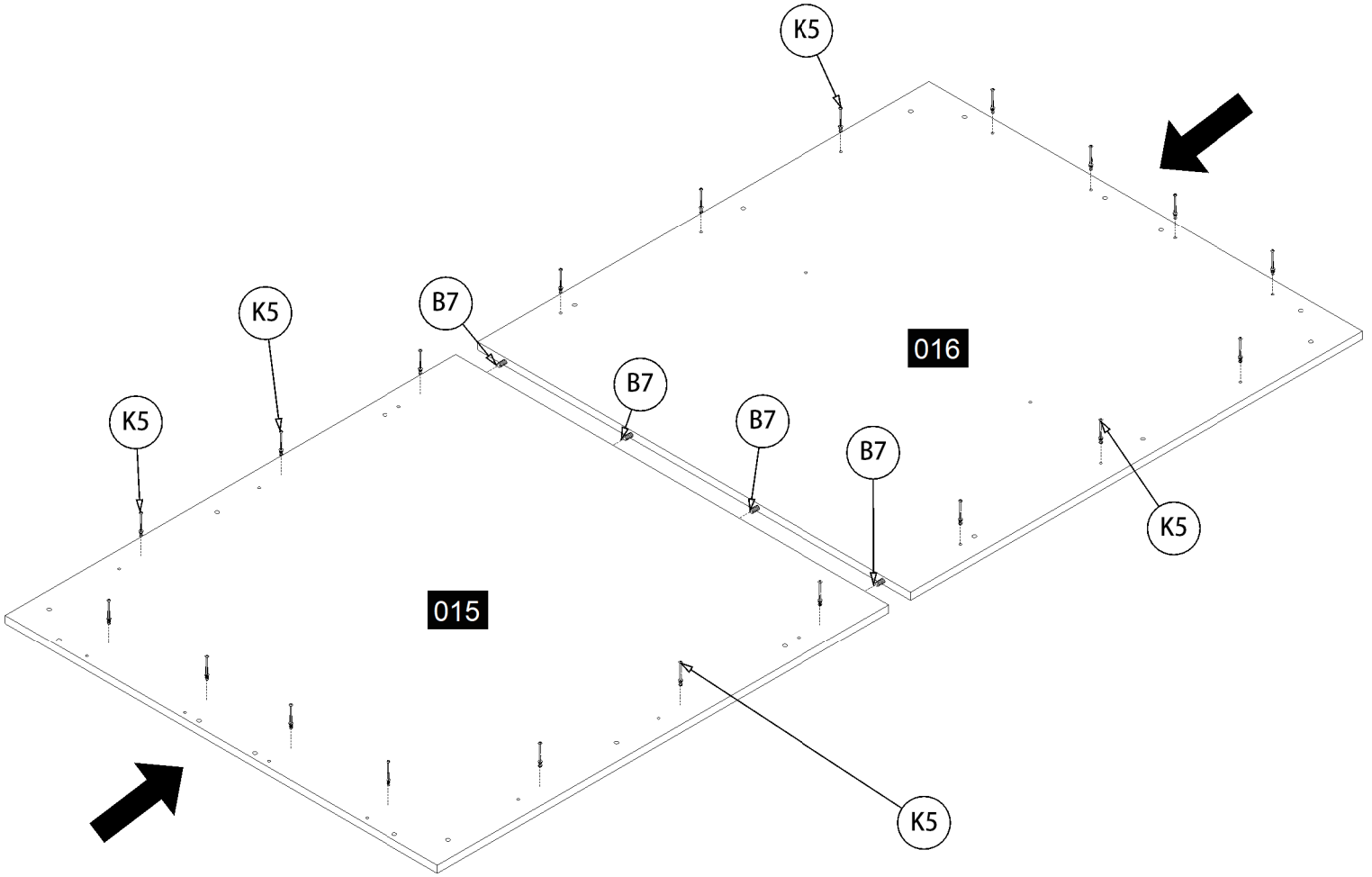
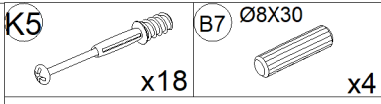

08

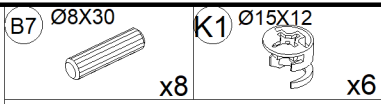

x2

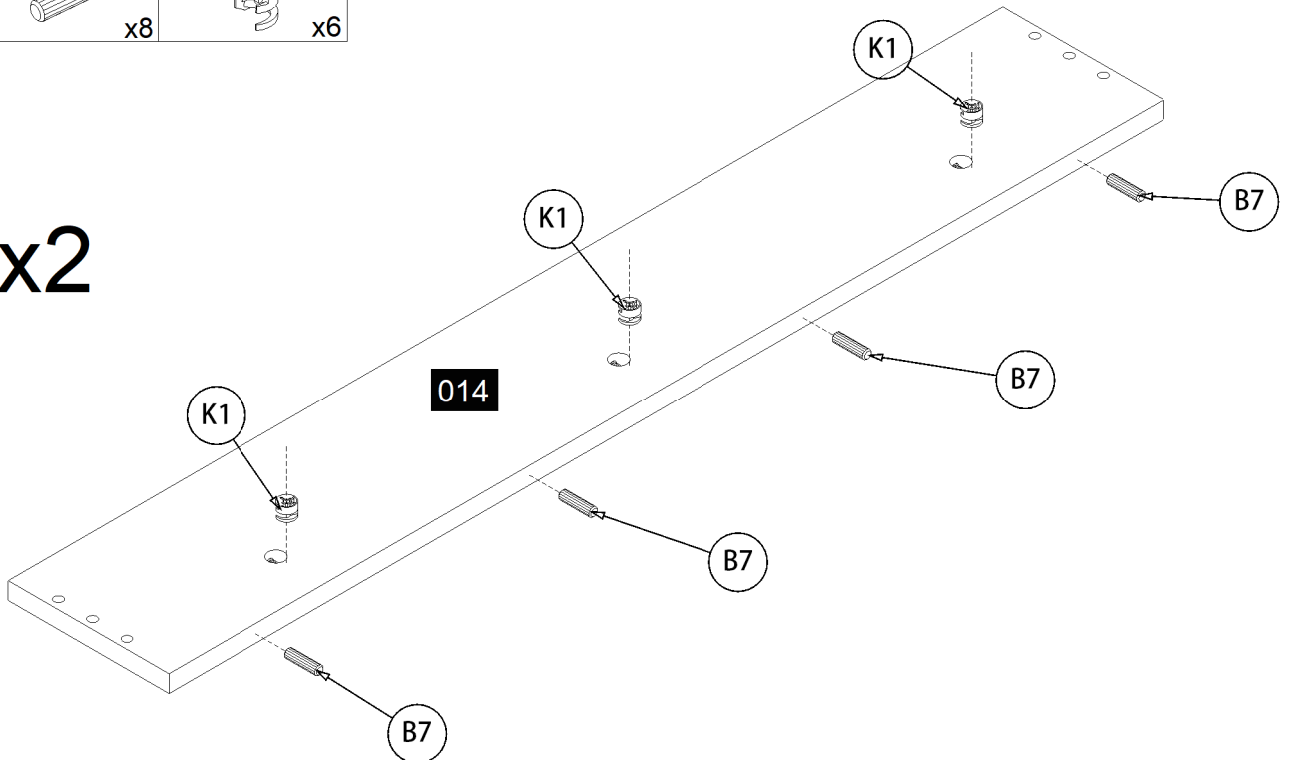

09

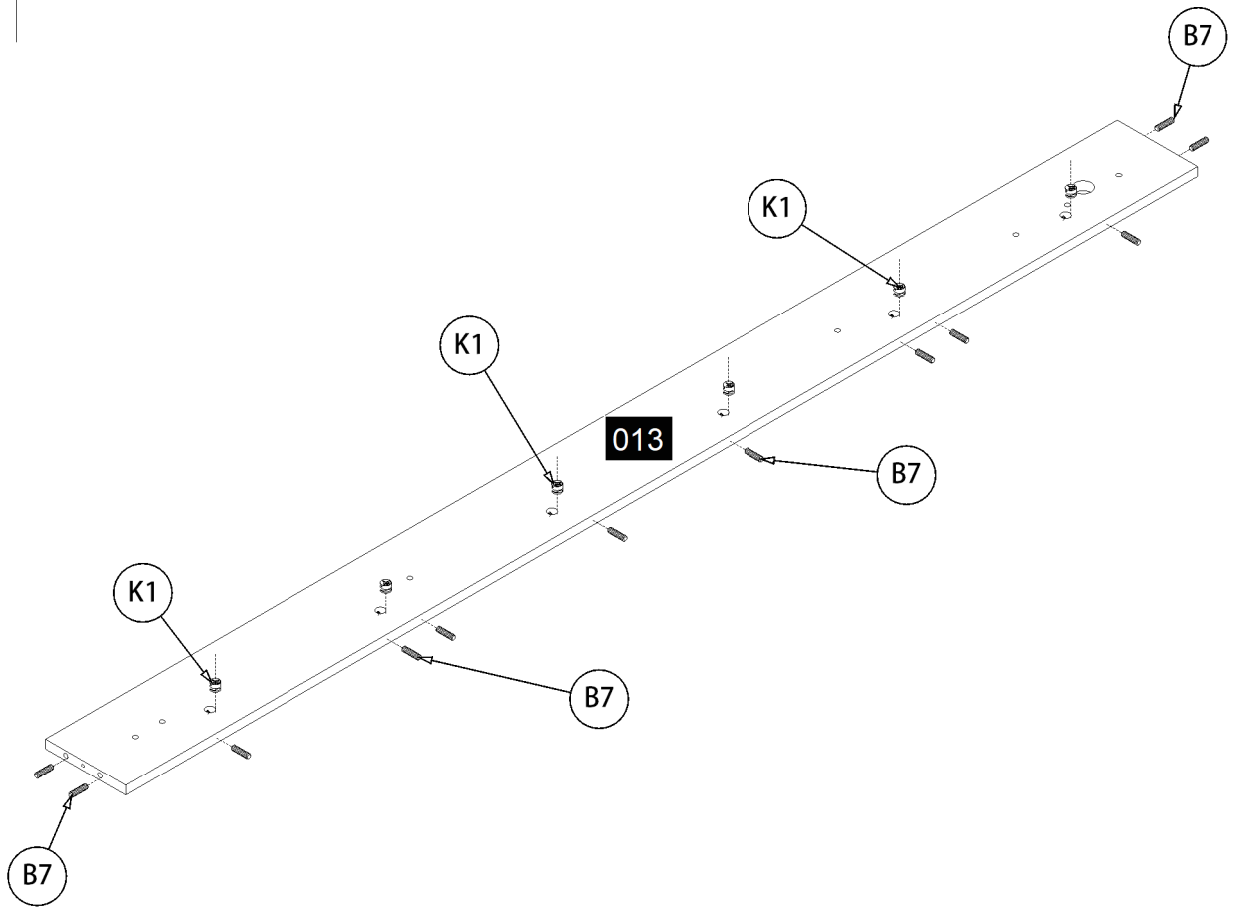
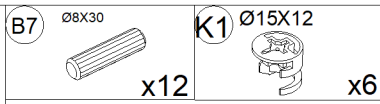

10

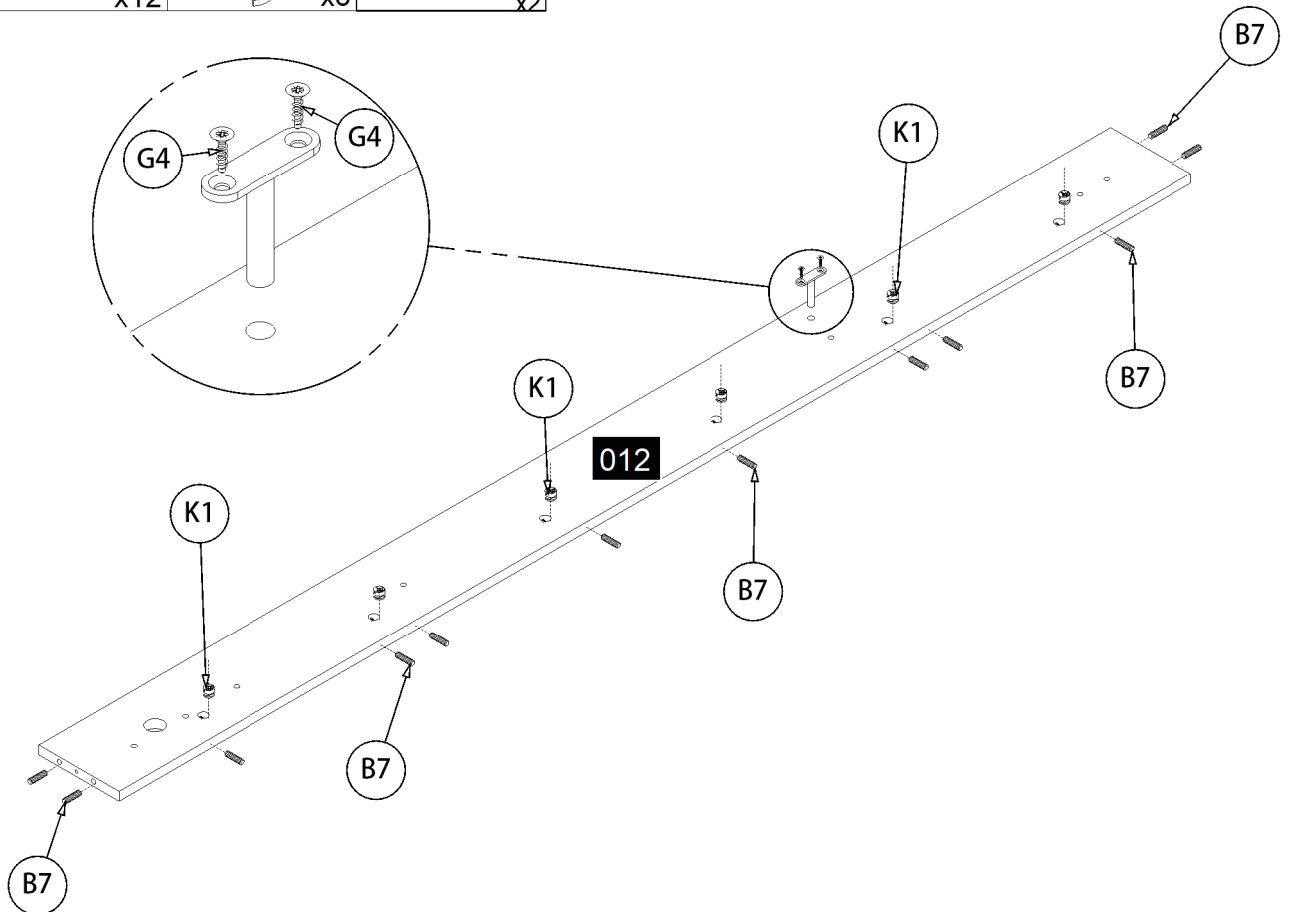
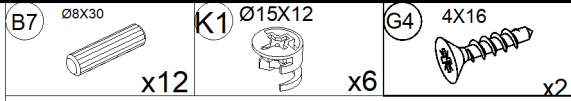

11

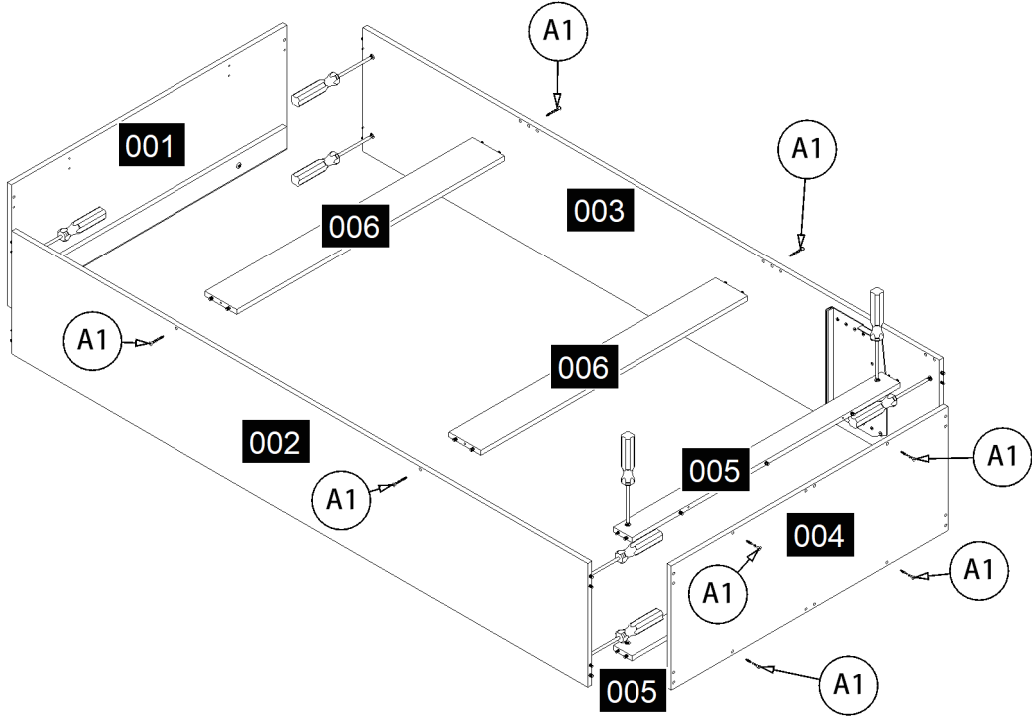
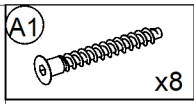

12

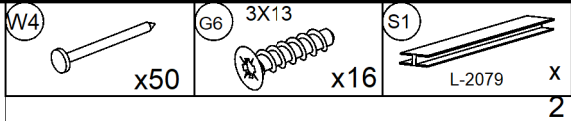

A=B

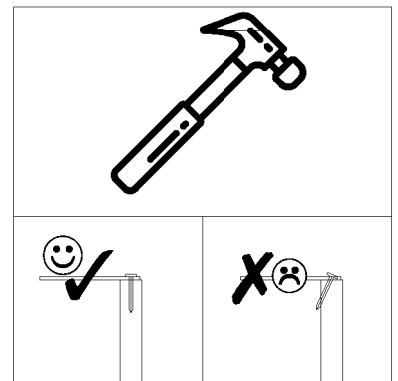
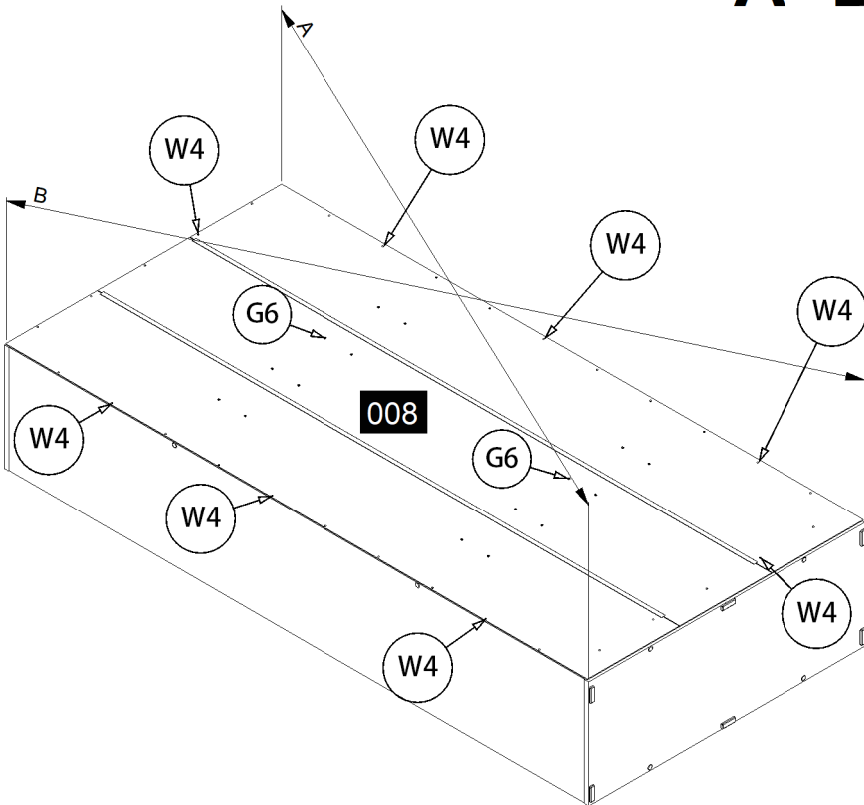
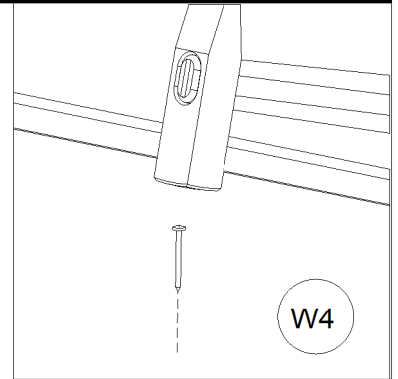

13

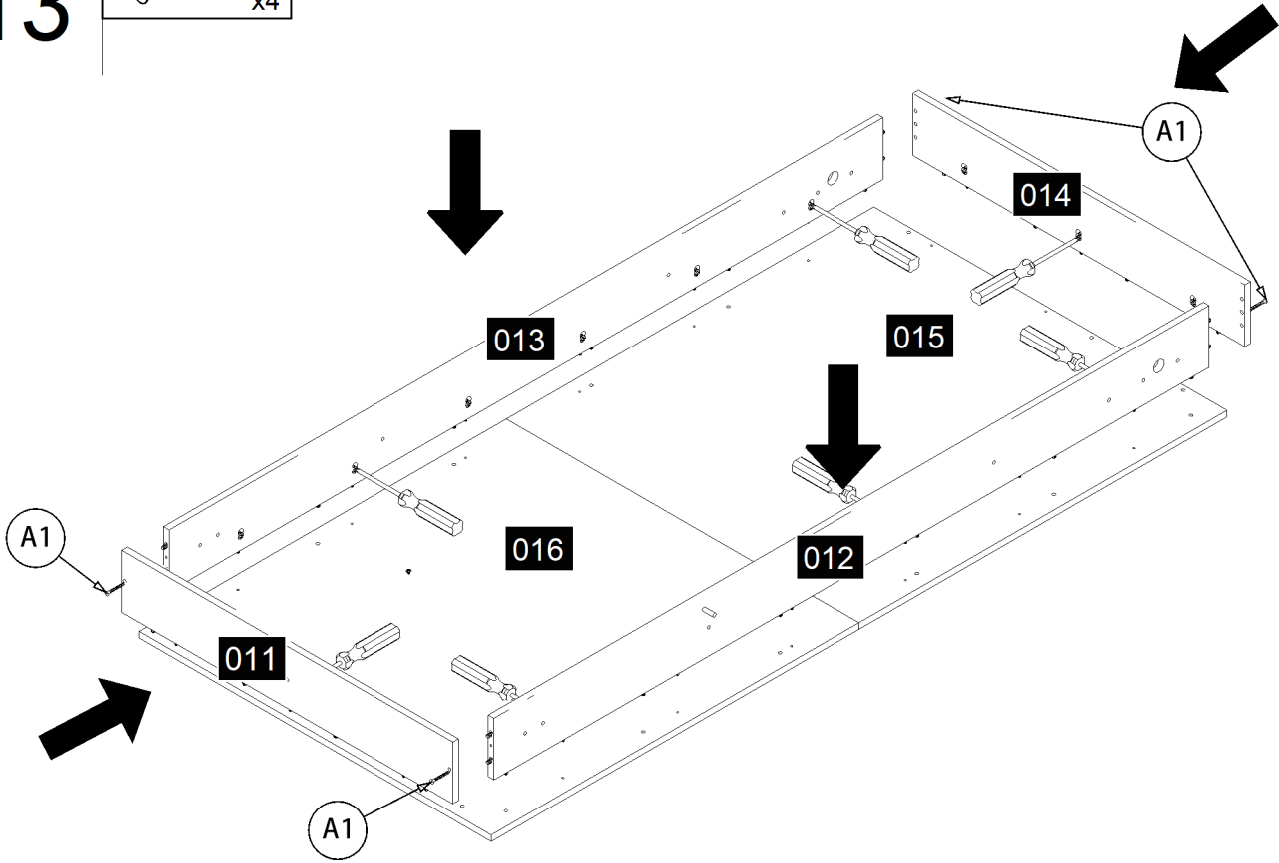
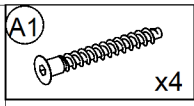

14

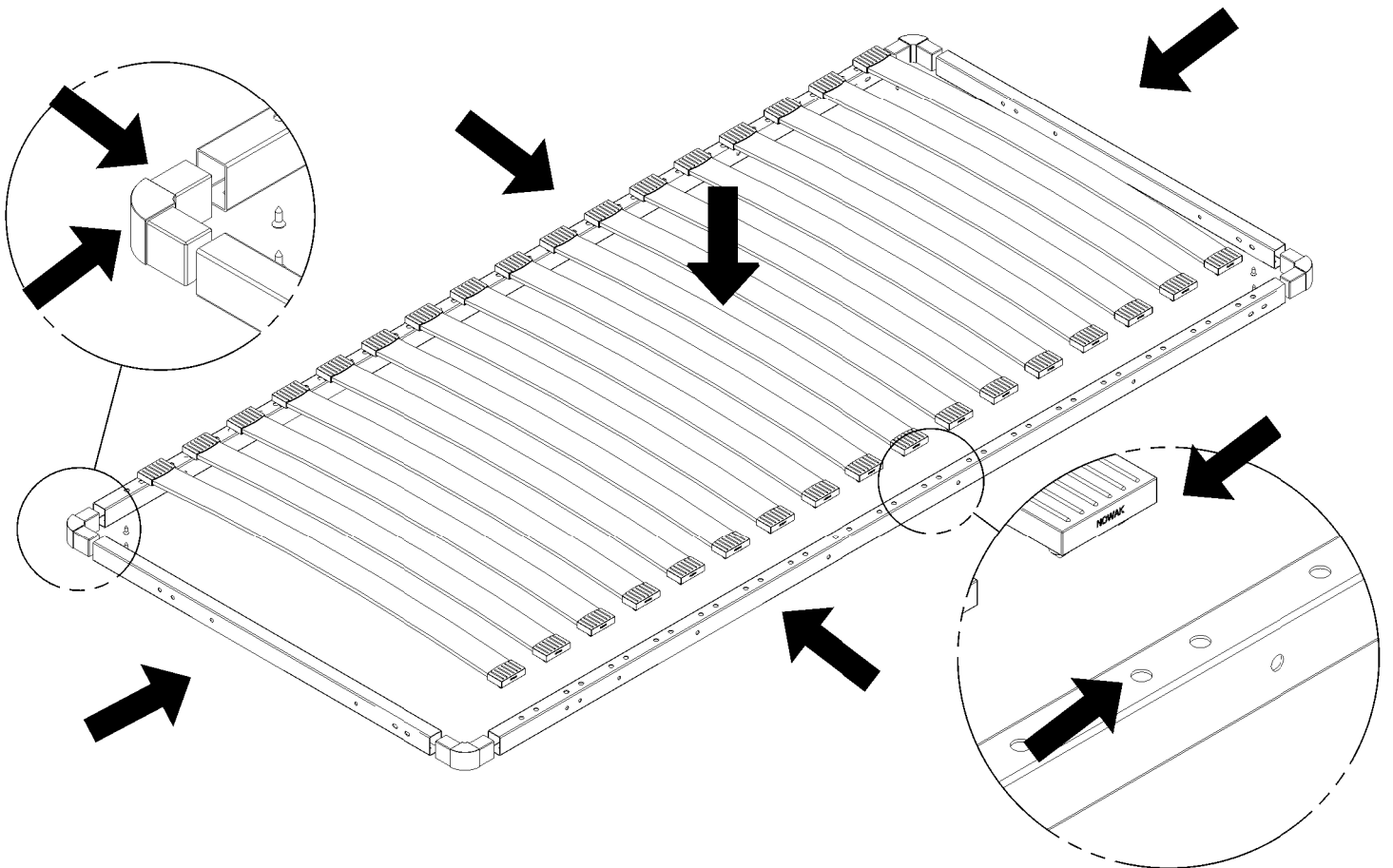

15

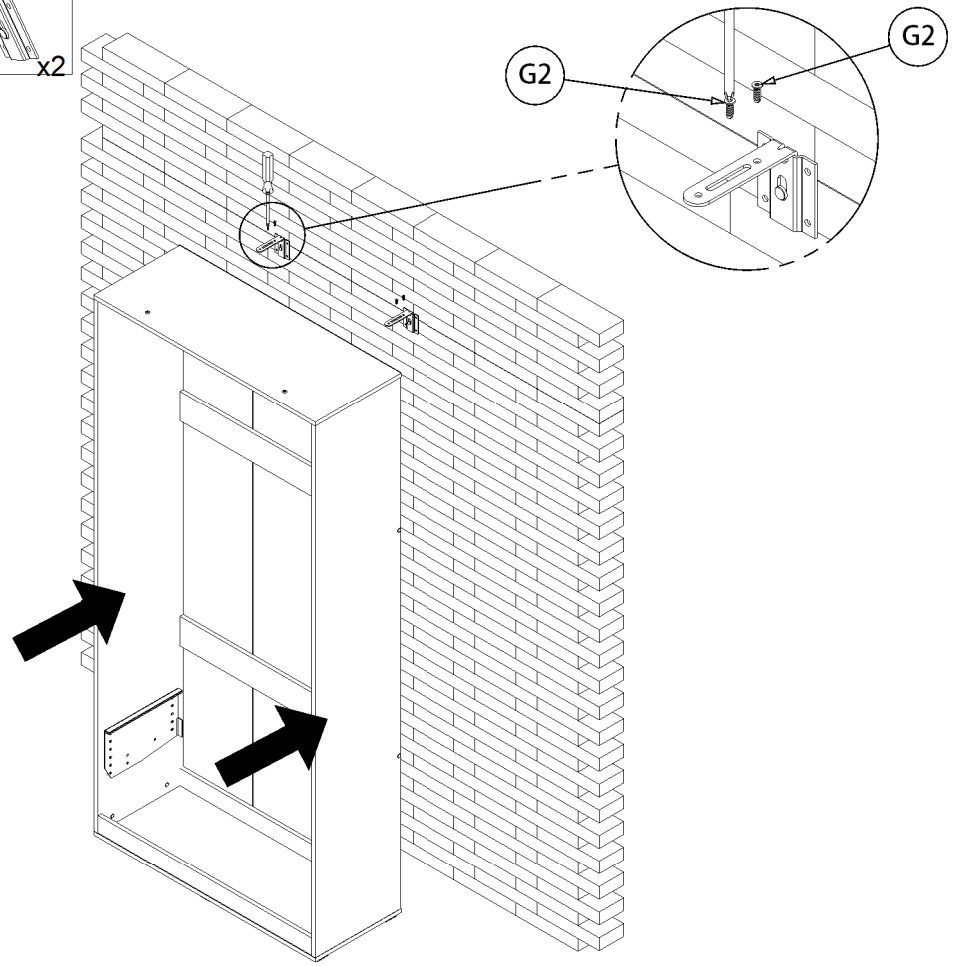
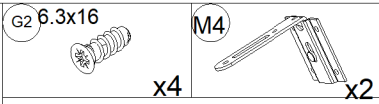

16

