

# DALLAS 5

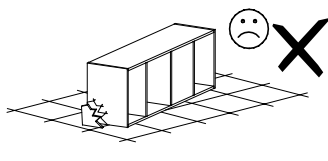

Narzędzia potrzebne do montażu

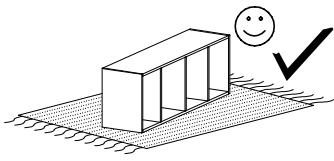
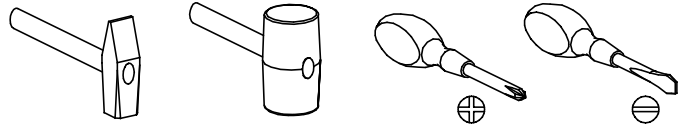

## UWAGA !!!

MONTOWANIE USZKODZONYCH  
ELEMENTÓW POWODUJE UTRATĘ  
GWARANCJI

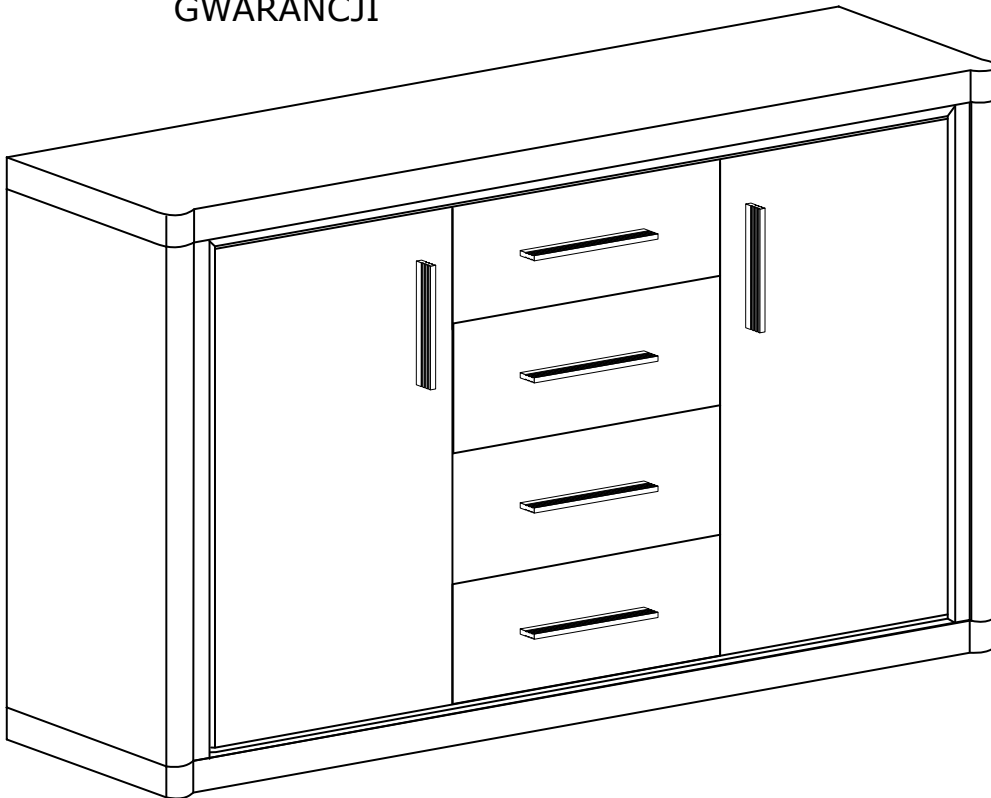

Nr	D[mm]	S[mm]	G[mm]	Ilość
1	1370	450	48	1
2	1370	450	48	1
3	1330	25	16	2
4	800	422	16	1
5	800	422	16	1
6	800	100	32	1
7	800	100	32	1
8	833	405	16	1
9	833	405	16	1
10	440	380	16	2
11	1360	856	2,5	1
12	435	190	16	4
13	400	150	16	4
14	400	150	16	4
15	360	150	16	4
16	390	405	2,5	4
17	772	365	16	1
18	772	365	16	1

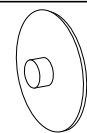

**X1 - 8 St.**



**X2 - 16 St.**

W przypadku reklamacji proszę podać numer pakowacza znajdujący się na kartonie.

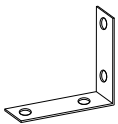

**Y - 2 St.**

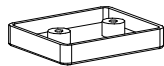

**A - 6 St.**

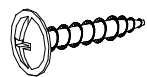

**I - 4 St.**  
3,5x16 mm

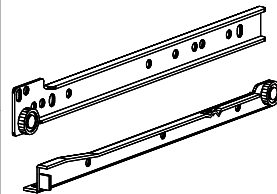

**T - 4 Kpl.**

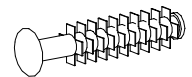

**F - 16 St.**

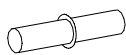

**P - 8 St.**

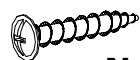

**N - 12 St.**  
4x30 mm

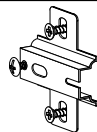

**C - 4 St.**



**L - 26 St.**

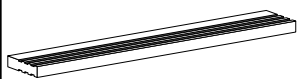

**U - 6 St.**



**G - 8 St.**  
3,5x16 mm

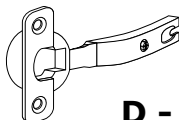

**D - 4 St.**

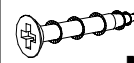

**M - 28 St.**  
4x25 mm



**S - 1 St.**



**E - 90 St.**



**B - 32 St.**

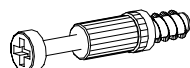

**K - 26 St.**

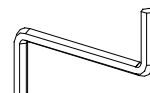

**Z - 1 St.**



**J - 16 St.**  
5x13 mm

I

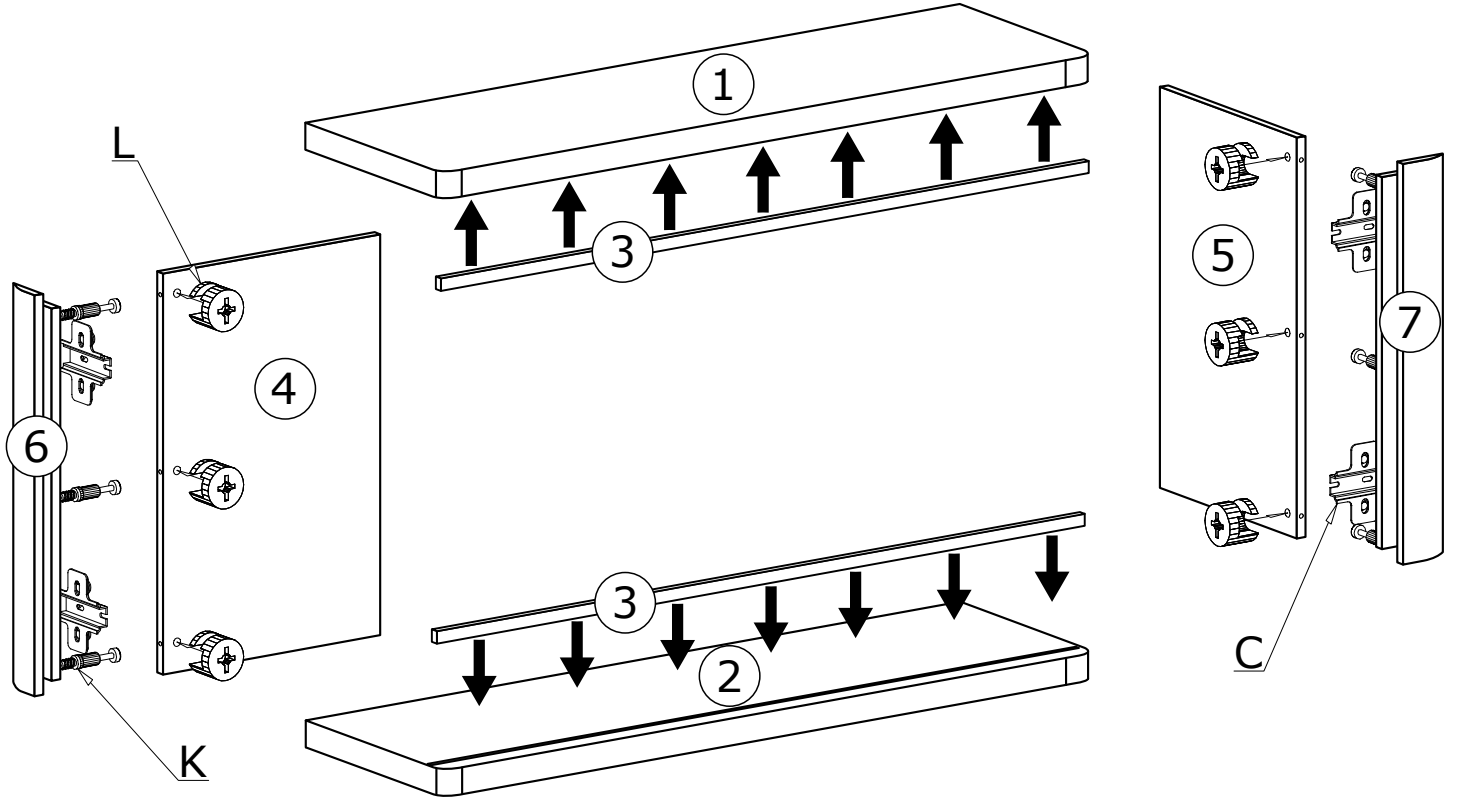

II

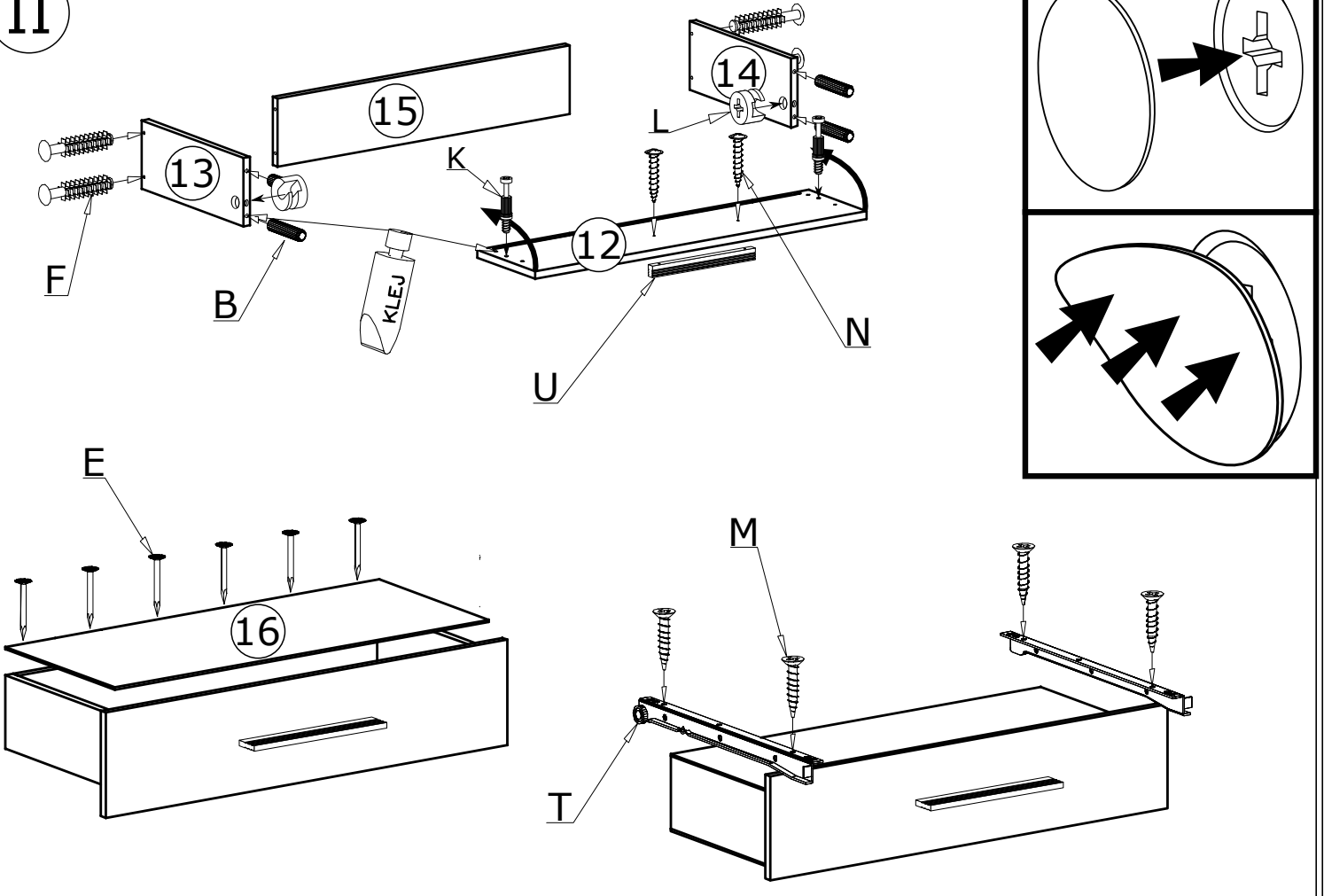

III

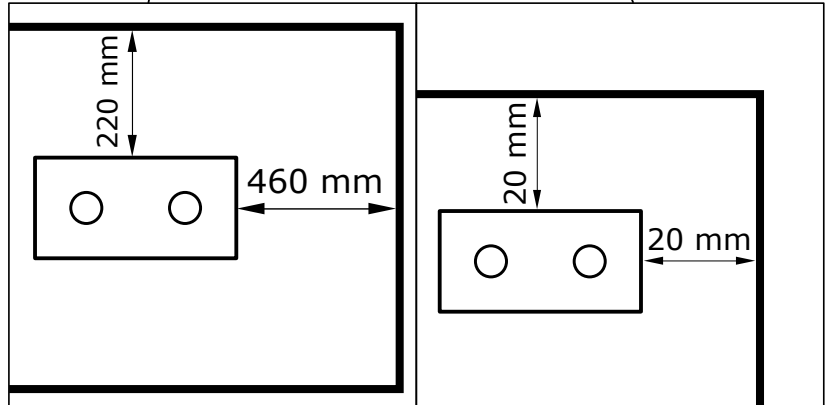
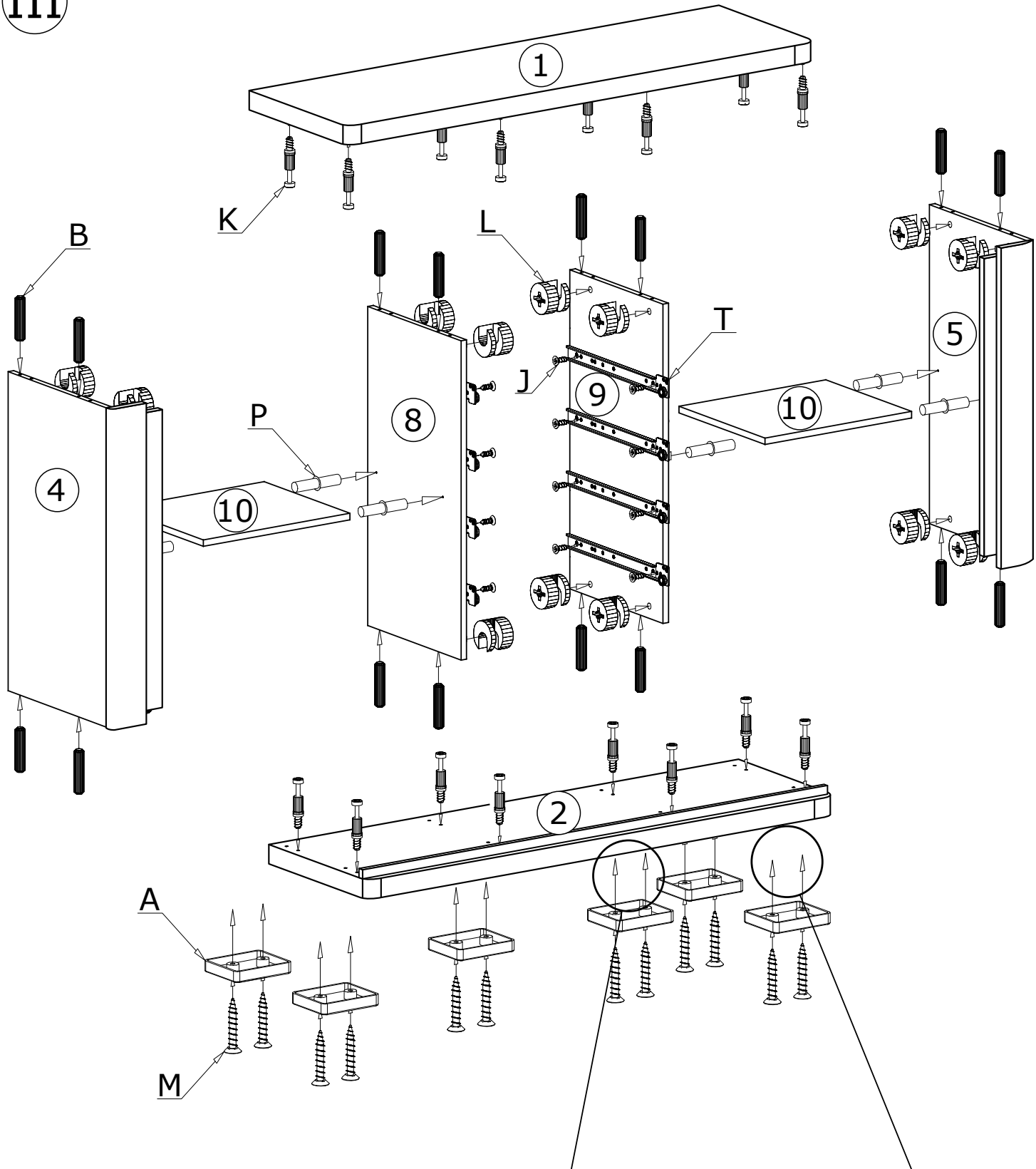

IV

90X 

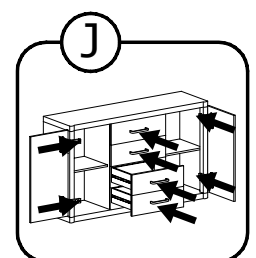
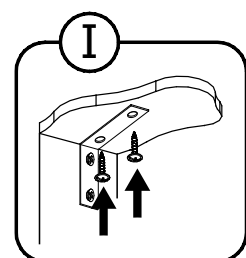
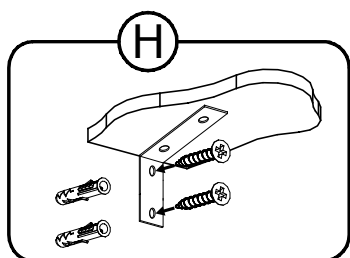
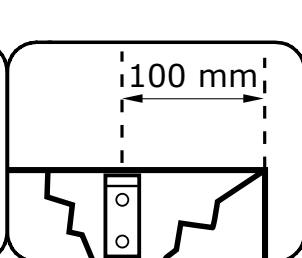
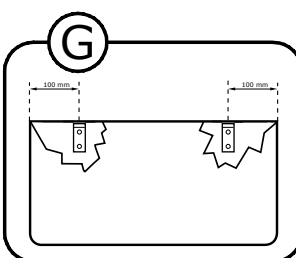
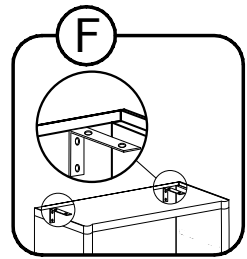
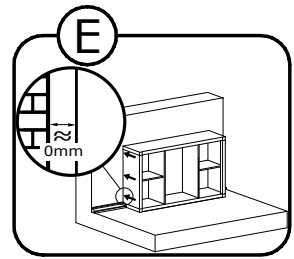
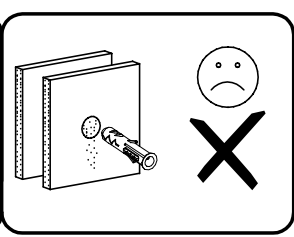
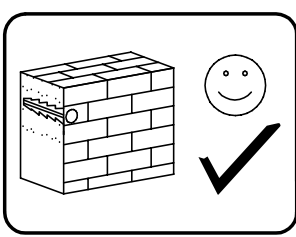
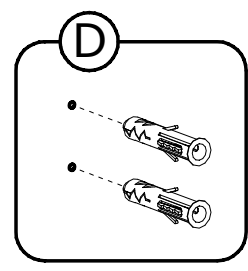
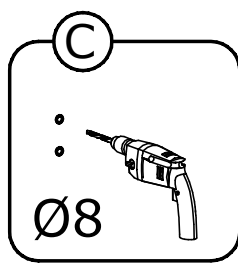
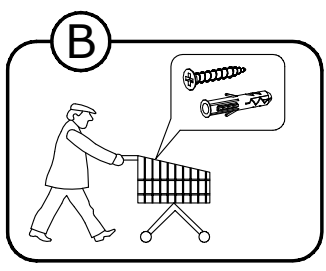
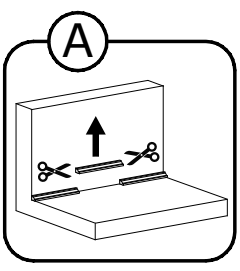
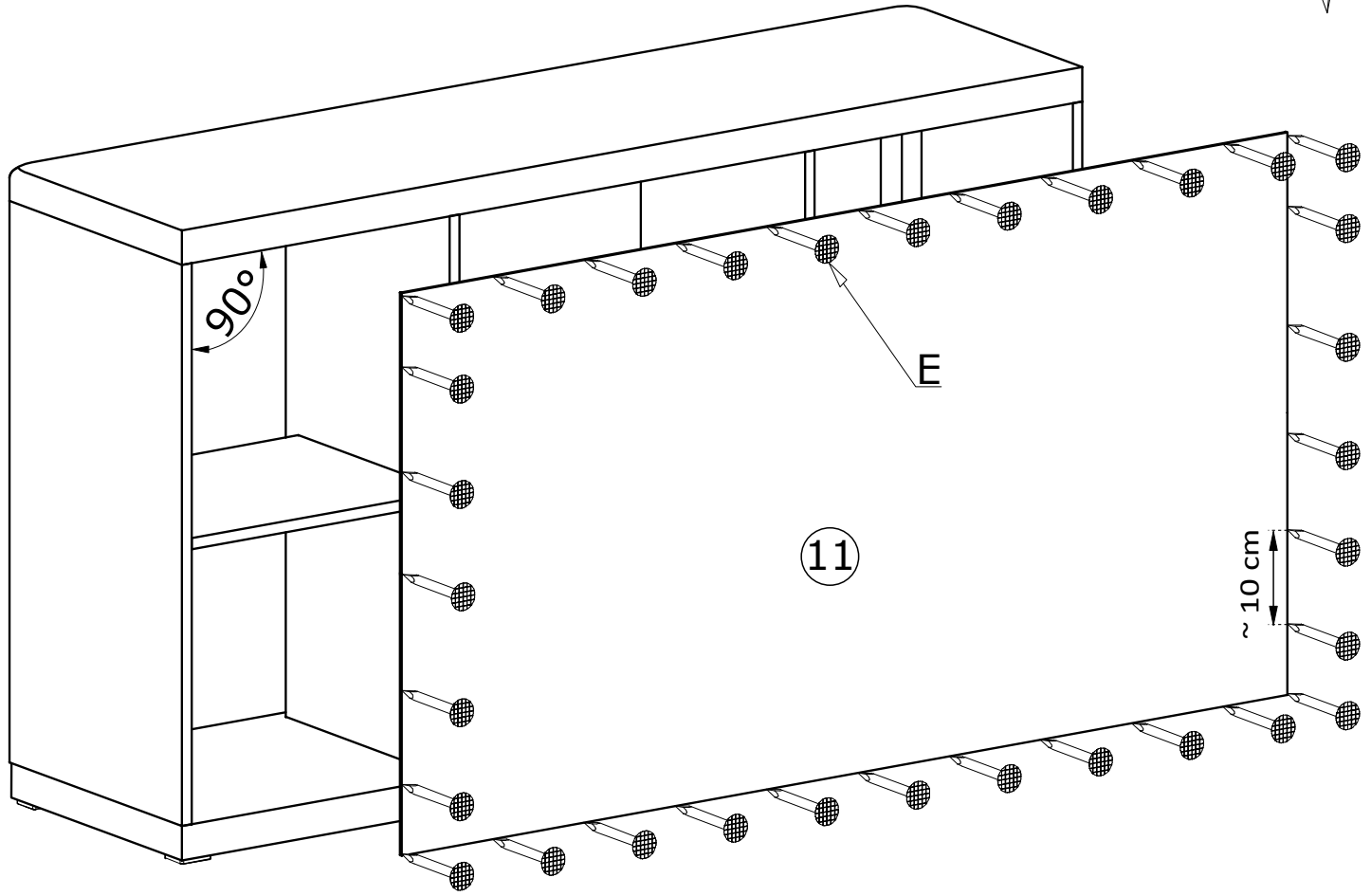

V

