

DALLAS 11

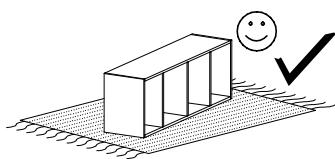

Narzędzia potrzebne do montażu



UWAGA !!!

MONTOWANIE USZKODZONYCH
ELEMENTÓW POWODUJE UTRATĘ
GWARANCJI

Nr	D[mm]	S[mm]	G[mm]	Ilość
1	1070	500	48	1
2	1070	500	48	1
3	1030	25	16	2
4	609	472	16	1
5	609	472	16	1
6	609	100	32	1
7	609	100	32	1
8	455	422	16	1
9	508	430	16	1
10	1035	455	16	1
11	508	430	16	1
12	1060	223	2,5	1
13	1060	447	2,5	1
14	510	420	16	1

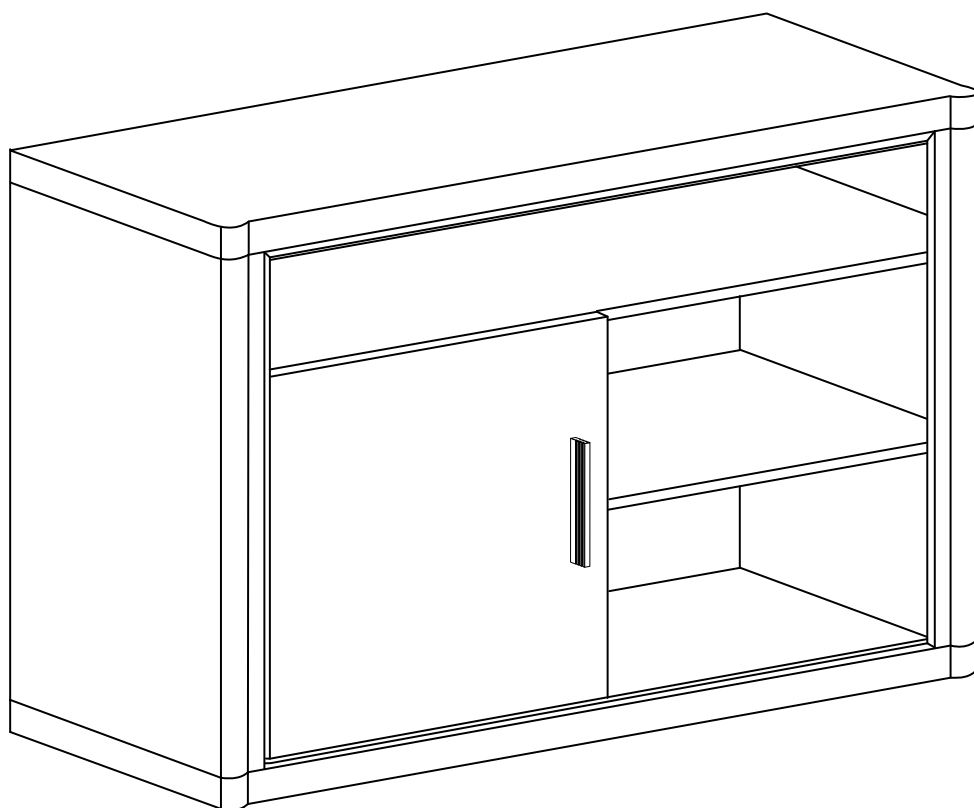

W przypadku reklamacji proszę podać numer pakowacza znajdujący się na kartonie.

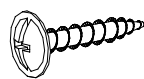

I - 4 St.
3,5x16 mm

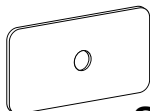

S - 10 St.

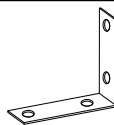

Y - 2 St.

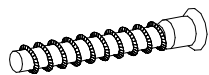

W - 6 St.

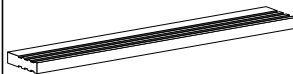

U - 1 St.

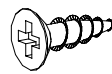

G - 14 St.
3,5x16 mm



L - 14 St.

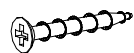

R - 10 St.
4x25 mm



E - 30 St.

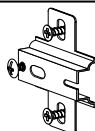

C - 2 St.

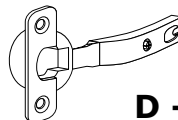

D - 2 St.

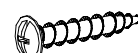

N - 2 St.
4x30 mm

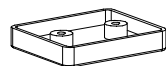

A - 5 St.



B - 14 St.

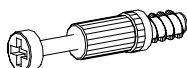

K - 14 St.

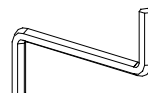

Z - 1 St.

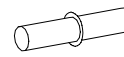

P - 8 St.

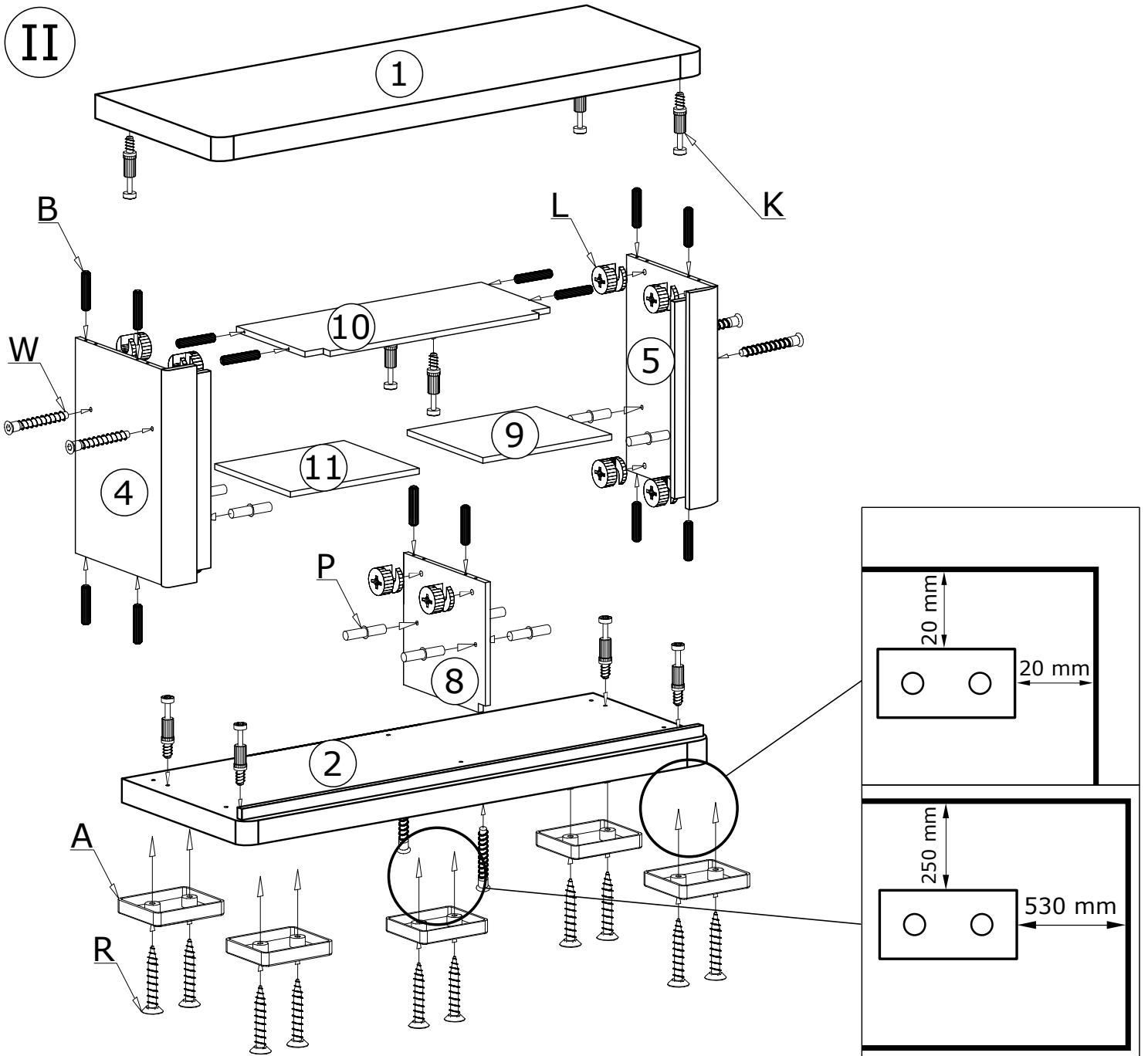
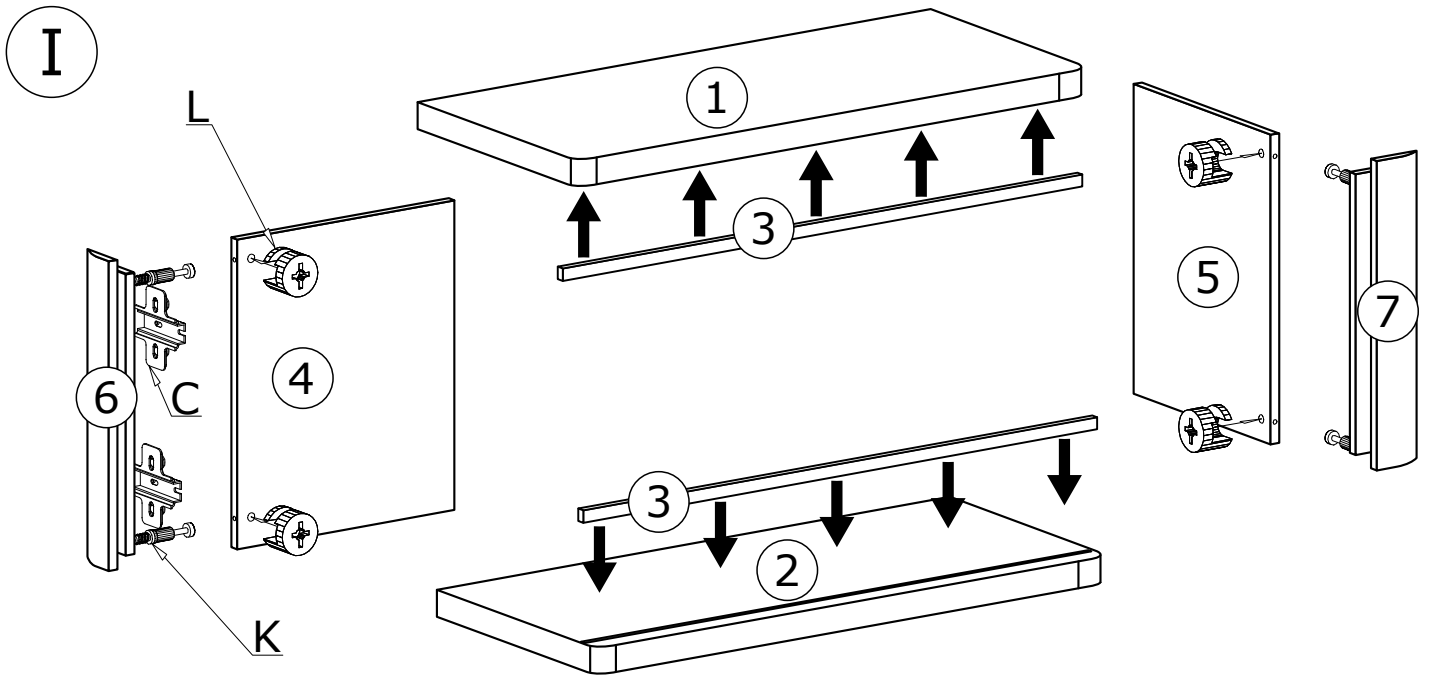

IV

30X 

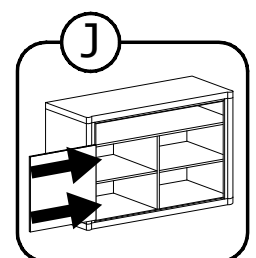
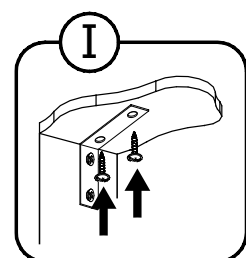
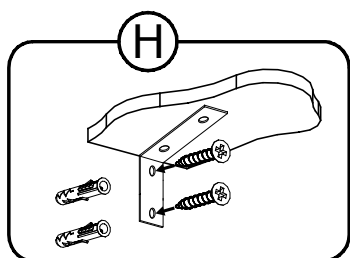
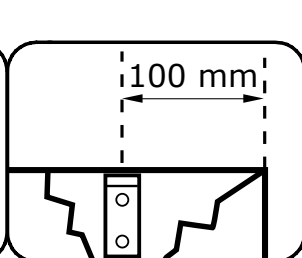
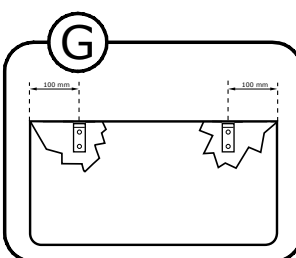
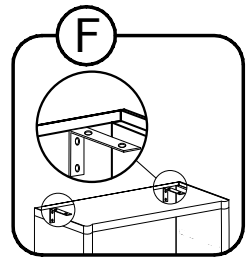
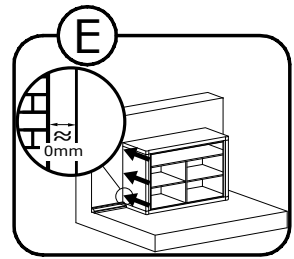
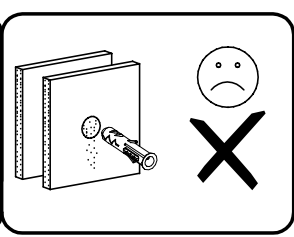
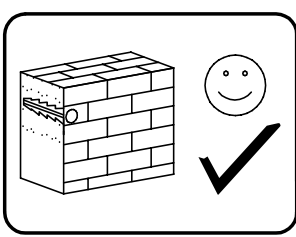
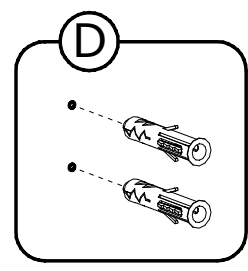
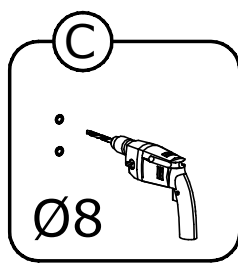
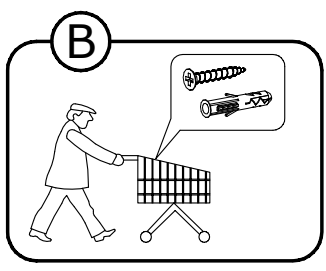
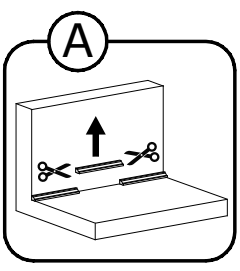
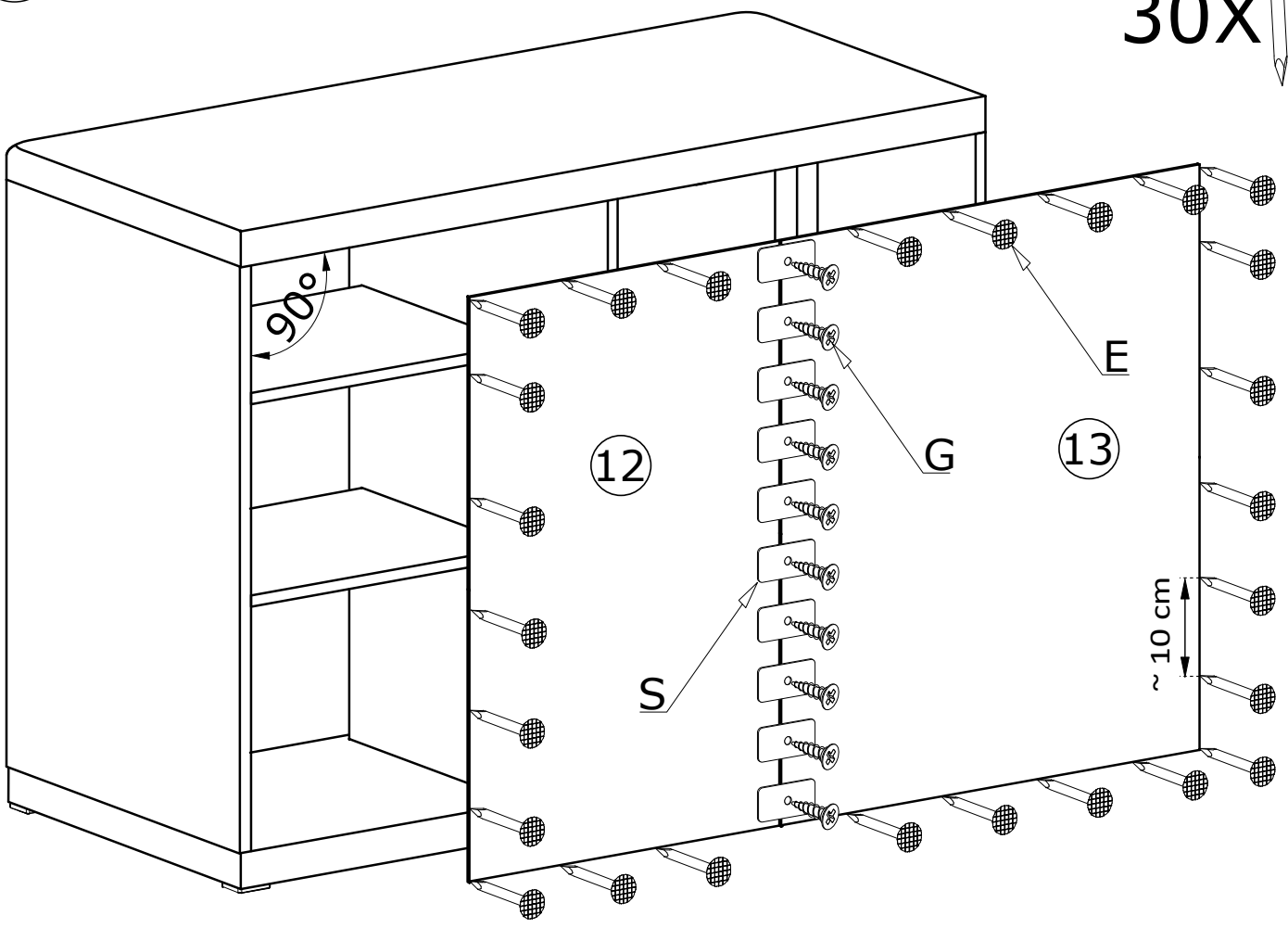

V

