

# APOLLO 17

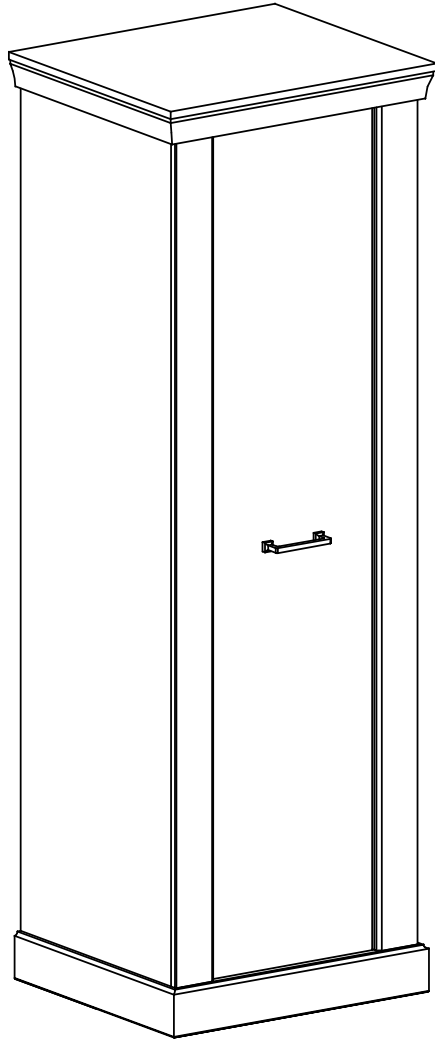

Narzędzia potrzebne do montażu

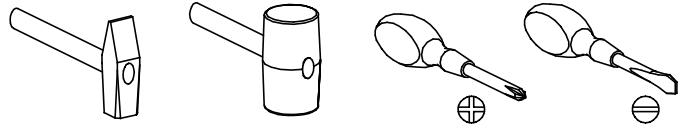

## UWAGA !!!

MONTOWANIE USZKODZONYCH  
ELEMENTÓW POWODUJE UTRATĘ  
GWARANCJI

Nr	D[mm]	S[mm]	G[mm]	Ilość
1	1960	540	16	1
2	1960	540	16	1
3	573	555	16	1
4	573	523	16	2
5	640	100	16	1
6	572	100	16	1
7	572	100	16	1
8	668	580	71	1
9	1892	298	2,5	1
10	1865	100	32	1
11	1865	100	32	1
12	1800	400	16	1
13	605	80	16	1
14	407	55	16	1

W przypadku reklamacji proszę podać numer pakowacza znajdujący się na kartonie.

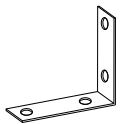

**Y - 2 St.**

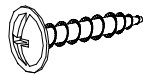

**I - 4 St.**  
3,5x16 mm

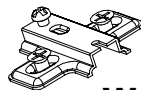

**W1 - 2 St.**

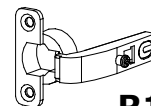

**R1 - 2 St.**



**F - 1 St.**

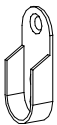

**R - 2 St.**

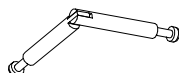

**O - 4 St.**

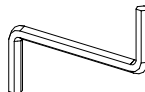

**Ł - 1 St.**

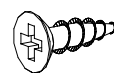

**G - 12 St.**  
3,5x16 mm



**L - 32 St.**

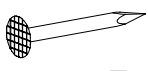

**E - 45 St.**



**A - 14 St.**  
7x50 mm

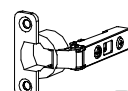

**R2 - 2 St.**

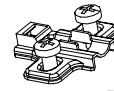

**W2 - 2 St.**

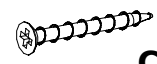

**C - 8 St.**  
3,9x30 mm



**B - 24 St.**  
8x35 mm



**Q - 4 St.**

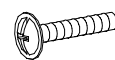

**D - 2 St.**  
4x25 mm

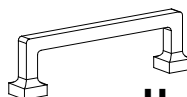

**U - 1 St.**

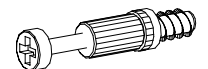

**K - 24 St.**

# ANTICA 17

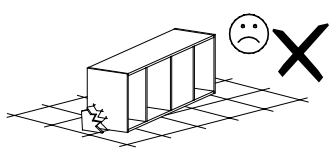
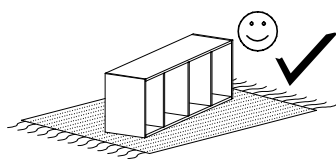
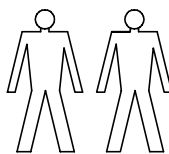

Narzędzia potrzebne do montażu

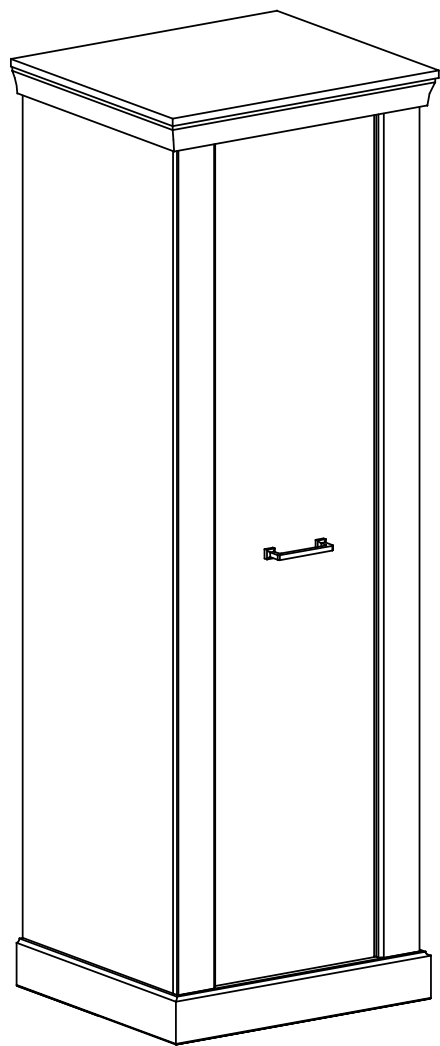
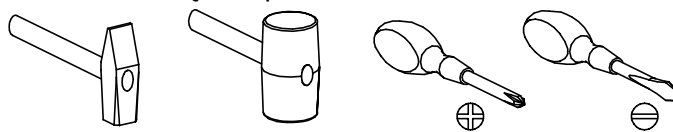

## UWAGA !!!

MONTOWANIE USZKODZONYCH  
ELEMENTÓW POWODUJE UTRATĘ  
GWARANCJI

Nr	D[mm]	S[mm]	G[mm]	Ilość
1	1960	540	16	1
2	1960	540	16	1
3	573	555	16	1
4	573	523	16	2
5	640	100	16	1
6	572	100	16	1
7	572	100	16	1
8	668	580	71	1
9	1892	298	2,5	1
10	1865	100	32	1
11	1865	100	32	1
12	1800	400	16	1
13	605	80	16	1
14	407	55	16	1

W przypadku reklamacji proszę podać numer pakowacza znajdujący się na kartonie.

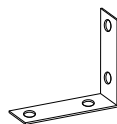

**Y - 2 St.**

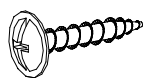

**I - 4 St.**  
3,5x16 mm



**W1 - 2 St.**

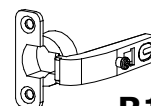

**R1 - 2 St.**



**F - 1 St.**



**R - 2 St.**

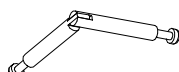

**O - 4 St.**



**Ł - 1 St.**

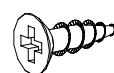

**G - 12 St.**  
3,5x16 mm



**L - 32 St.**

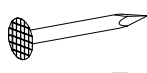

**E - 45 St.**



**A - 14 St.**  
7x50 mm

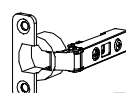

**R2 - 2 St.**

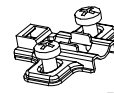

**W2 - 2 St.**

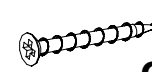

**C - 8 St.**  
3,9x30 mm



**B - 24 St.**  
8x35 mm



**Q - 4 St.**

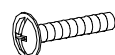

**D - 2 St.**  
4x25 mm



**U - 1 St.**

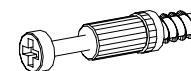

**K - 24 St.**

I

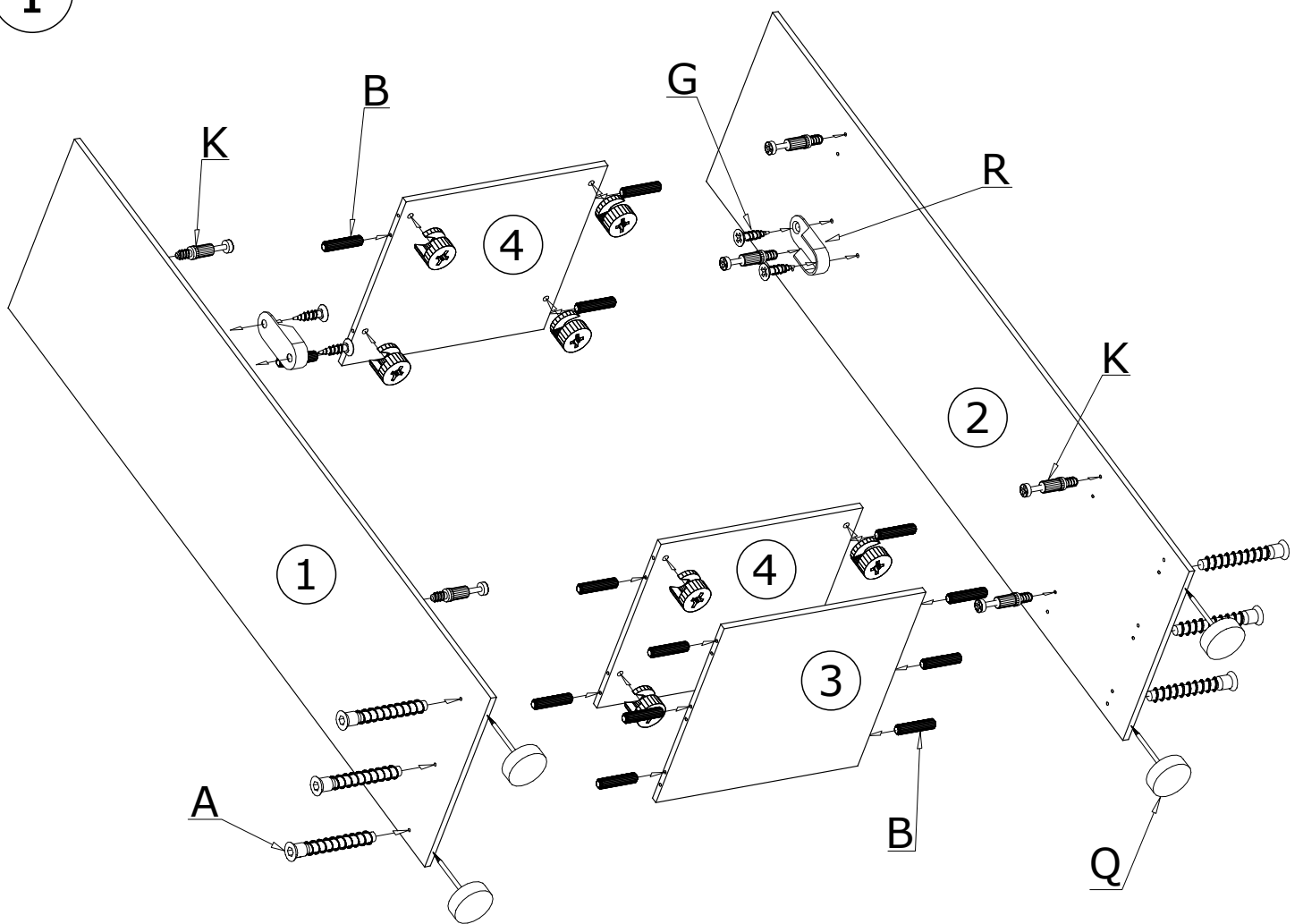

II

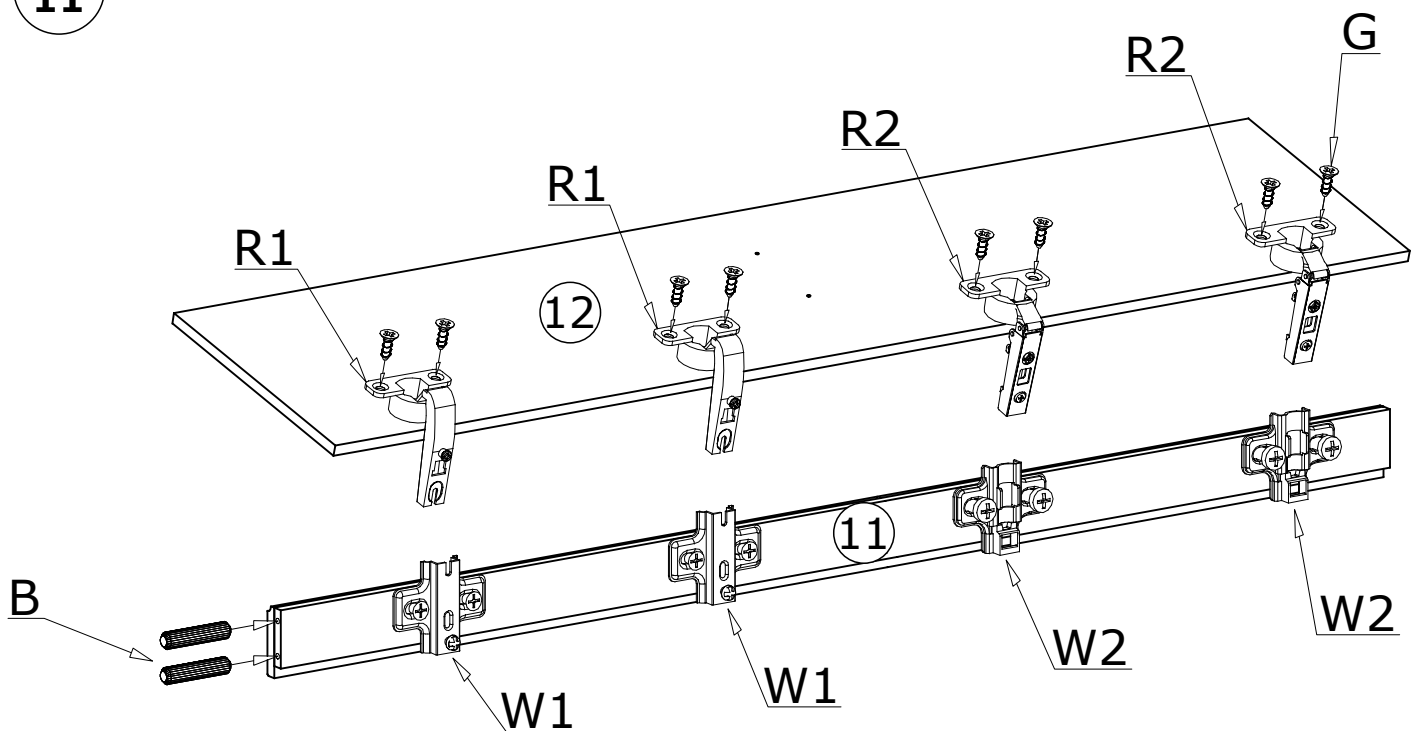

III

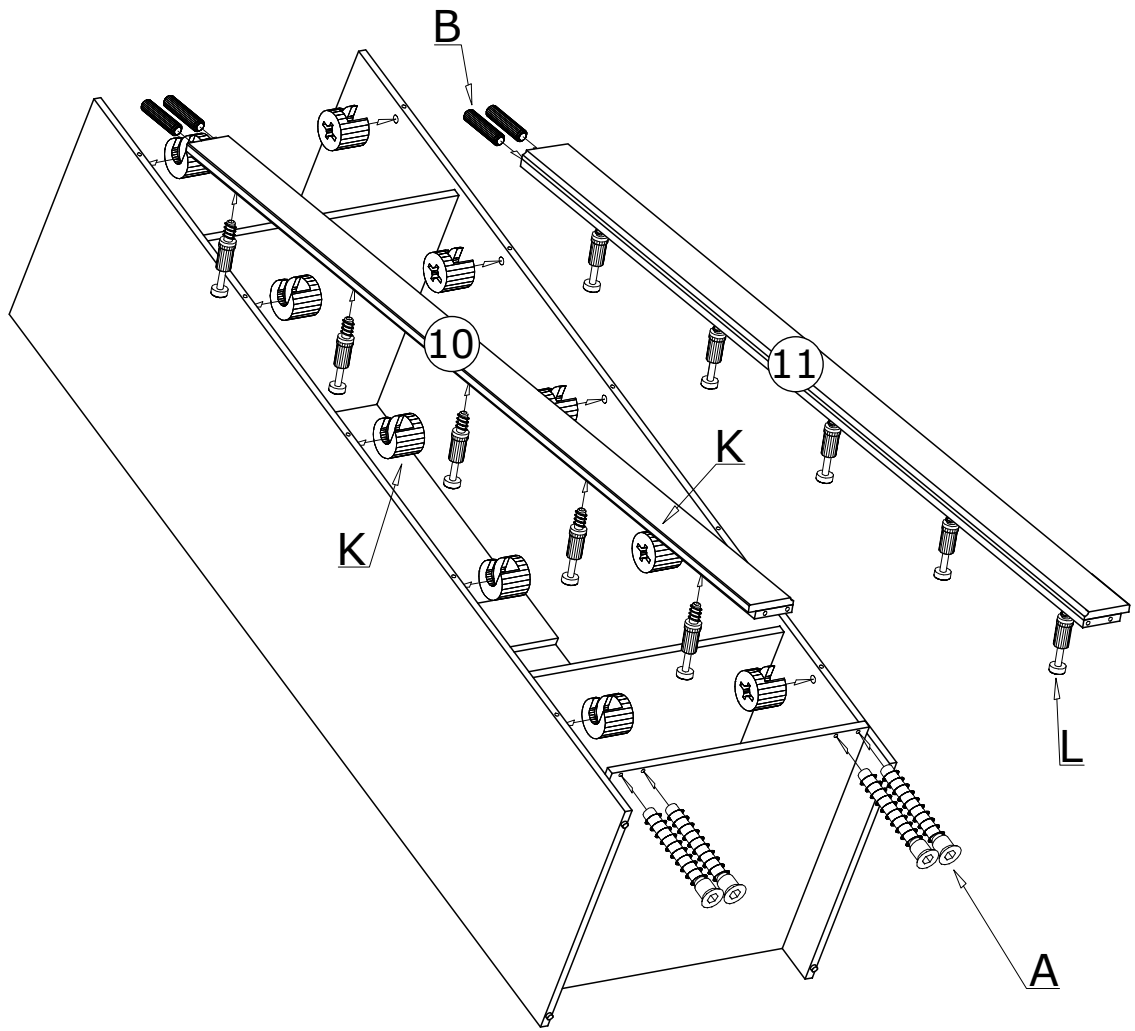

IV

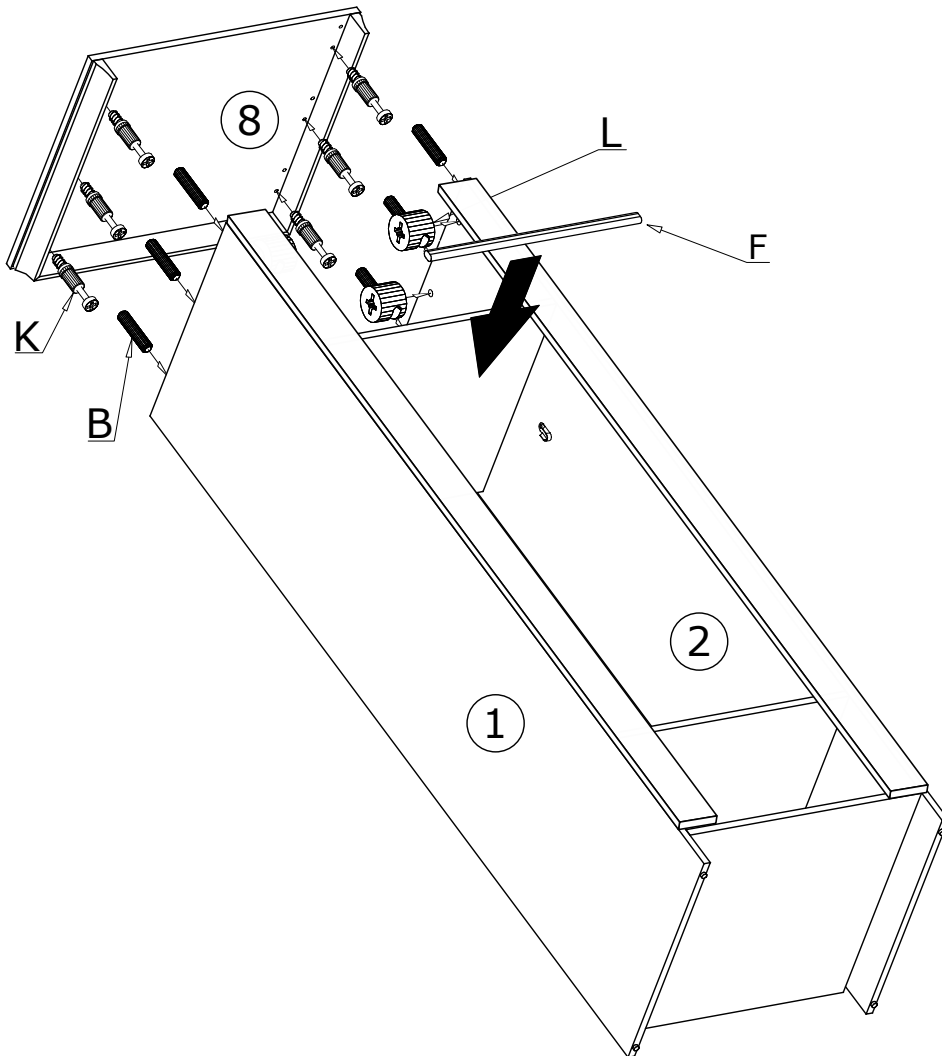

V

45X 

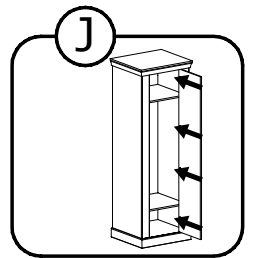
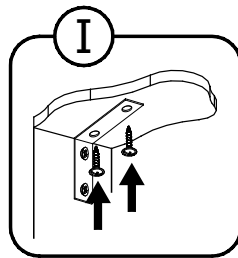
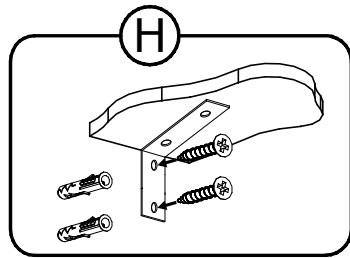
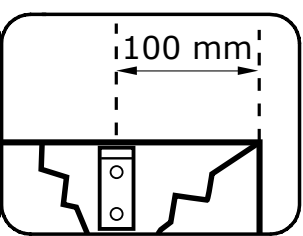
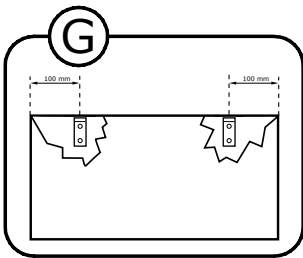
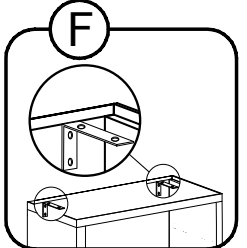
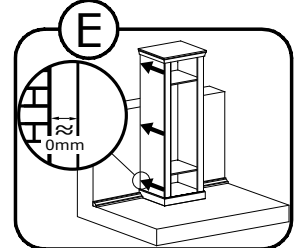
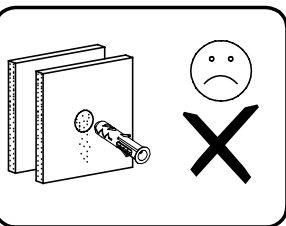
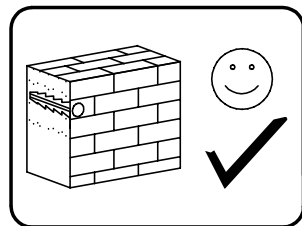
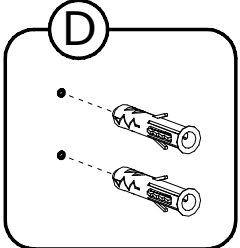
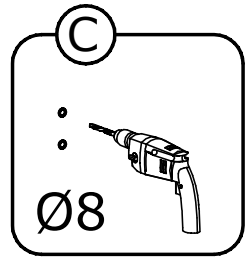
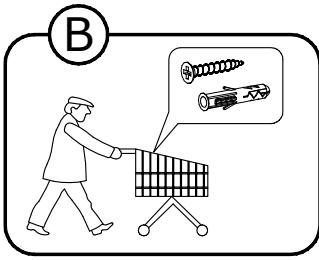
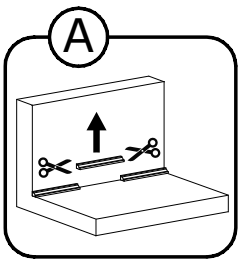
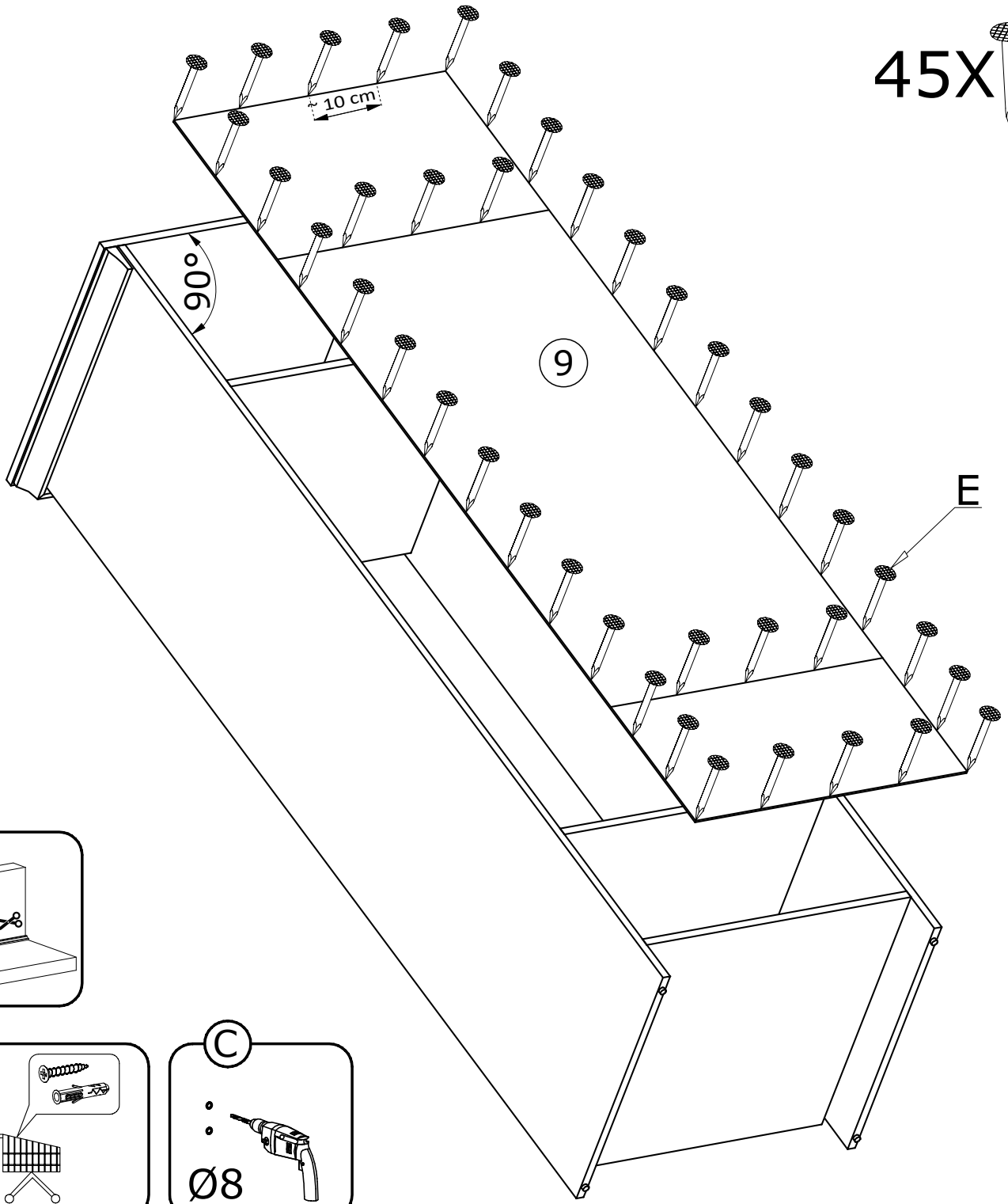

VI

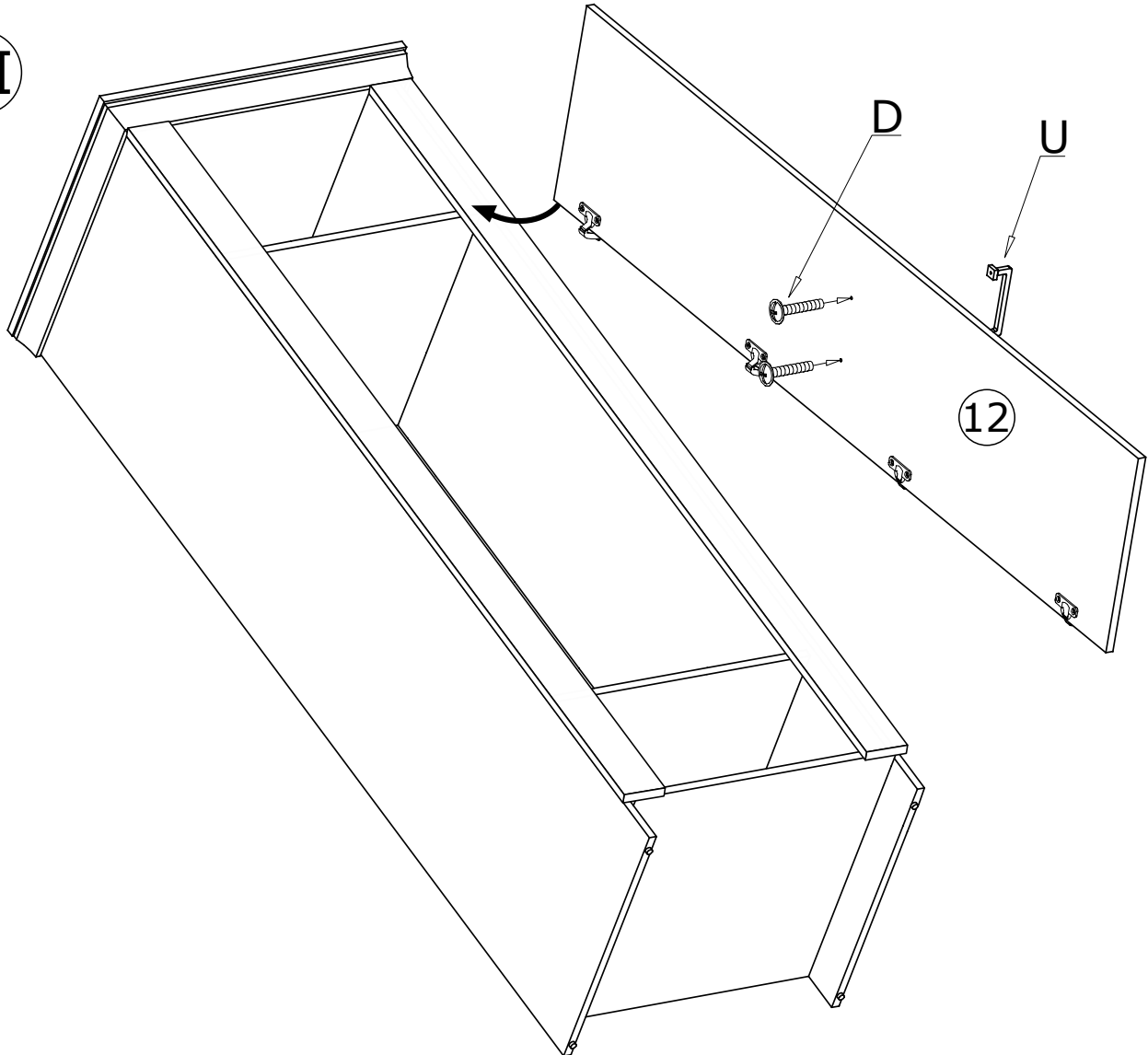

VII

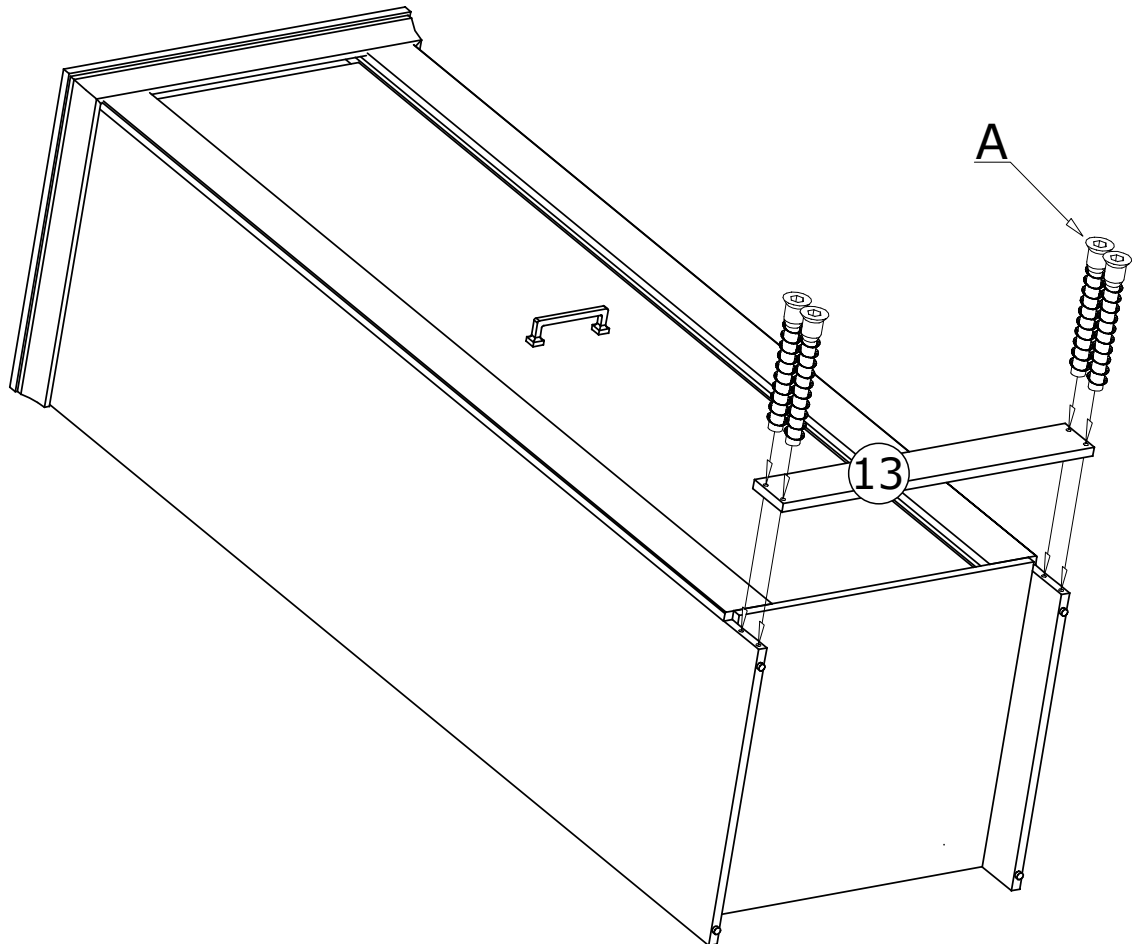

VIII

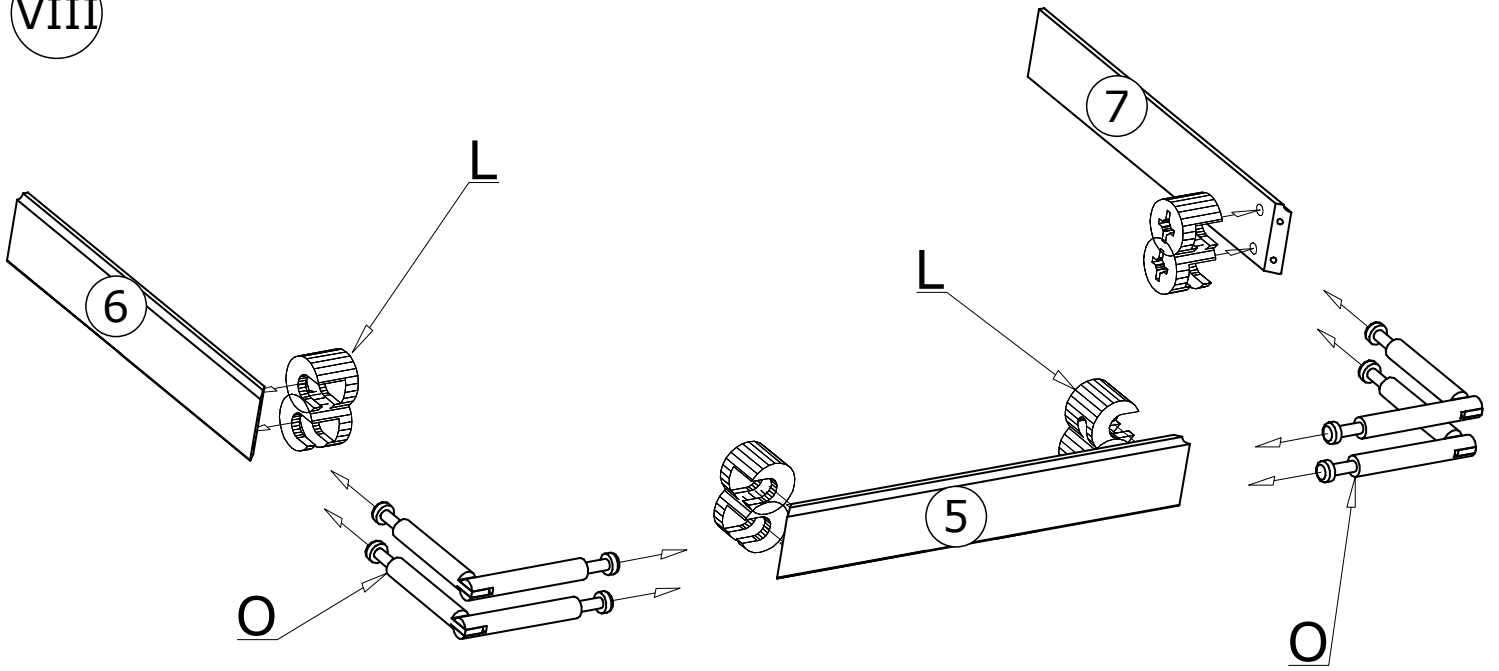

IX

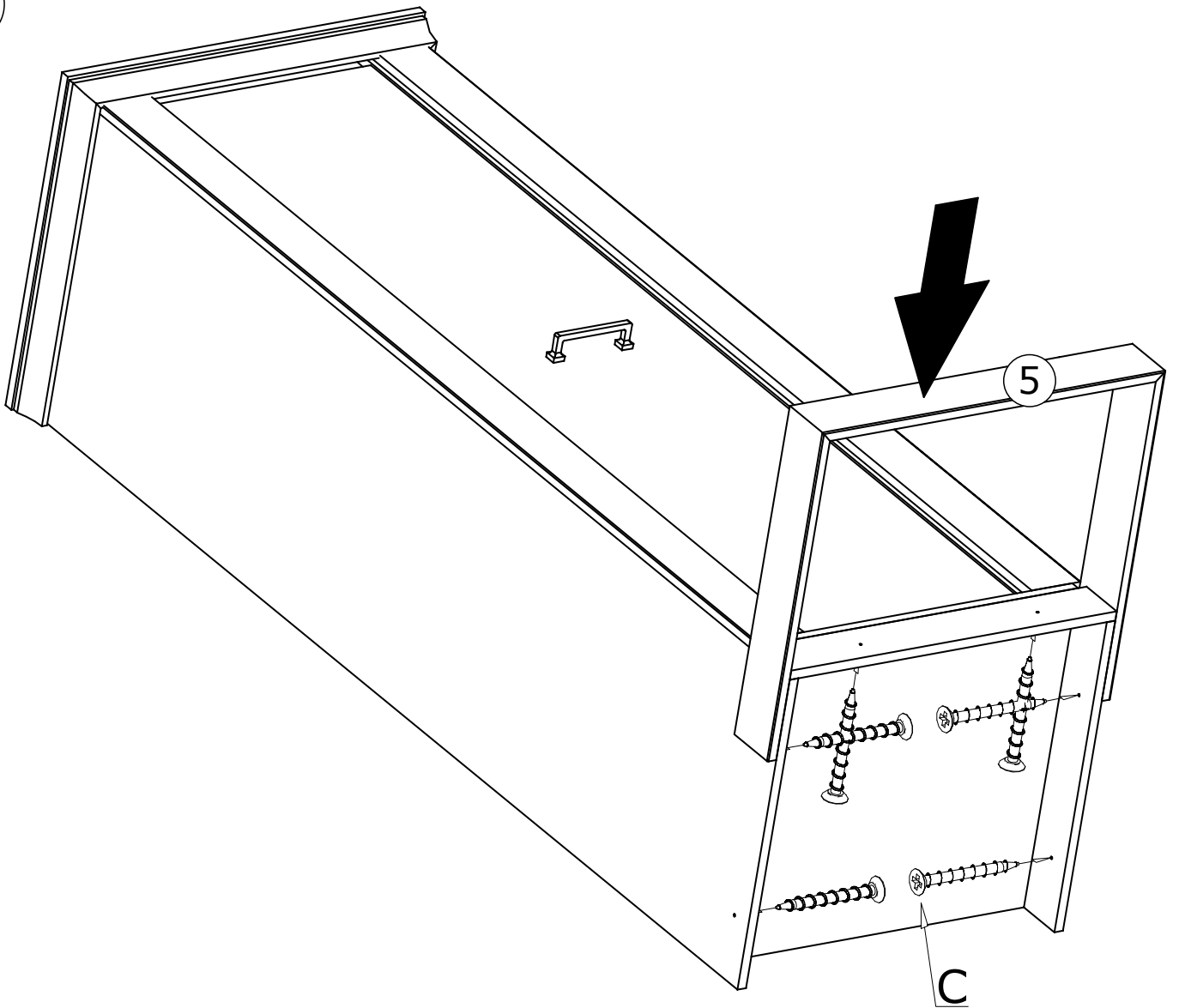

X

