

NATURAL 3

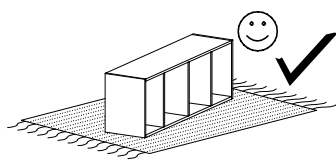

Narzędzia potrzebne do montażu

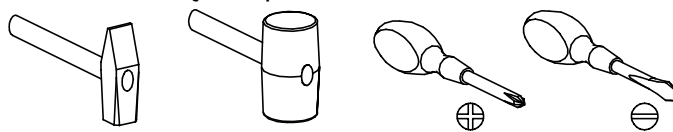

UWAGA !!!

MONTOWANIE USZKODZONYCH
ELEMENTÓW POWODUJE UTRATĘ
GWARANCJI

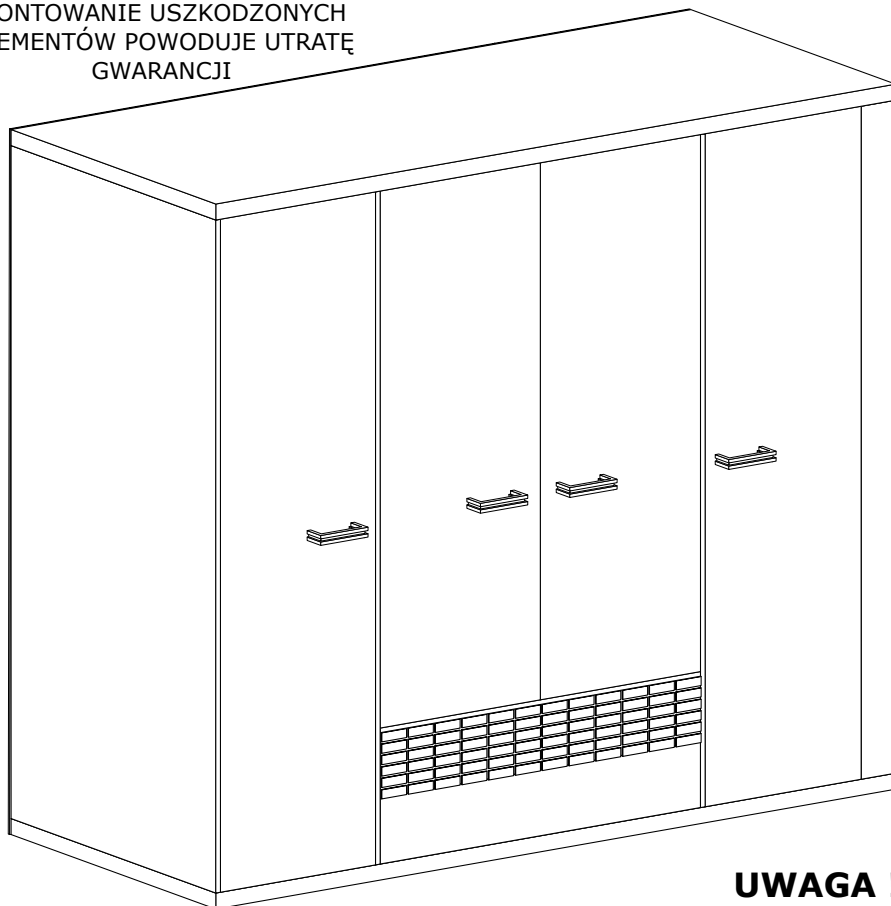

Nr	D[mm]	S[mm]	G[mm]	Ilość
1	1900	576	16	1
2	1900	560	16	1
3	1955	577	48	1
4	1955	577	48	1
5	1900	576	16	2
6	900	560	16	1
7	900	576	16	1
8	1900	100	16	1
9	560	536	16	2
10	560	450	16	2
11	1950	472	2,5	1
12	1950	912	2,5	1
13	1950	555	2,5	1
14	500	165	16	4
15	842	165	16	2
16	892	190	35	1
17	892	190	32	1
18	870	495	2,5	2
19	1894	445	16	2
20	1480	445	16	2

UWAGA !!!

Mebel zawiera elementy drewniane

W przypadku reklamacji proszę podać numer pakowacza znajdujący się na kartonie.

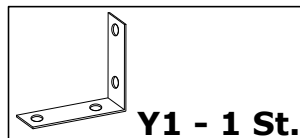

Y1 - 1 St.

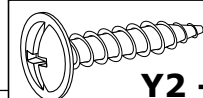

Y2 - 2 St.

4x25 mm



A - 4 St.

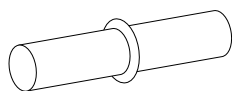

B - 16 St.

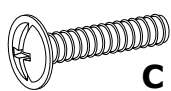

C - 8 St.

4x25 mm

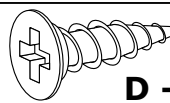

D - 72 St.

3,5x16 mm

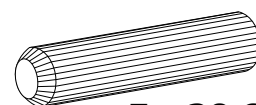

E - 20 St.

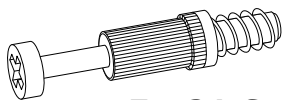

F - 21 St.

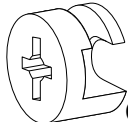

G - 21 St.



H - 16 St.



I - 100 St.

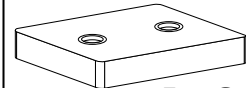

J - 8 St.

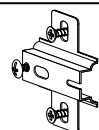

K - 10 St.

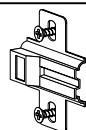

L - 4 St.

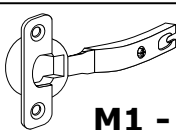

M1 - 3 St.

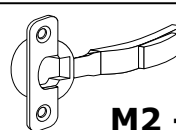

M2 - 1 St.

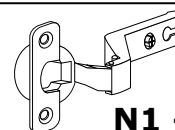

N1 - 7 St.

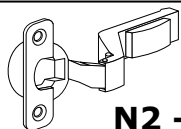

N2 - 3 St.

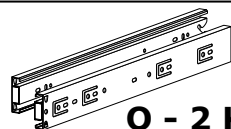

O - 2 Kpl.

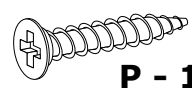

P - 16 St.

3,5x25 mm

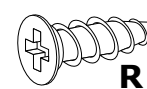

R - 16 St.

5x13 mm

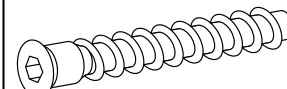

S - 8 St.

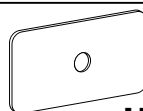

U - 32 St.

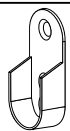

T - 6 St.



W - 75 St.

3x30 mm

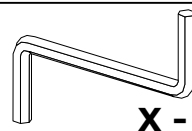

X - 1 St.

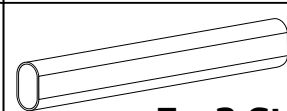

Z - 3 St.

I

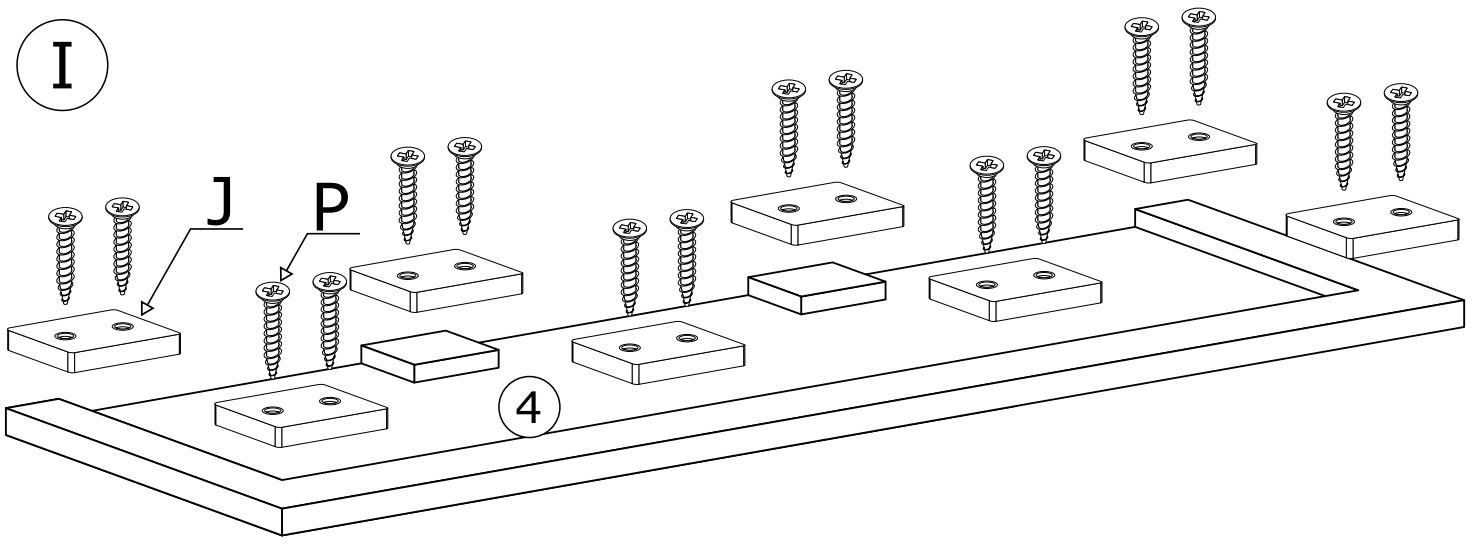

II

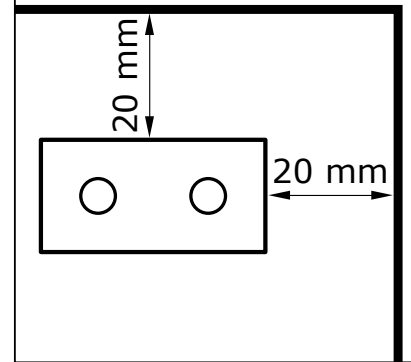
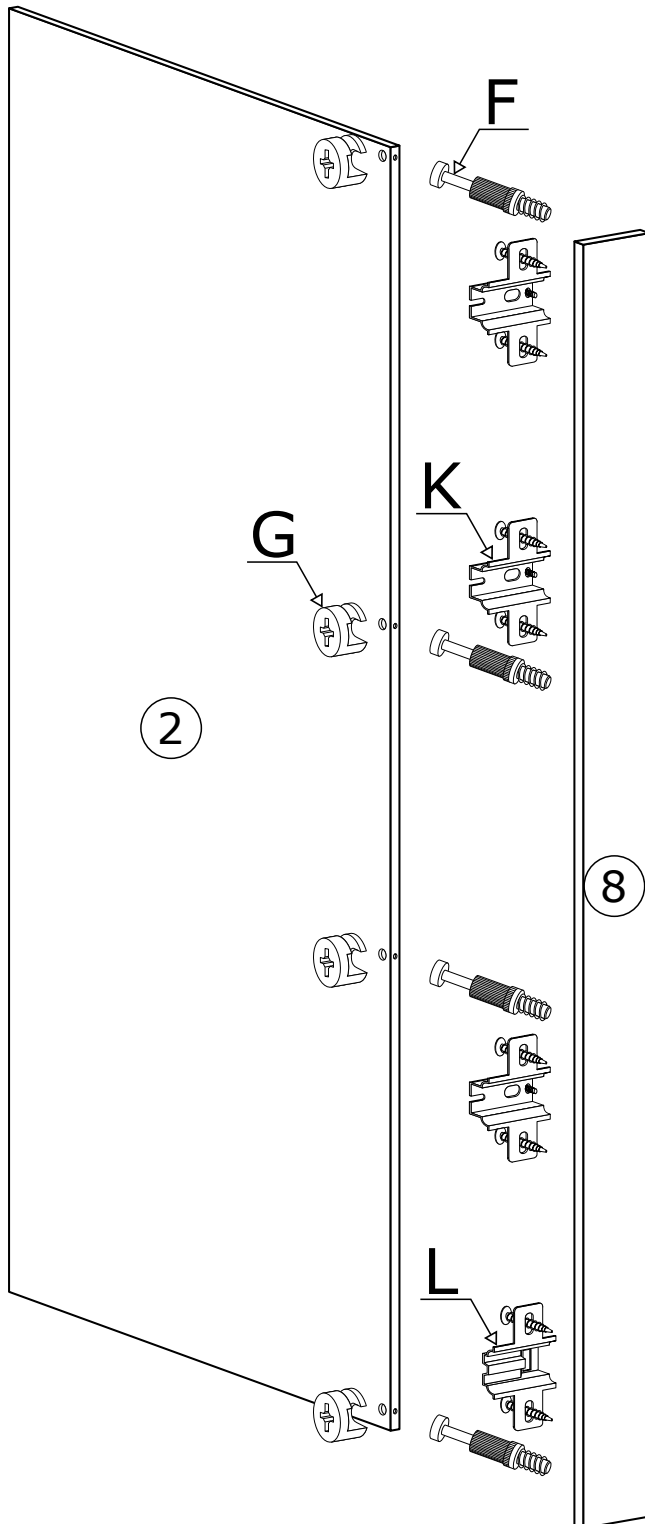

III

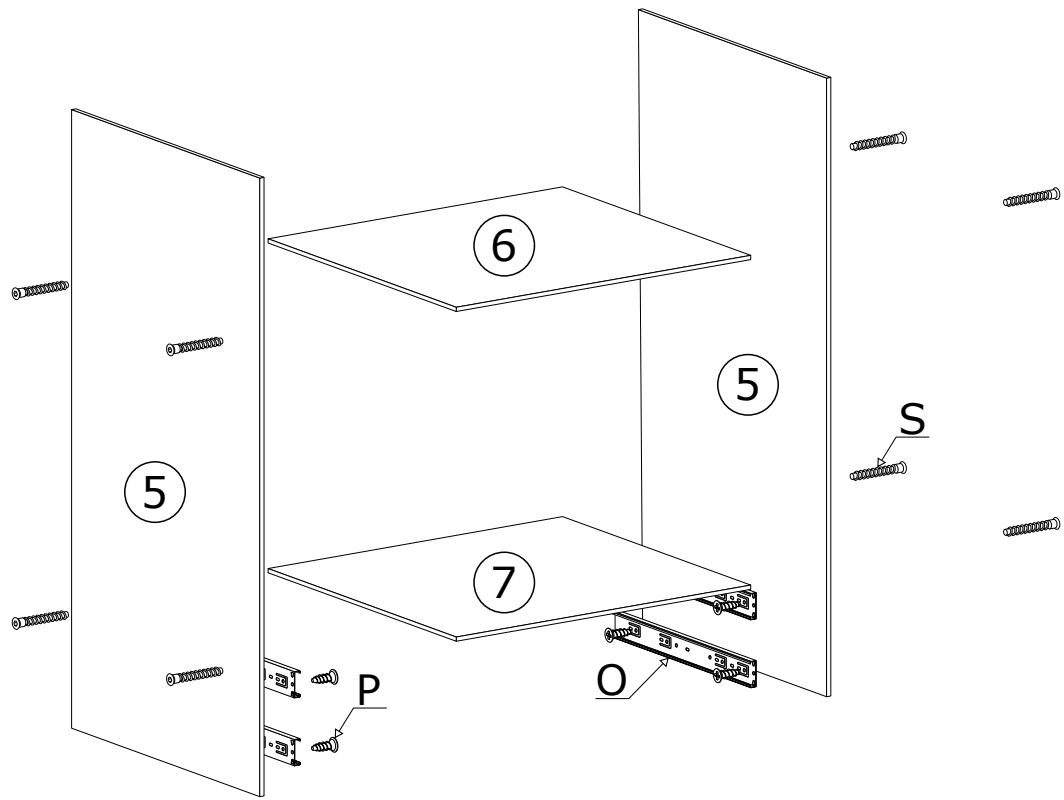

IV

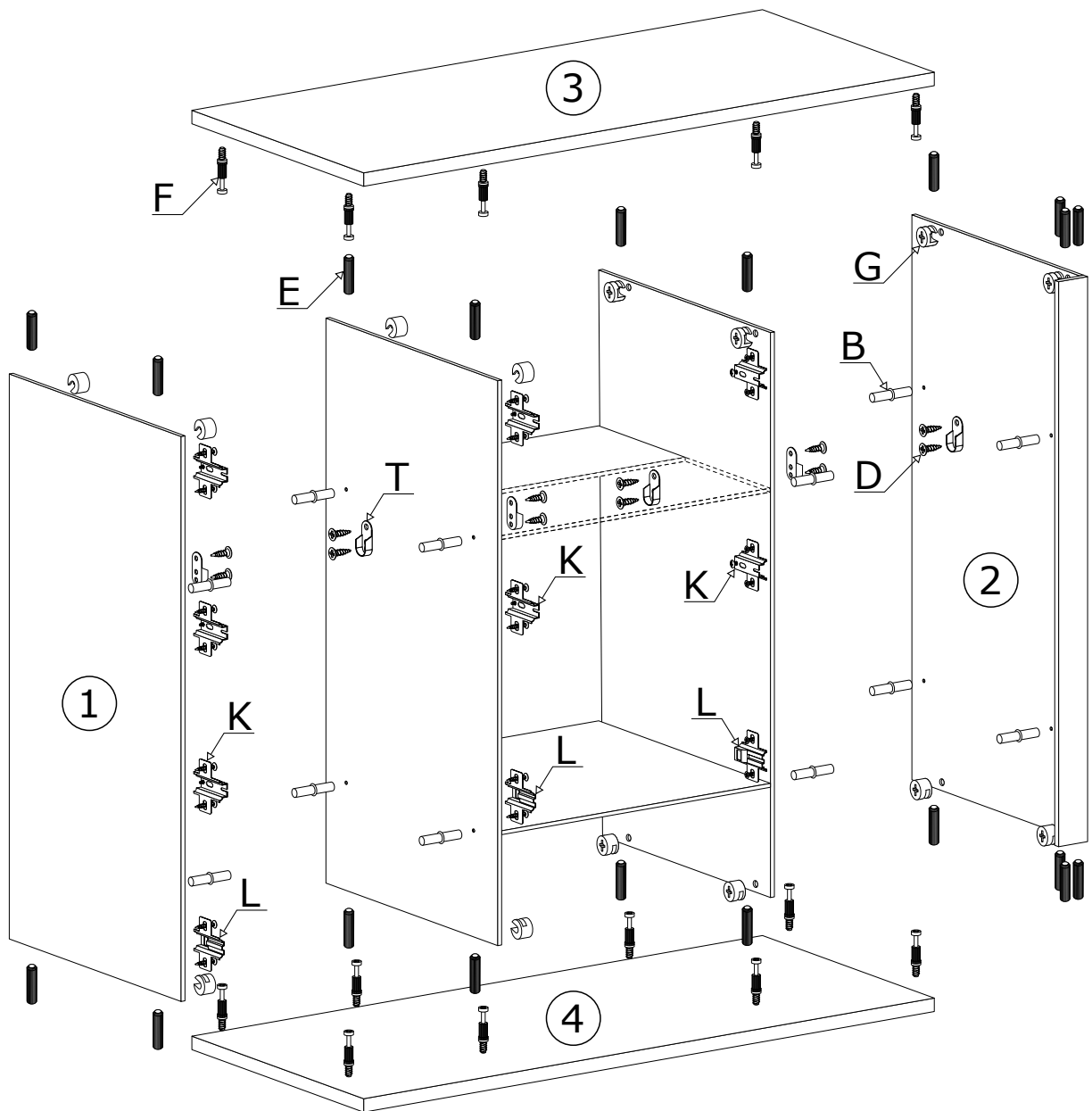

V

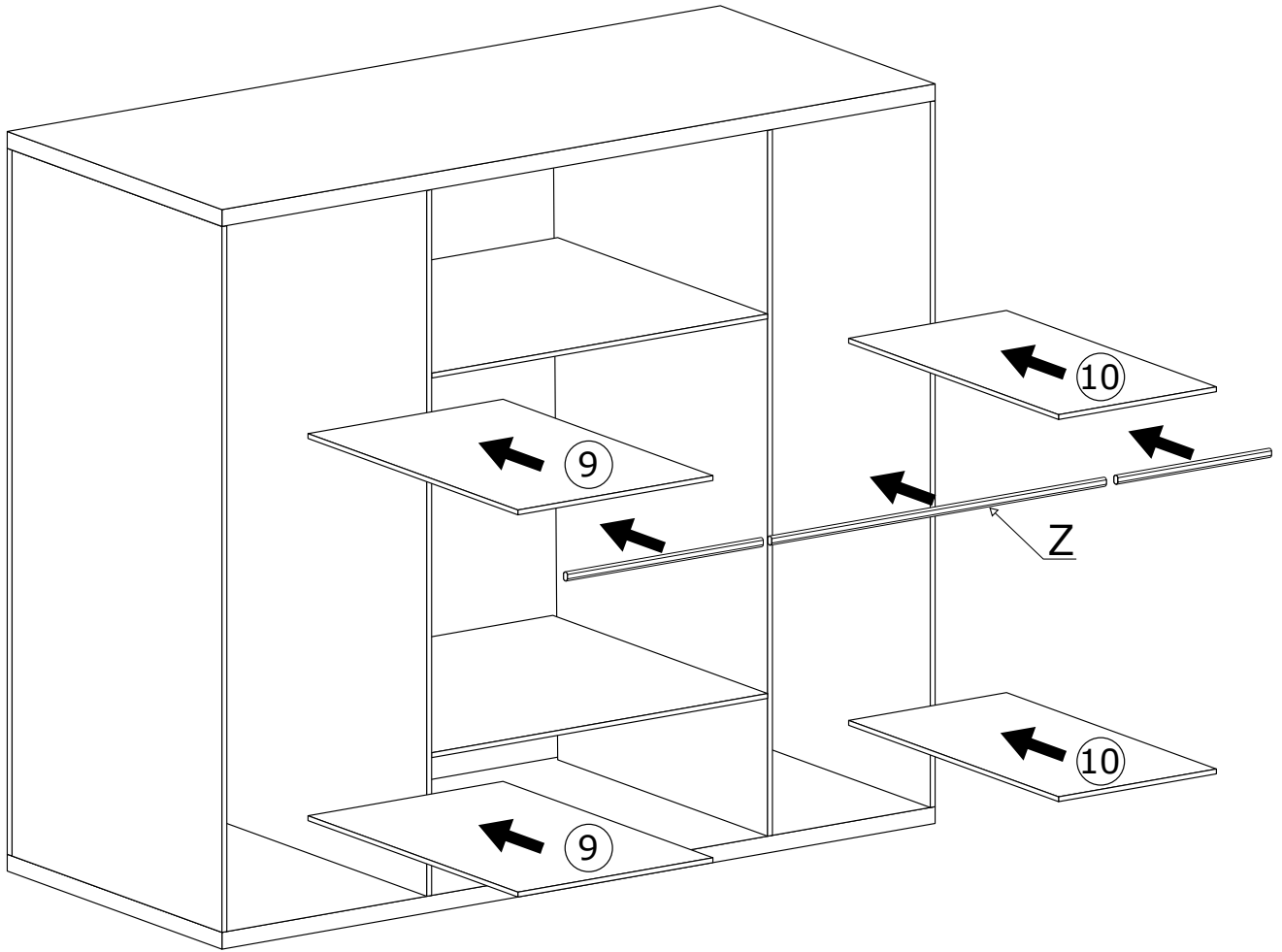

VI

x100

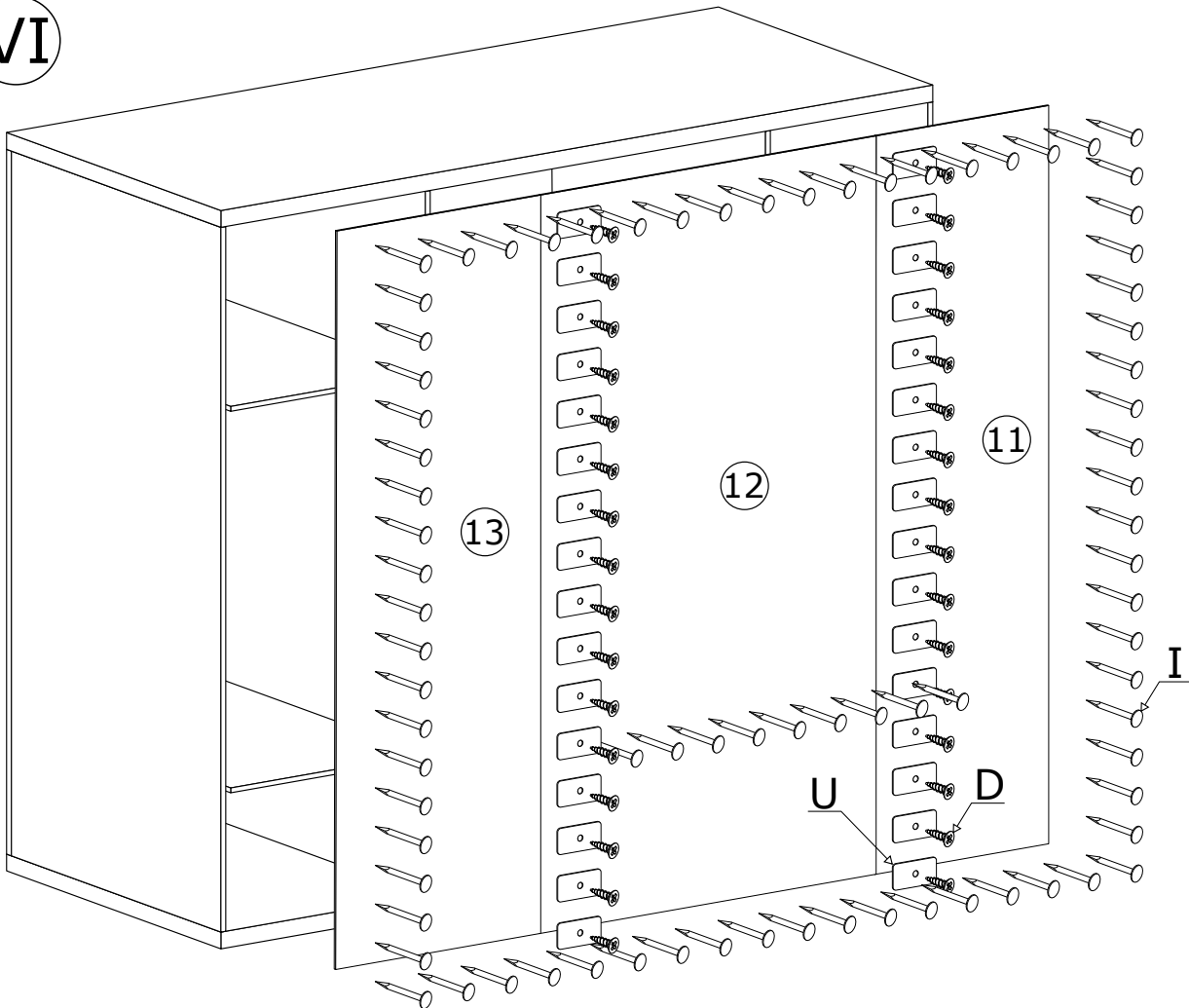

VII

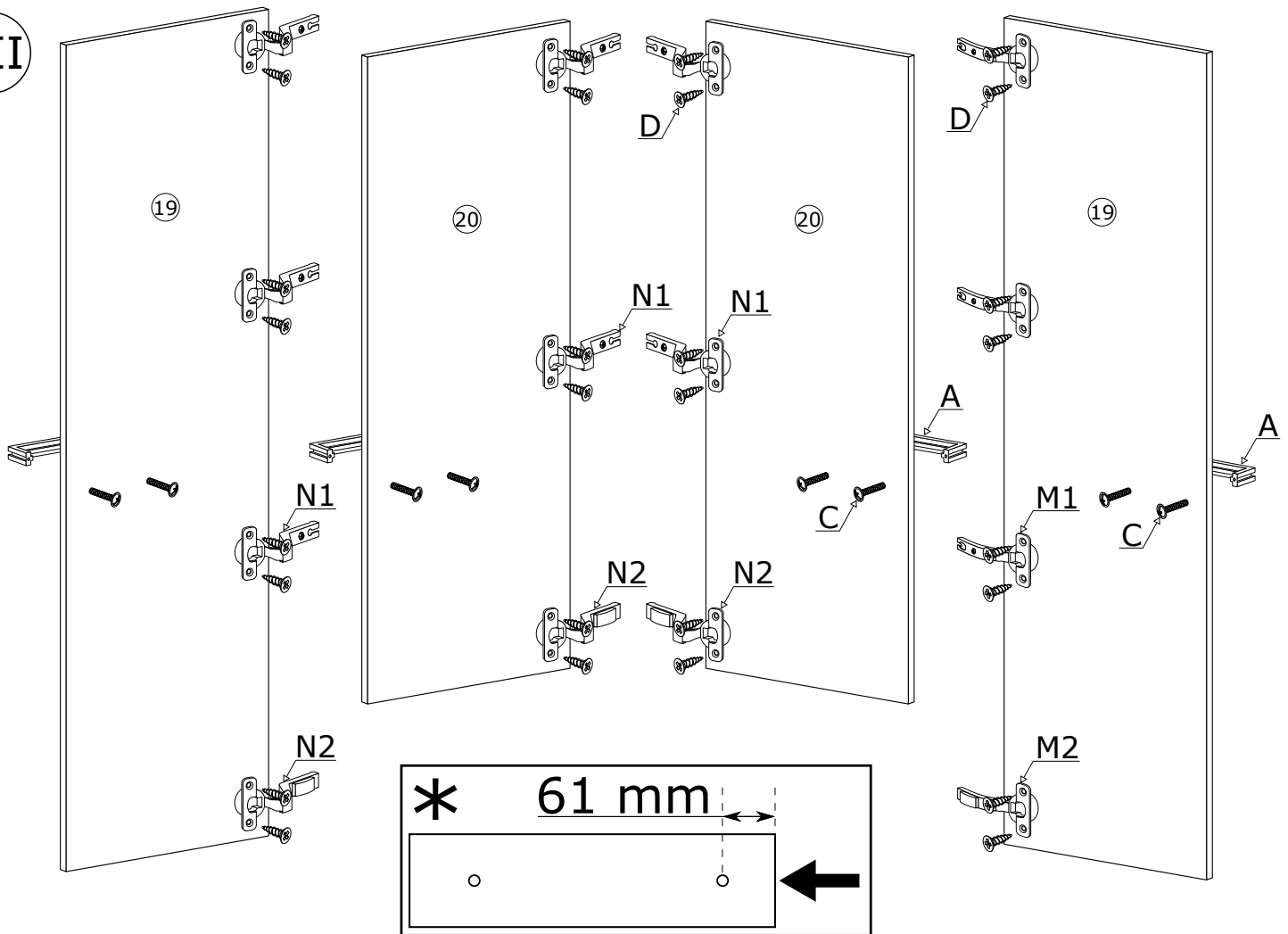

VIII

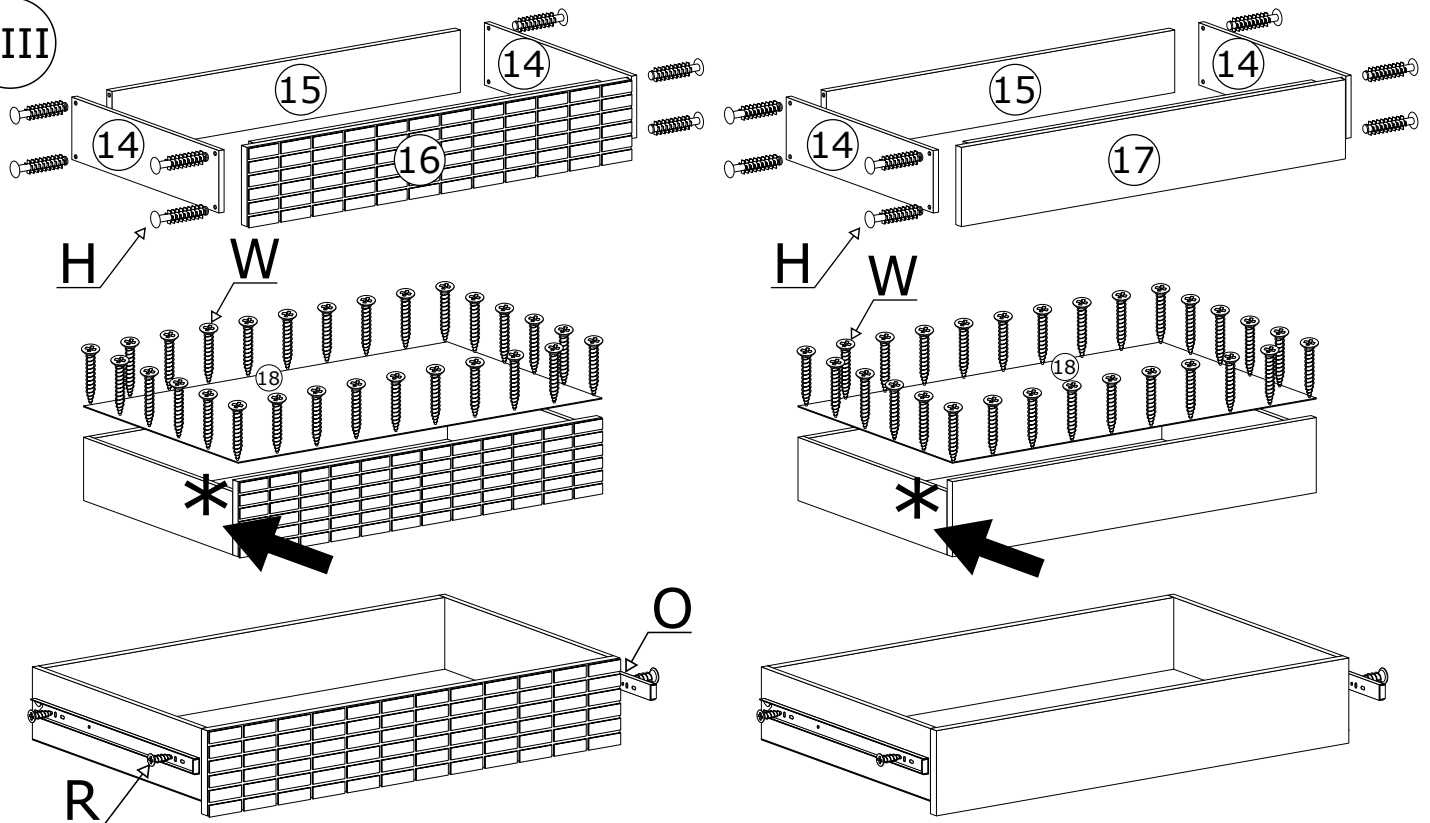

ELEMENT OZDOBNY WYKONANY RĘCZNIE Z PRAWDZIWEGO DREWNA. ODCIĘN DREWNA I OKŁAD SŁOJI MOGĄ NIEZNACZNIE ODBIEGAĆ OD PREZENTOWANYCH NA ZDJĘCIACH KATALOGOWYCH.

IX

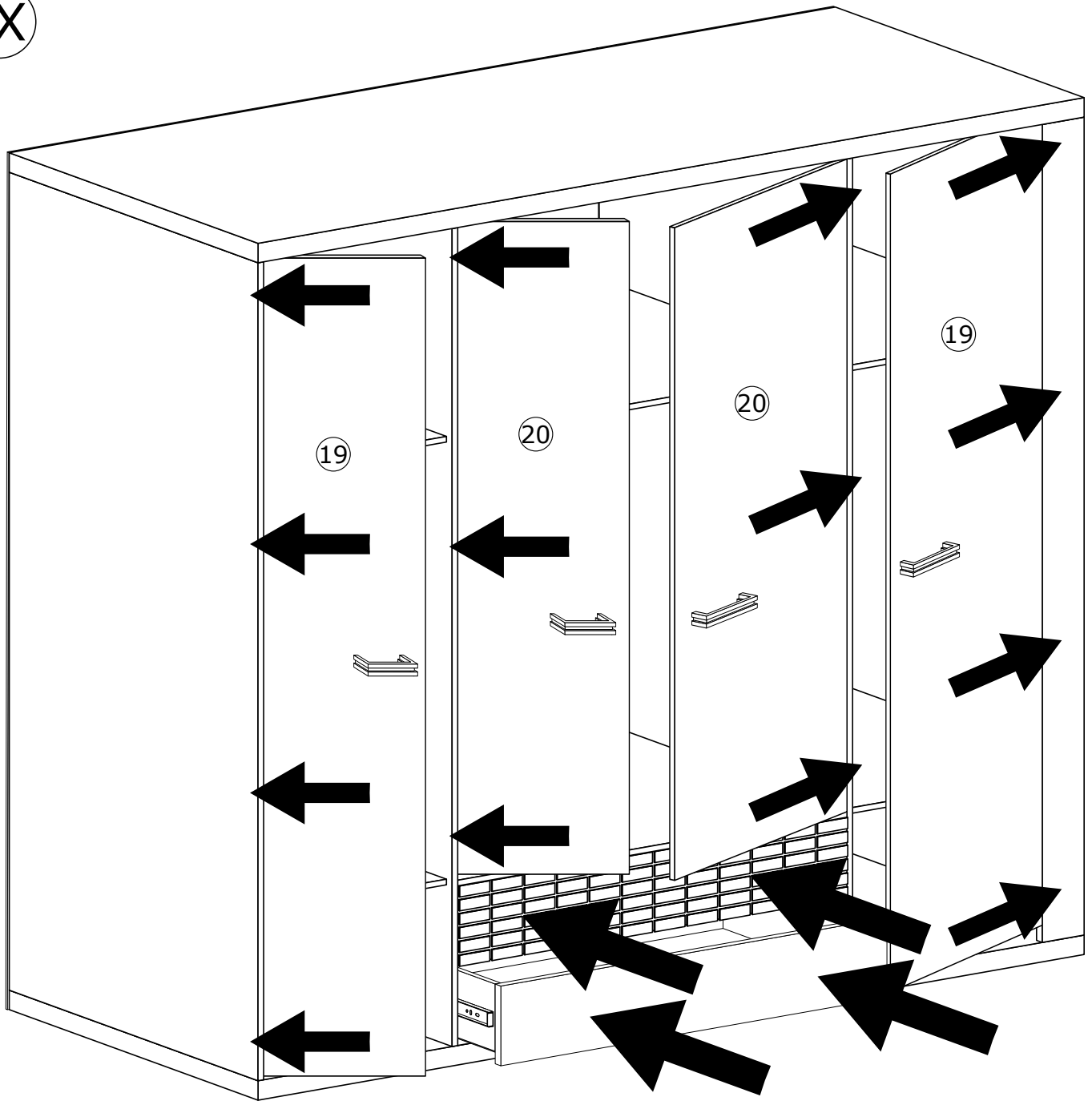

X

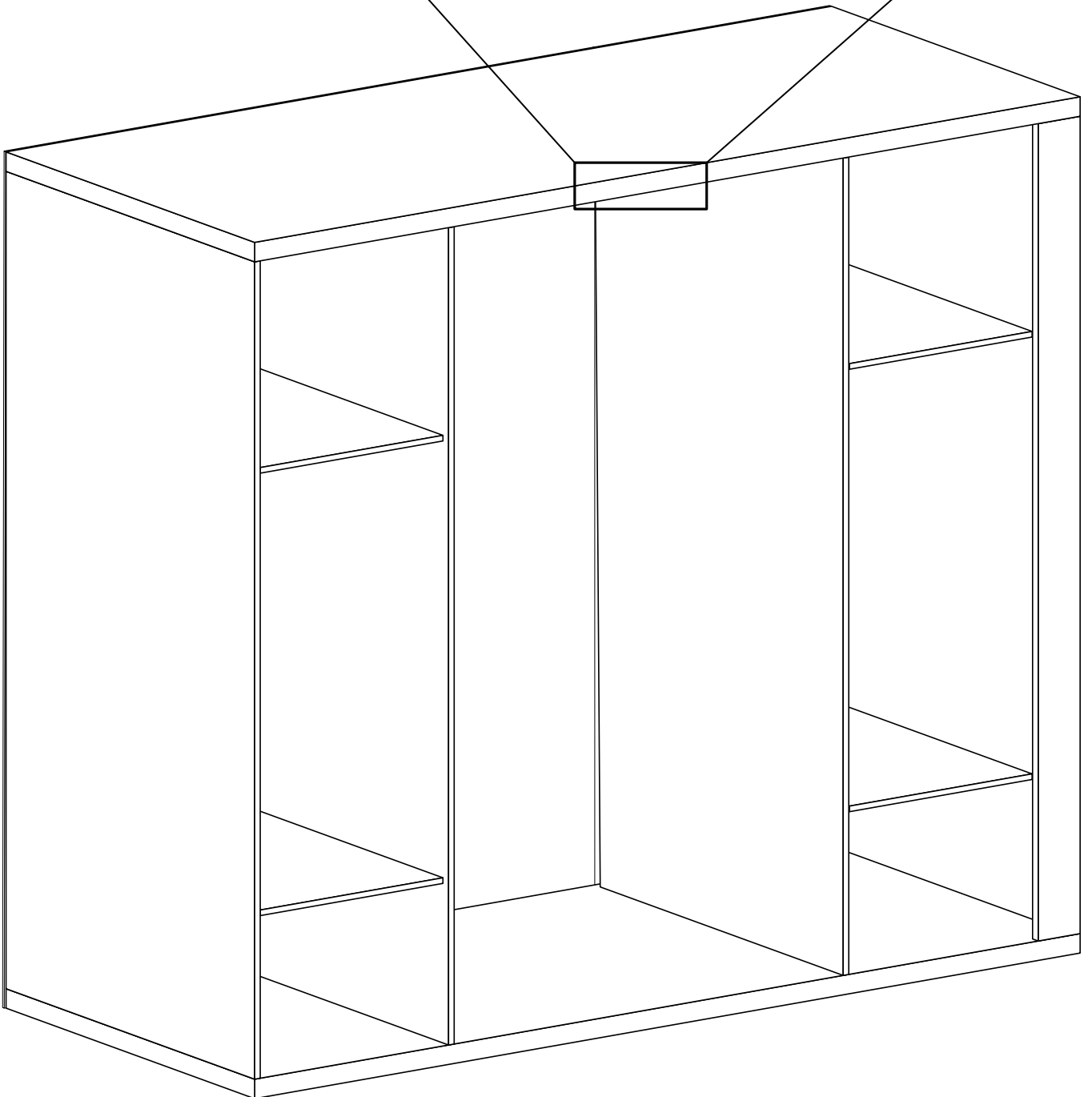
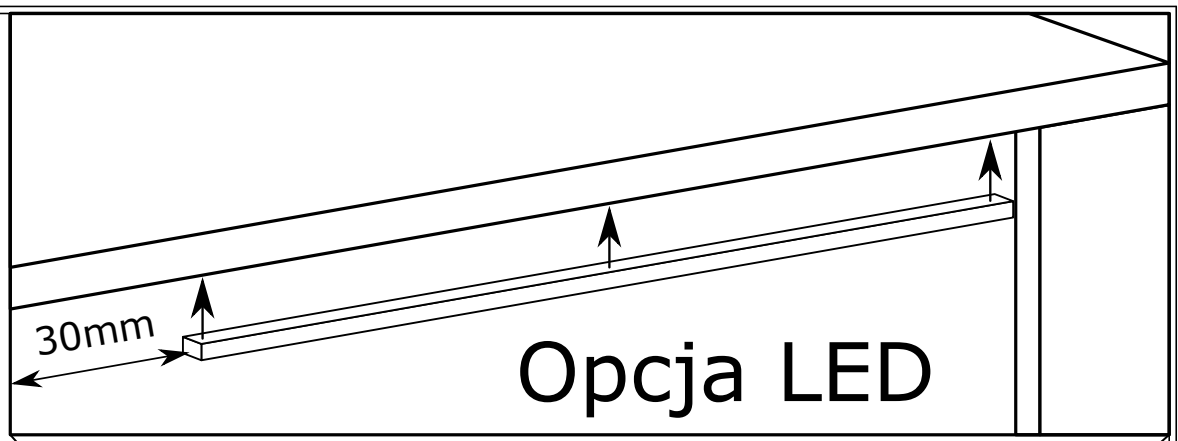

MONTAŻ/DEMONTAŻ PROWADNIC

1

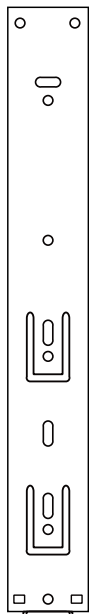

2

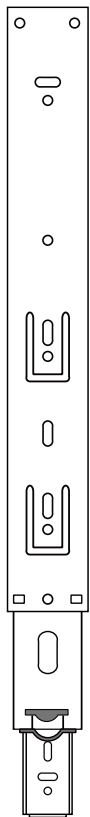

3

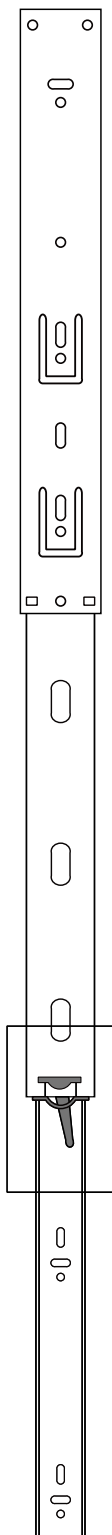

4

