

INDIANAPOLIS 22

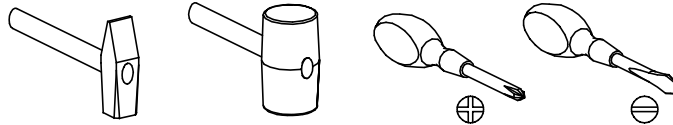

Narzędzia potrzebne do montażu



UWAGA !!!

MONTOWANIE USZKODZONYCH
ELEMENTÓW POWODUJE UTRATĘ
GWARANCJI

UWAGA !!!

Mebel zawiera
elementy drewniane

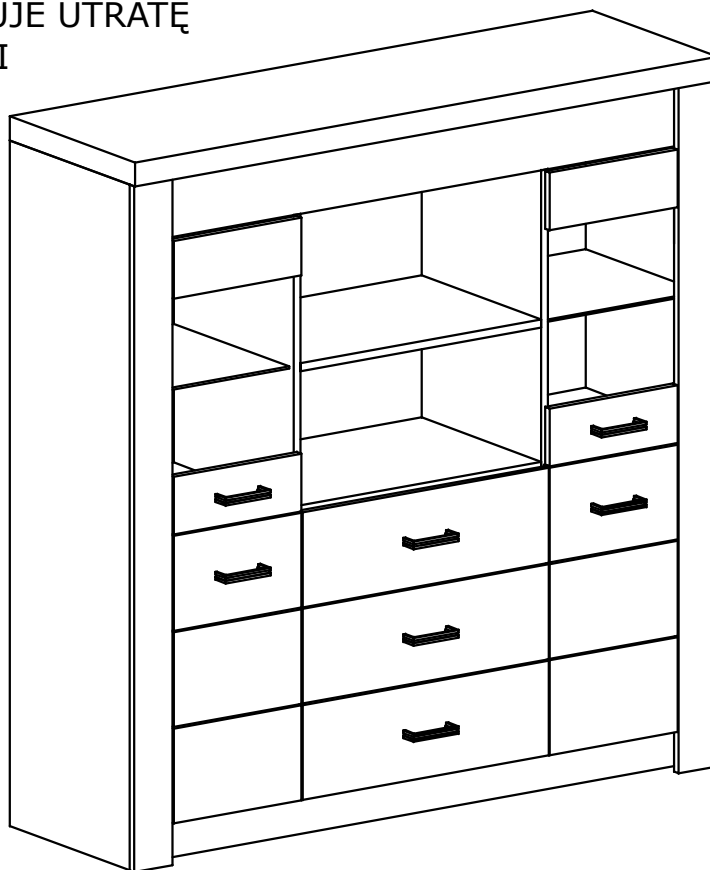

Nr	D[mm]	S[mm]	G[mm]	Ilość
1	618	403	16	1
2	1265	403	16	1
3	1265	403	16	1
4	1337	403	16	1
5	1337	80	16	1
6	1337	123	16	1
7	1361	403	16	1
8	1361	403	16	1
9	1361	80	16	1
10	1361	80	16	1
11	1370	422	48	1
12	635	190	16	3
13	350	150	16	3
14	350	150	16	3
15	560	150	16	3
16	590	355	2,5	3
17	1320	363	2,5	2
18	1320	632	2,5	1
19	344	380	16	2
20	280	120	16	1
21	280	120	16	1
22	385	275	4	2
23	280	120	16	1
24	280	120	16	1
25	344	380	4	2
26	618	380	16	1
27	344	380	16	2
28	578	380	16	1
29	578	380	16	1

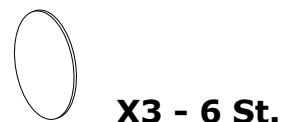
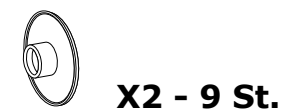
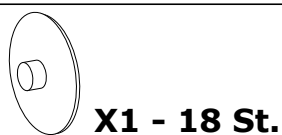

W przypadku reklamacji proszę podać numer pakowacza znajdujący się na kartonie.

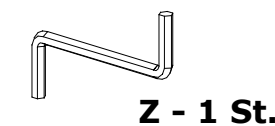
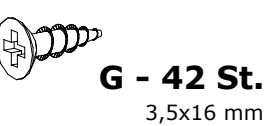
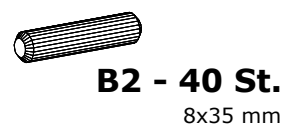
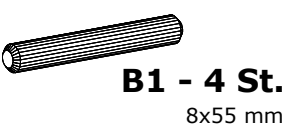
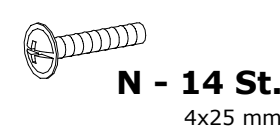
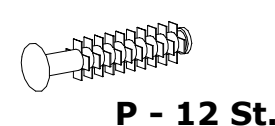
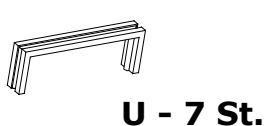
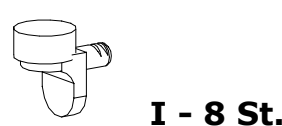
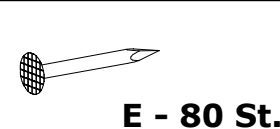
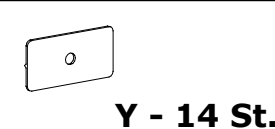
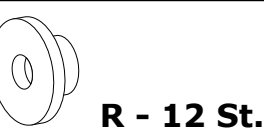
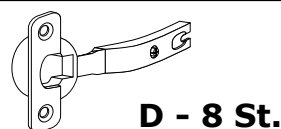
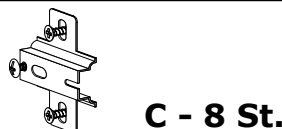
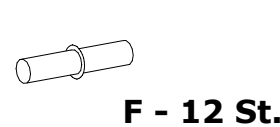
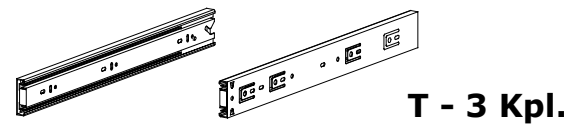
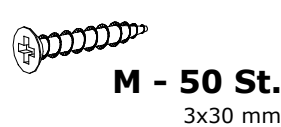
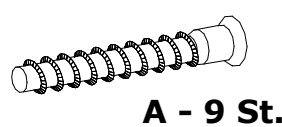
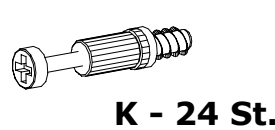
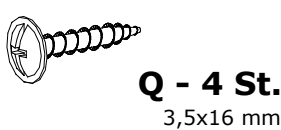
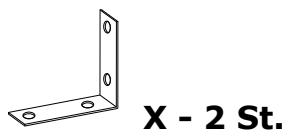

I

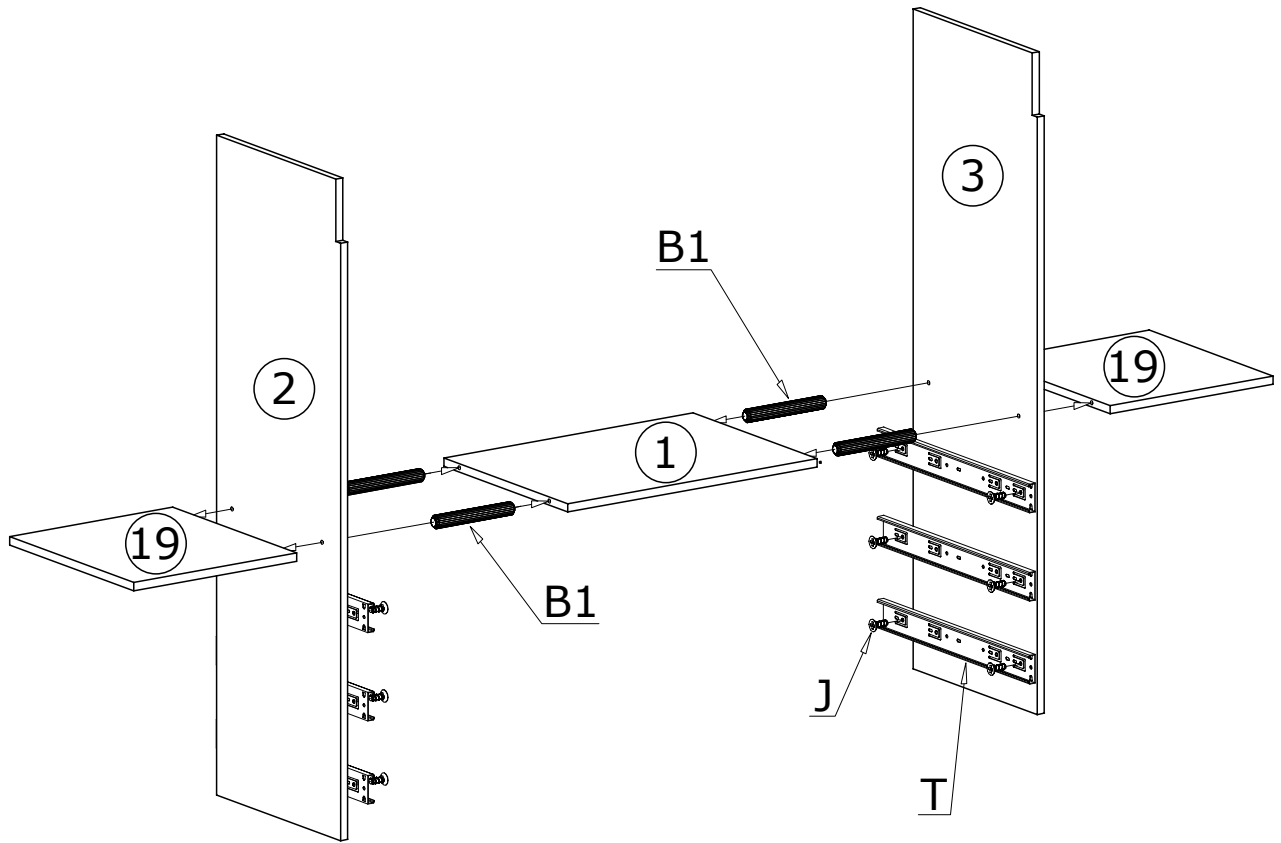

II

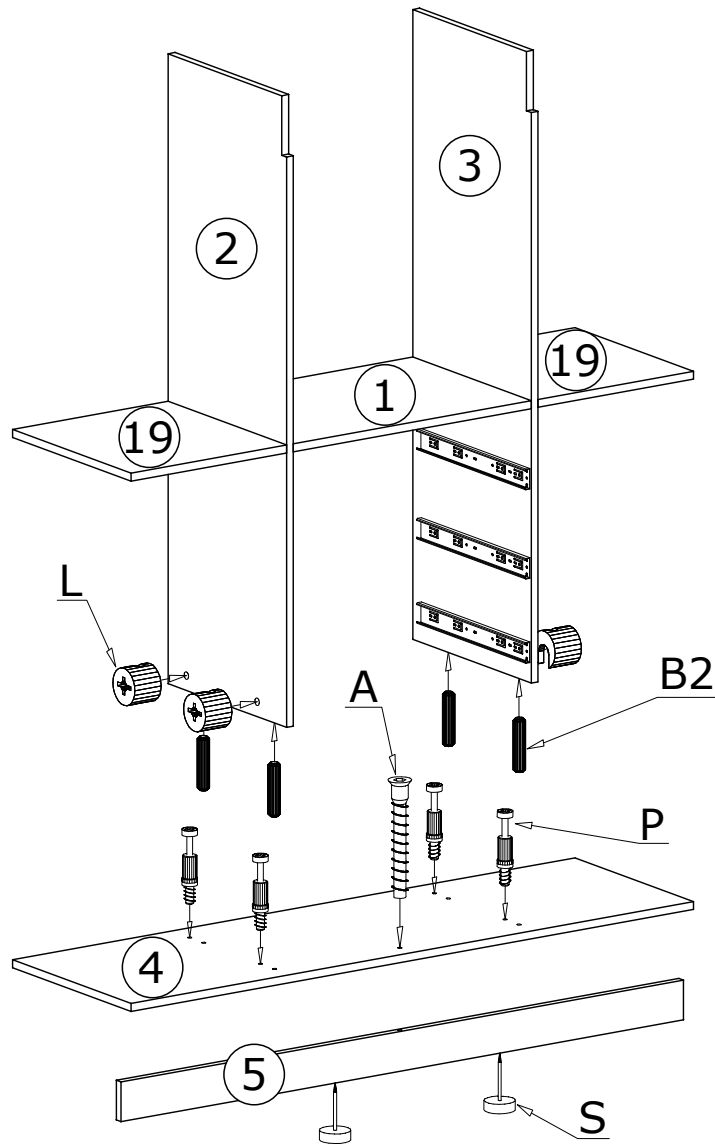

III

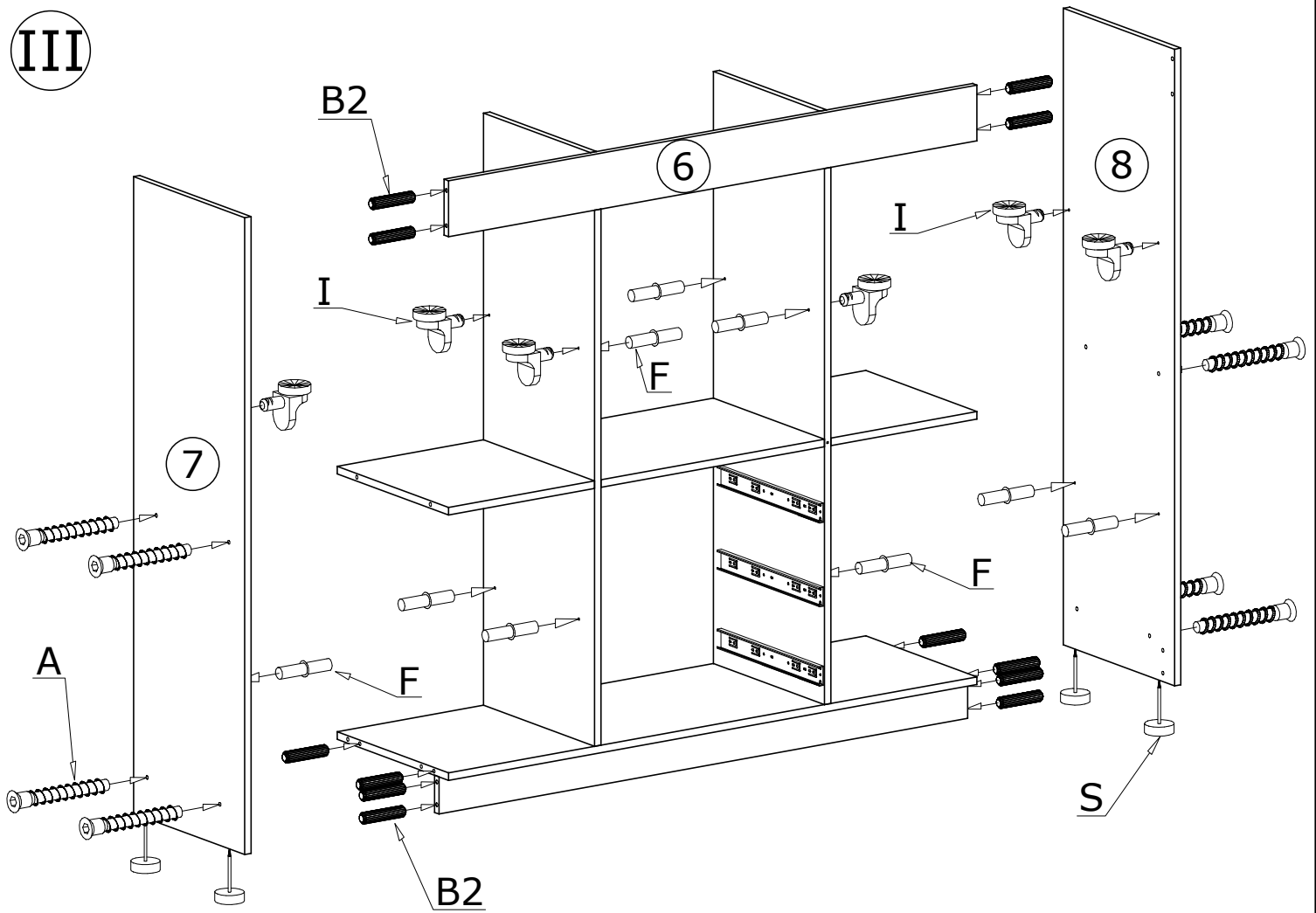

IV

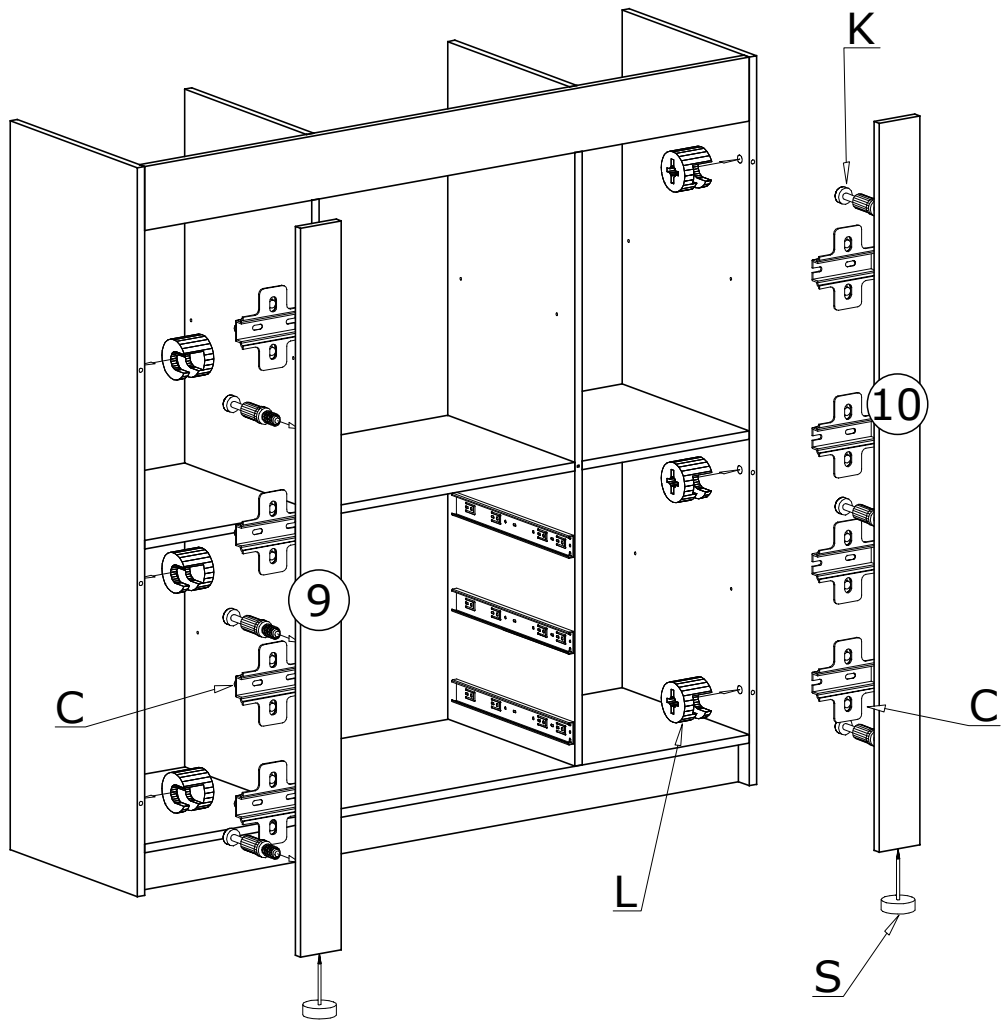

V

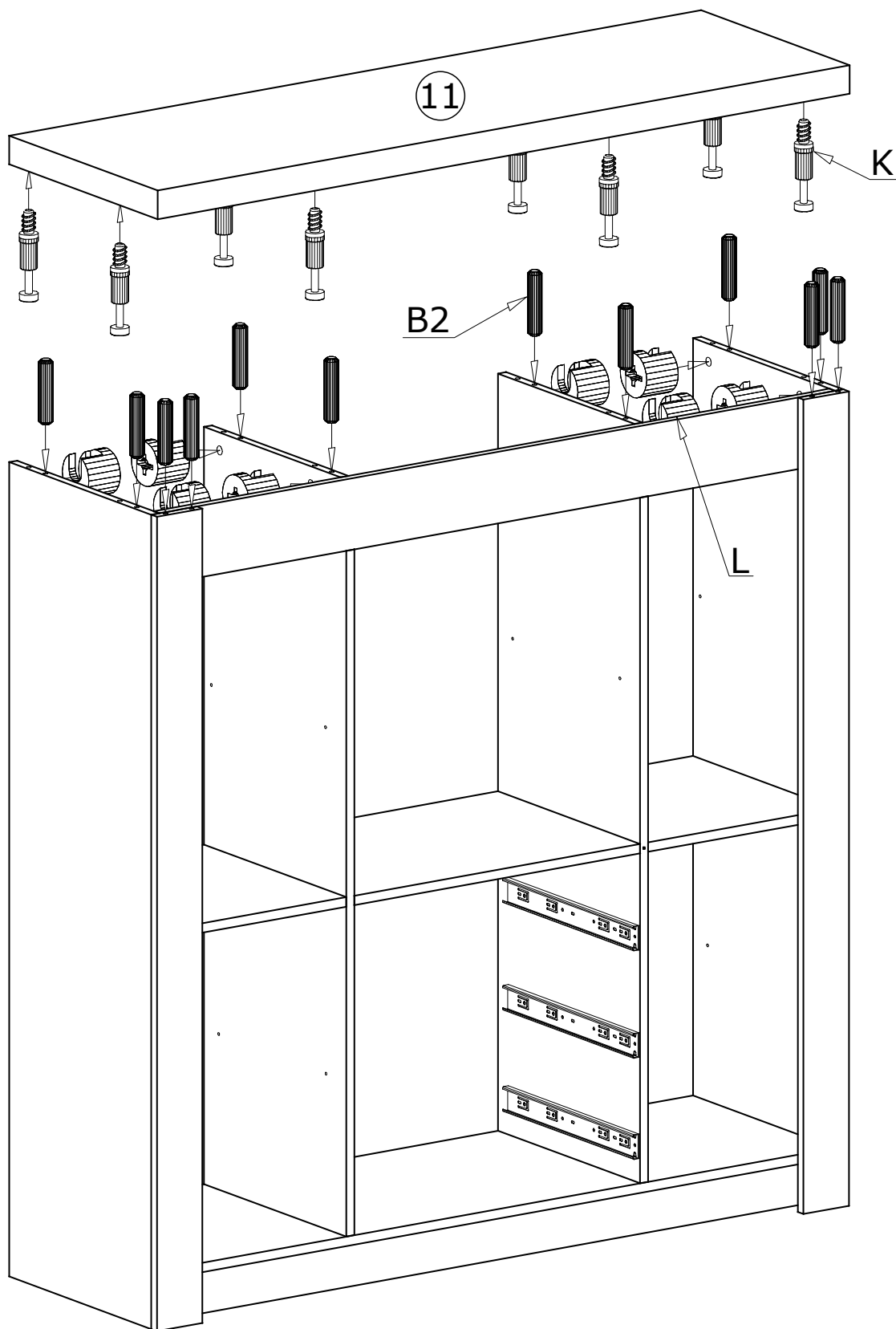

Meble zawierają elementy drewniane, których barwa i układ słojów są uzależnione od wielu czynników, dlatego mogą występować różnice w fakturze i barwie co nie stanowi wady produktu i nie wpływa na jego jakość, trwałość i funkcjonalność.

Listwy drewniane mogą ujawniać niewielkie zmiany w kształcie i wymiarach wywołane specyficznymi warunkami eksploatacji takimi jak: wilgotność, różnice temperatur, etc.

VI

80X 

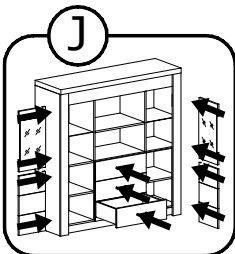
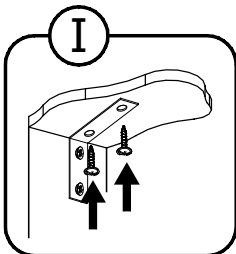
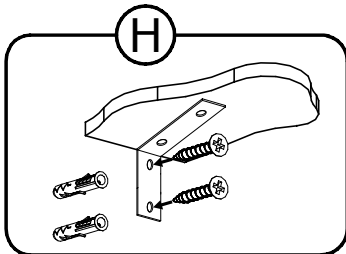
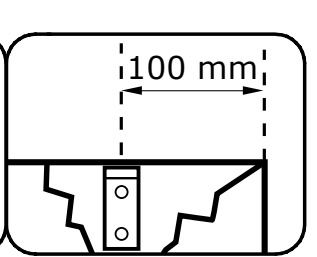
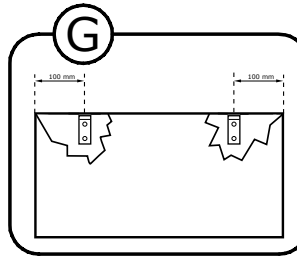
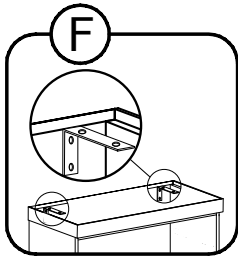
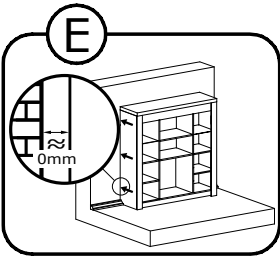
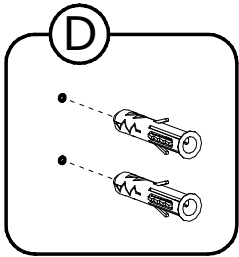
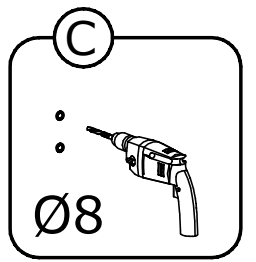
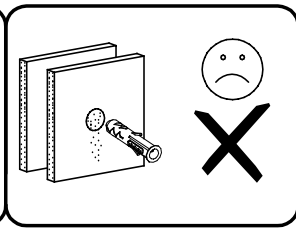
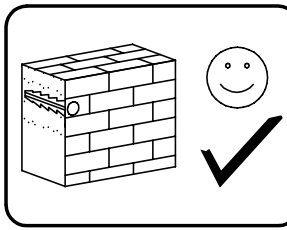
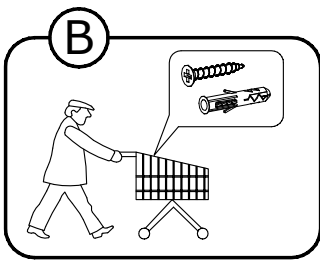
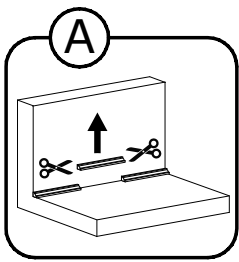
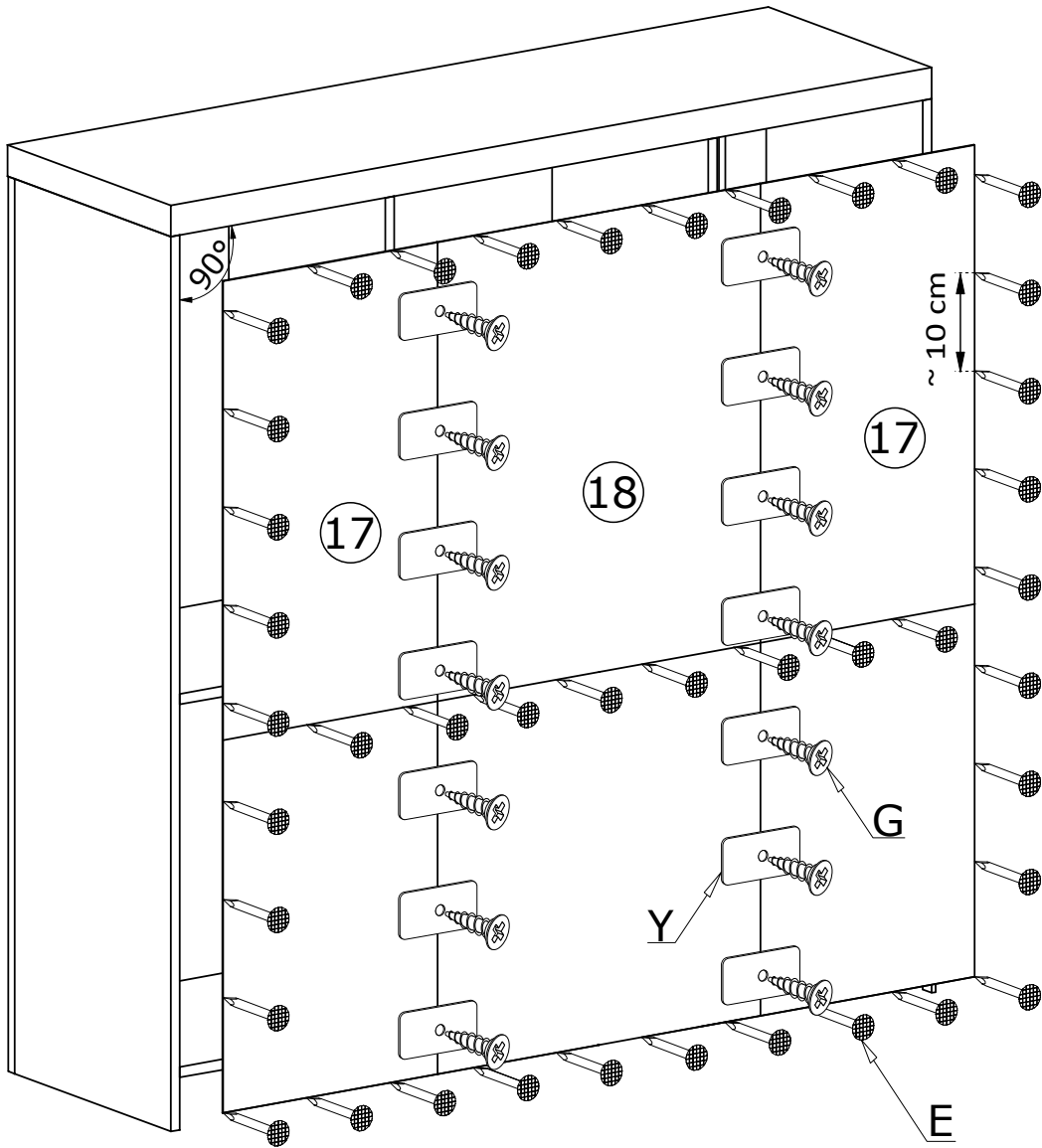

VII

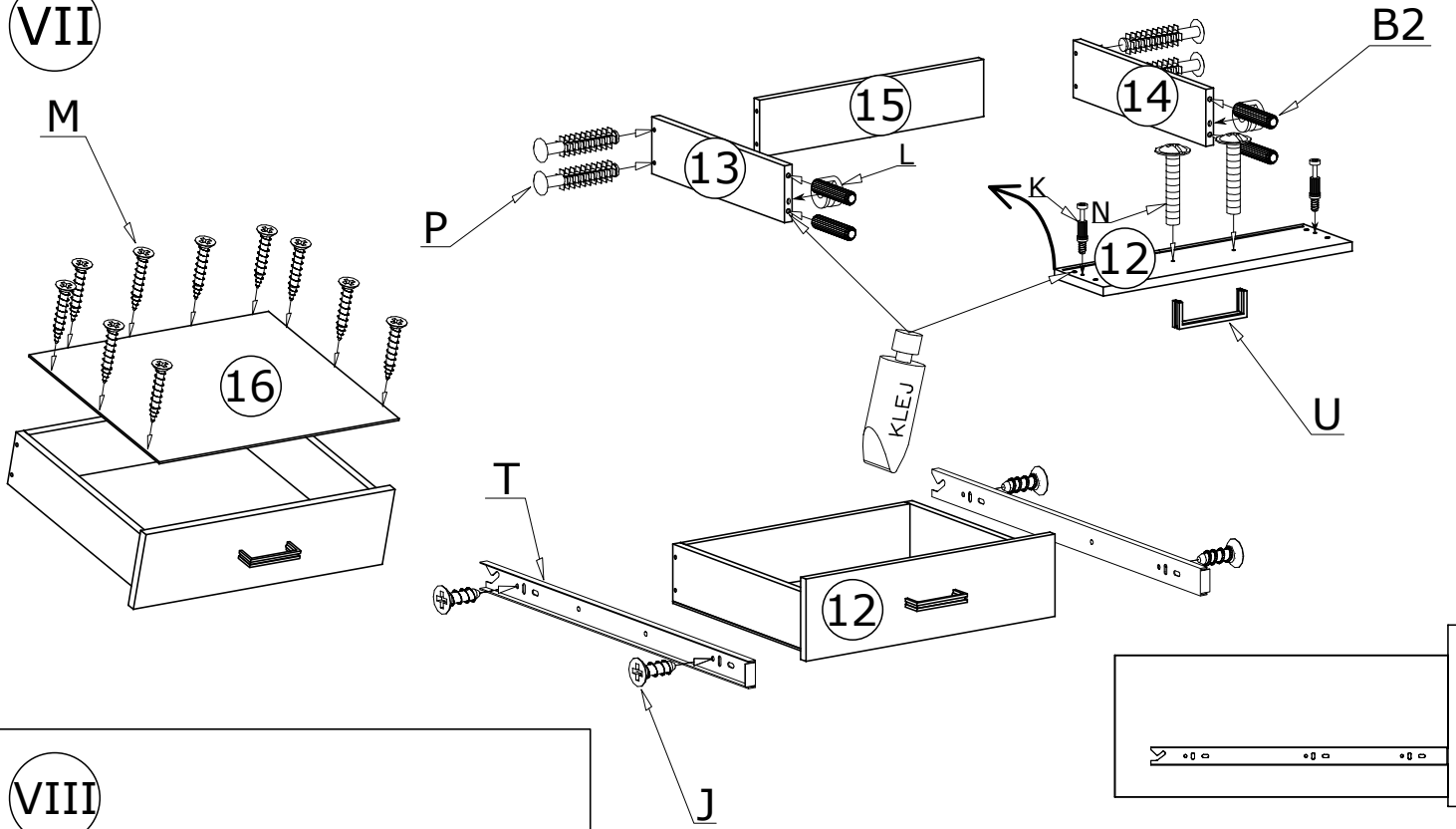

VIII

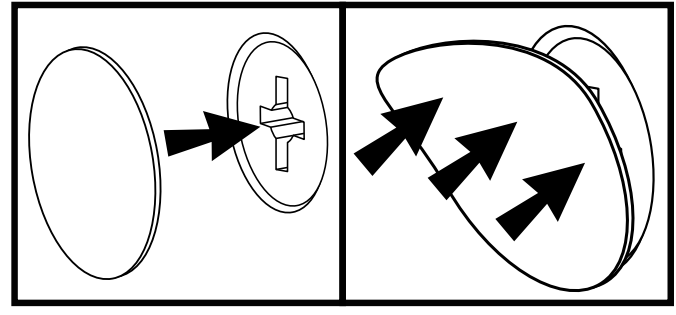
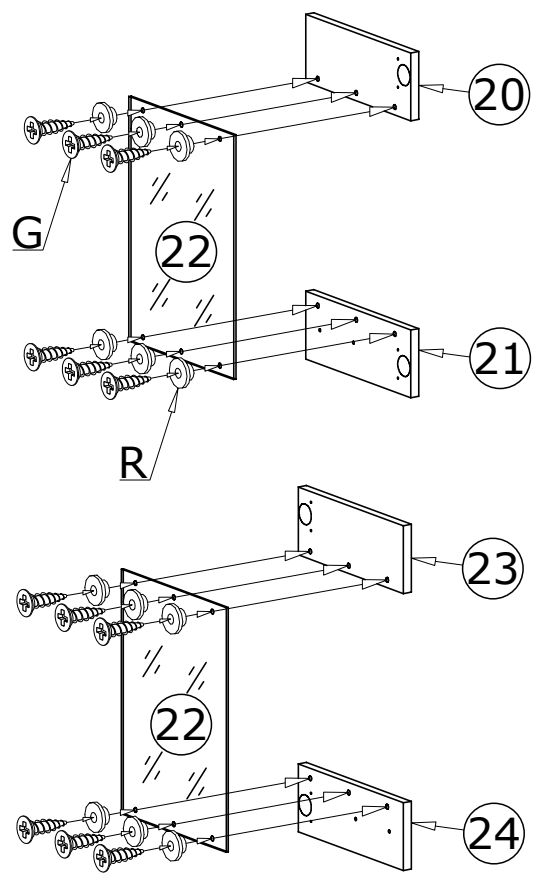

IX

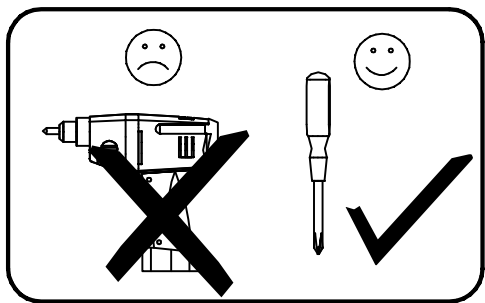
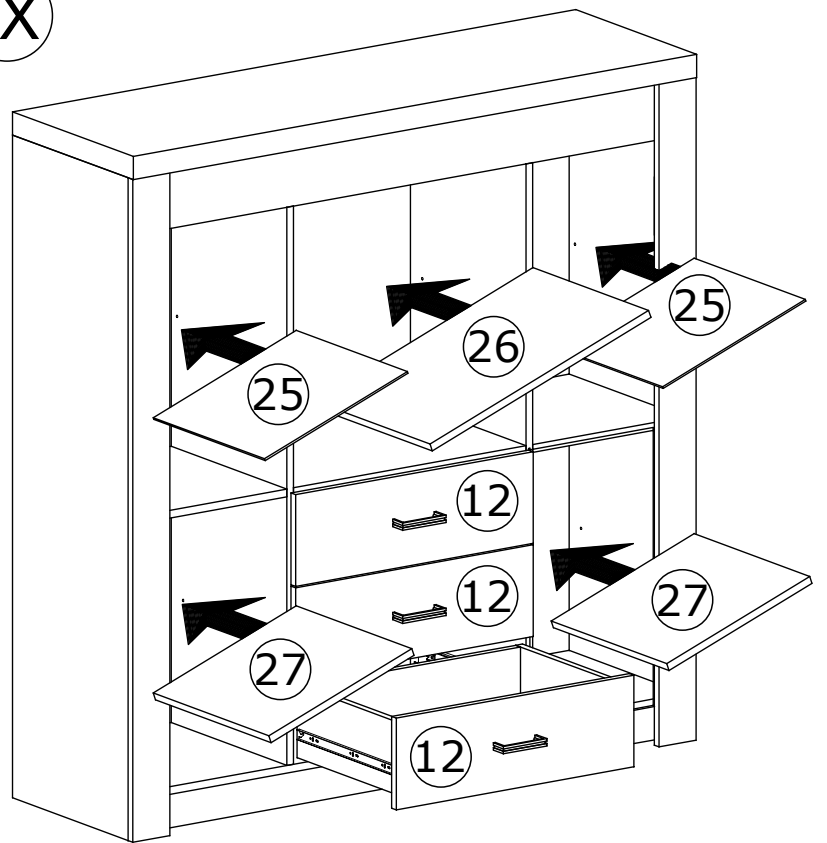

X

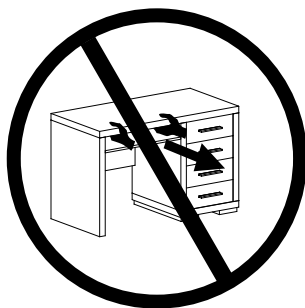
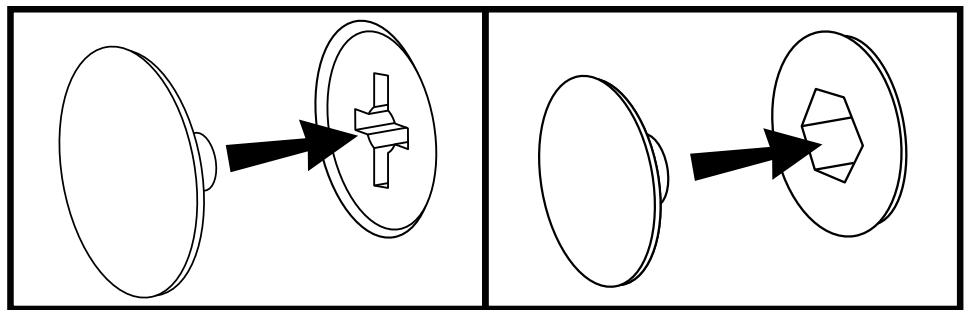
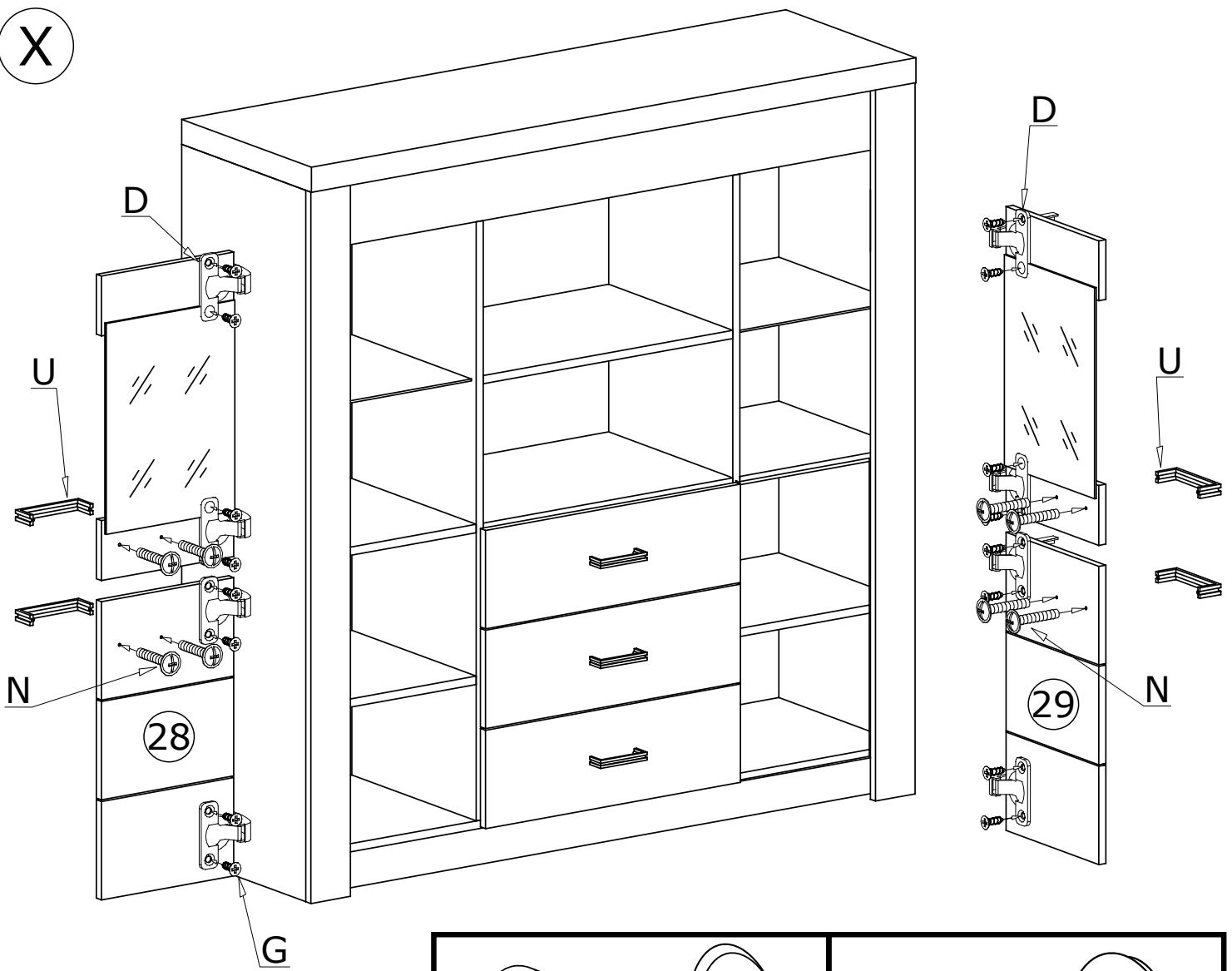

MONTAŻ/DEMONTAŻ PROWADNIC

1



2



3

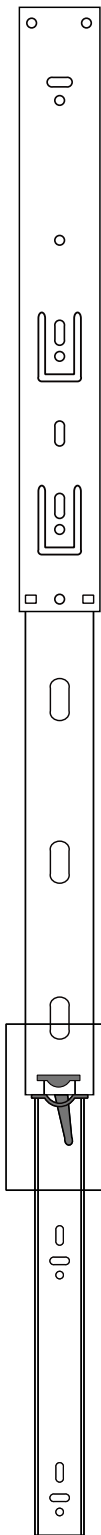

4

