

INDIANAPOLIS 14

Katalogowy

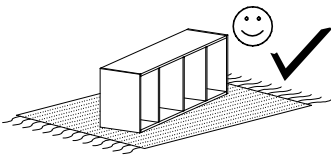

Narzędzia potrzebne do montażu

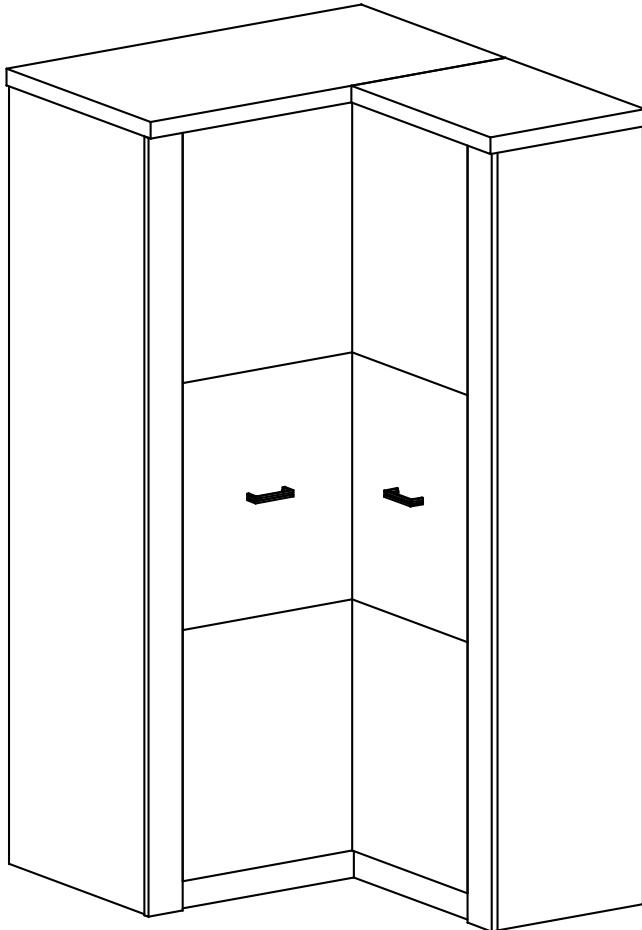
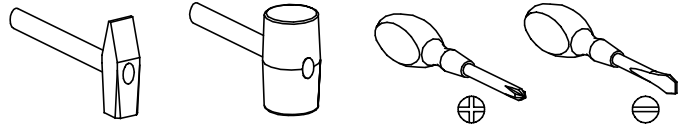

UWAGA !!!

MONTOWANIE USZKODZONYCH
ELEMENTÓW POWODUJE UTRATĘ
GWARANCJI

Nr	D[mm]	S[mm]	G[mm]	Ilość
1	480	422	48	1
2	900	582	48	1
3	886	563	16	1
4	478	402	16	1
5	1870	403	16	1
6	530	80	16	1
7	545	80	16	1
8	1870	563	16	1
9	1773	420	16	1
10	1773	420	16	1
11	868	410	16	1
12	868	80	16	1
13	463	380	16	4
14	1800	890	2,5	1
15	1800	690	2,5	1
16	1780	395	16	1
17	1780	395	16	1
18	1870	80	16	1
19	1870	80	16	1

W przypadku reklamacji proszę podać numer pakowacza znajdujący się na kartonie.

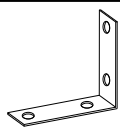

I - 2 St.

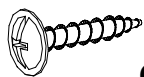

Q - 4 St.
3,5x16 mm

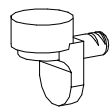

P - 2 St.

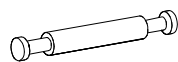

F - 5 St.



R - 1 St.

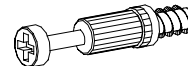

K - 21 Kpl.



B2 - 6 St.

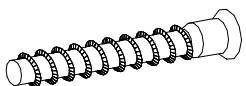

A - 11 St.



O - 8 St.

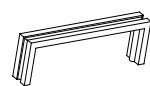

U - 2 St.



Y - 2 St.



S - 20 St.

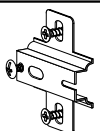

C - 8 St.

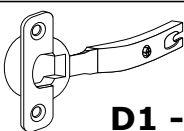

D1 - 4 St.

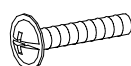

N - 4 St.
4x25 mm

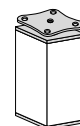

J - 2 St.

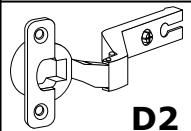

D2 - 4 St.



E - 80 St.



B1 - 26 St.



G - 38 St.
3,5x16 mm

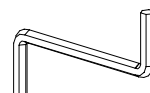

Z - 1 St.



L - 31 St.

I

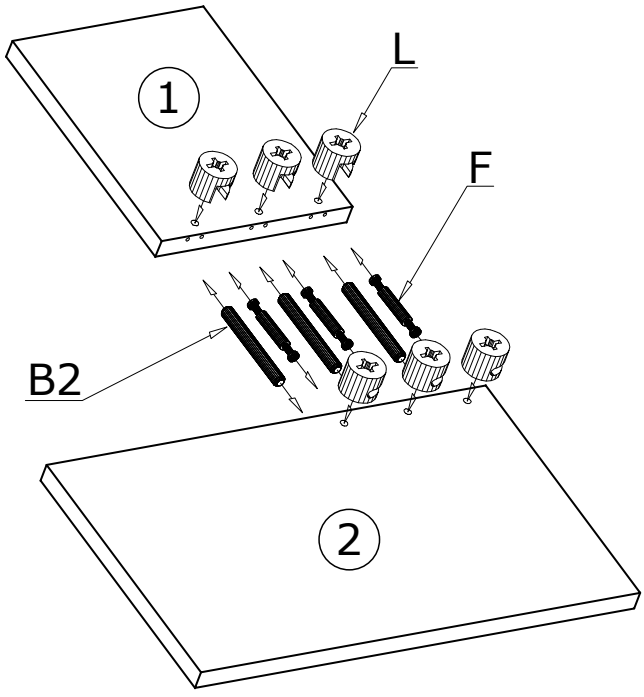

II

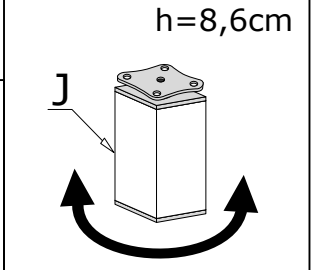
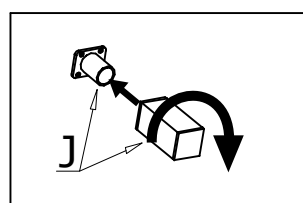
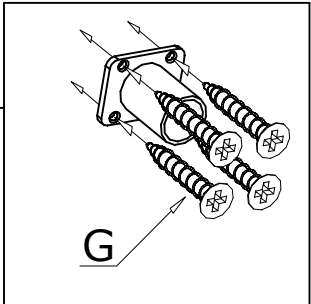
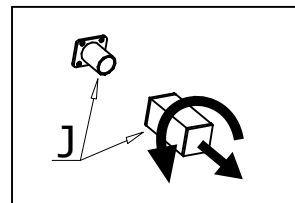
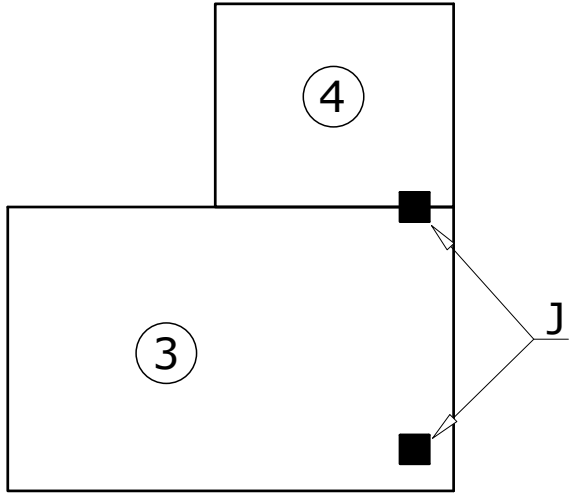
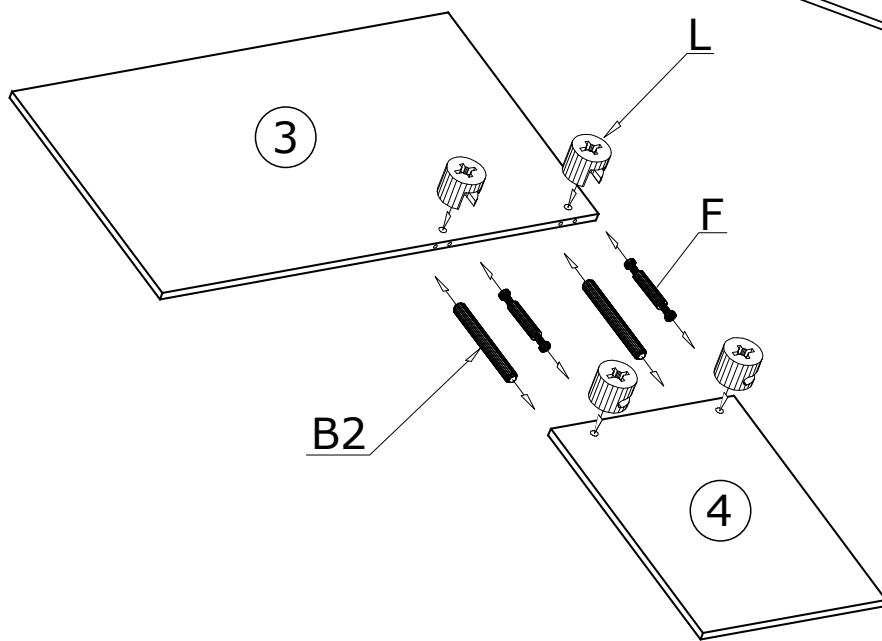
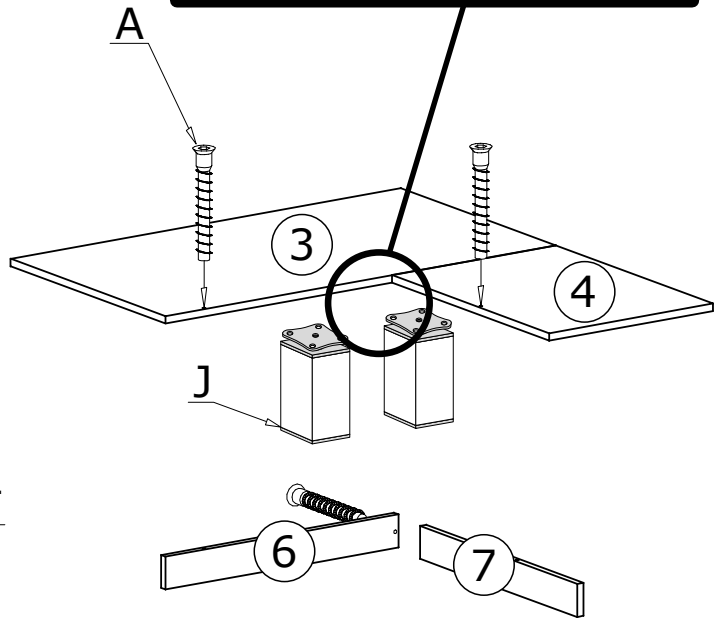
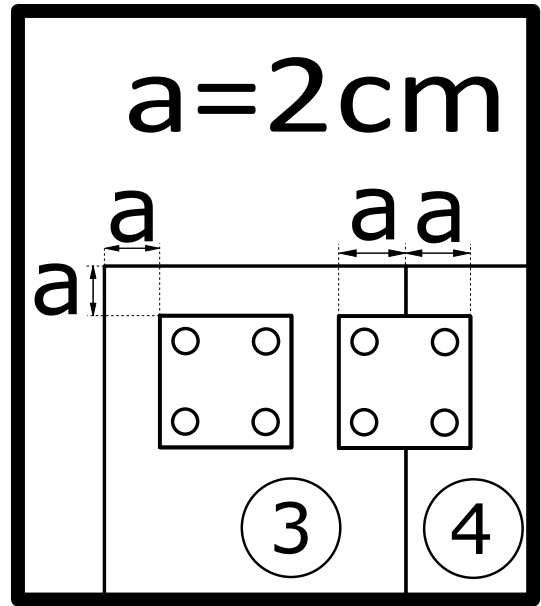

III

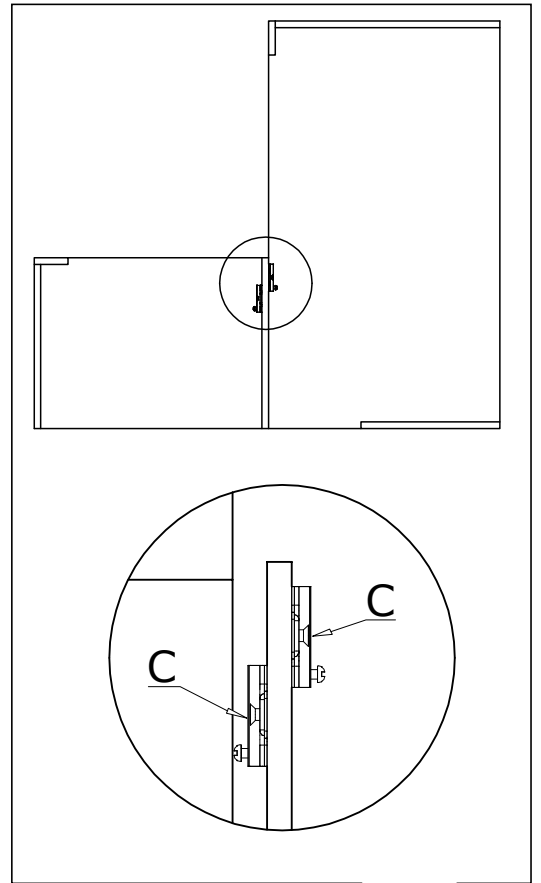
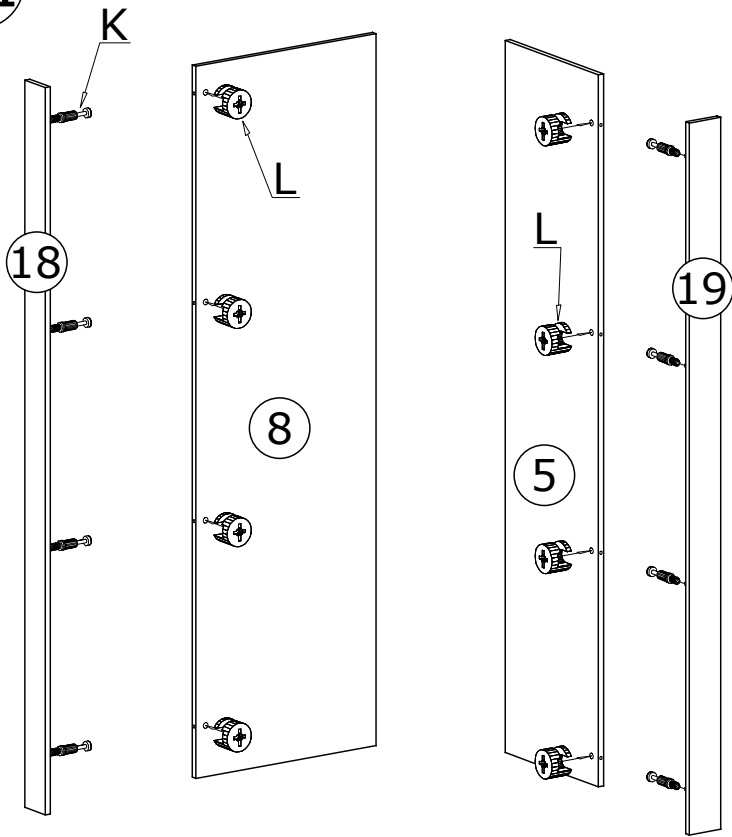

IV

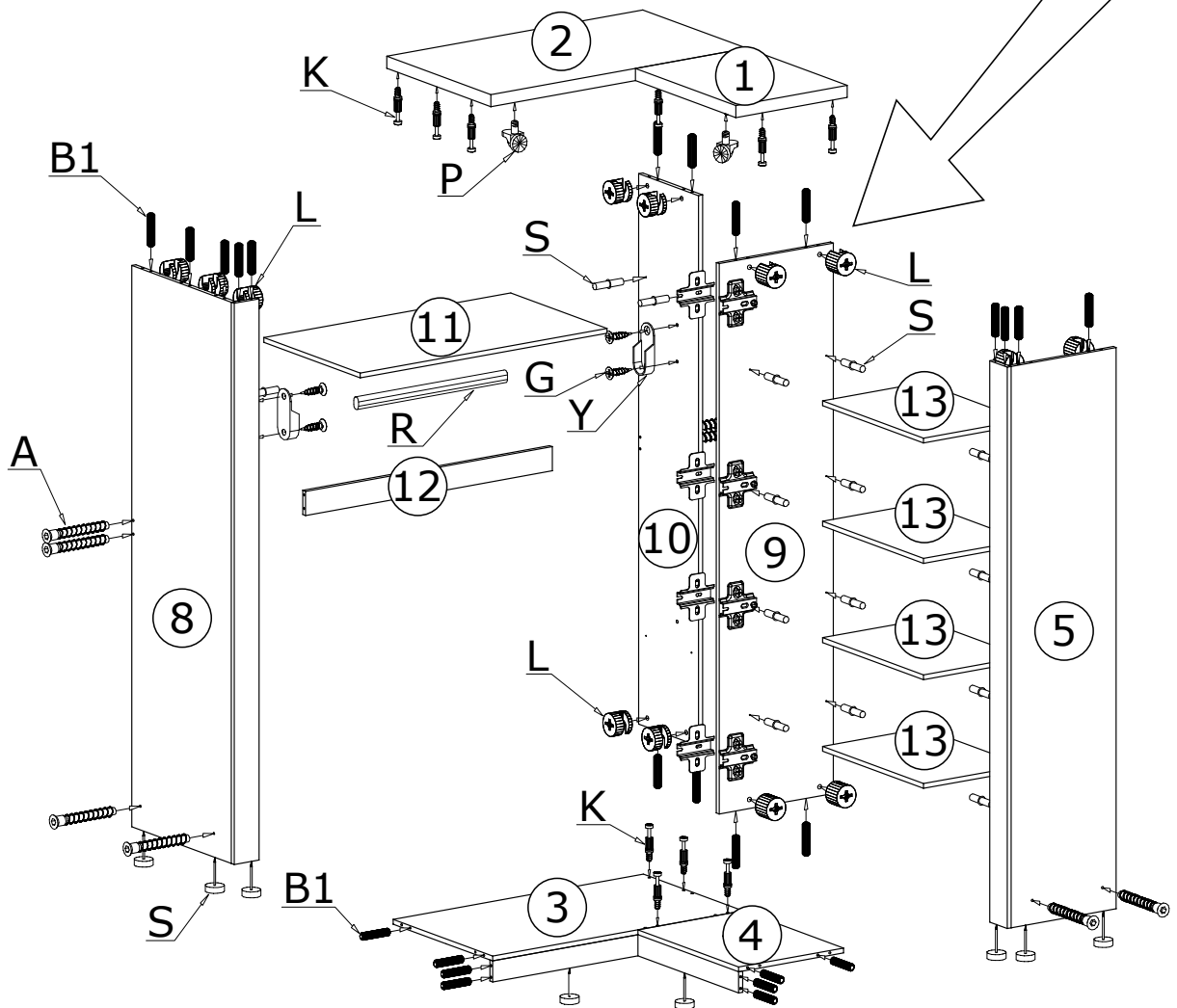

V

80X 

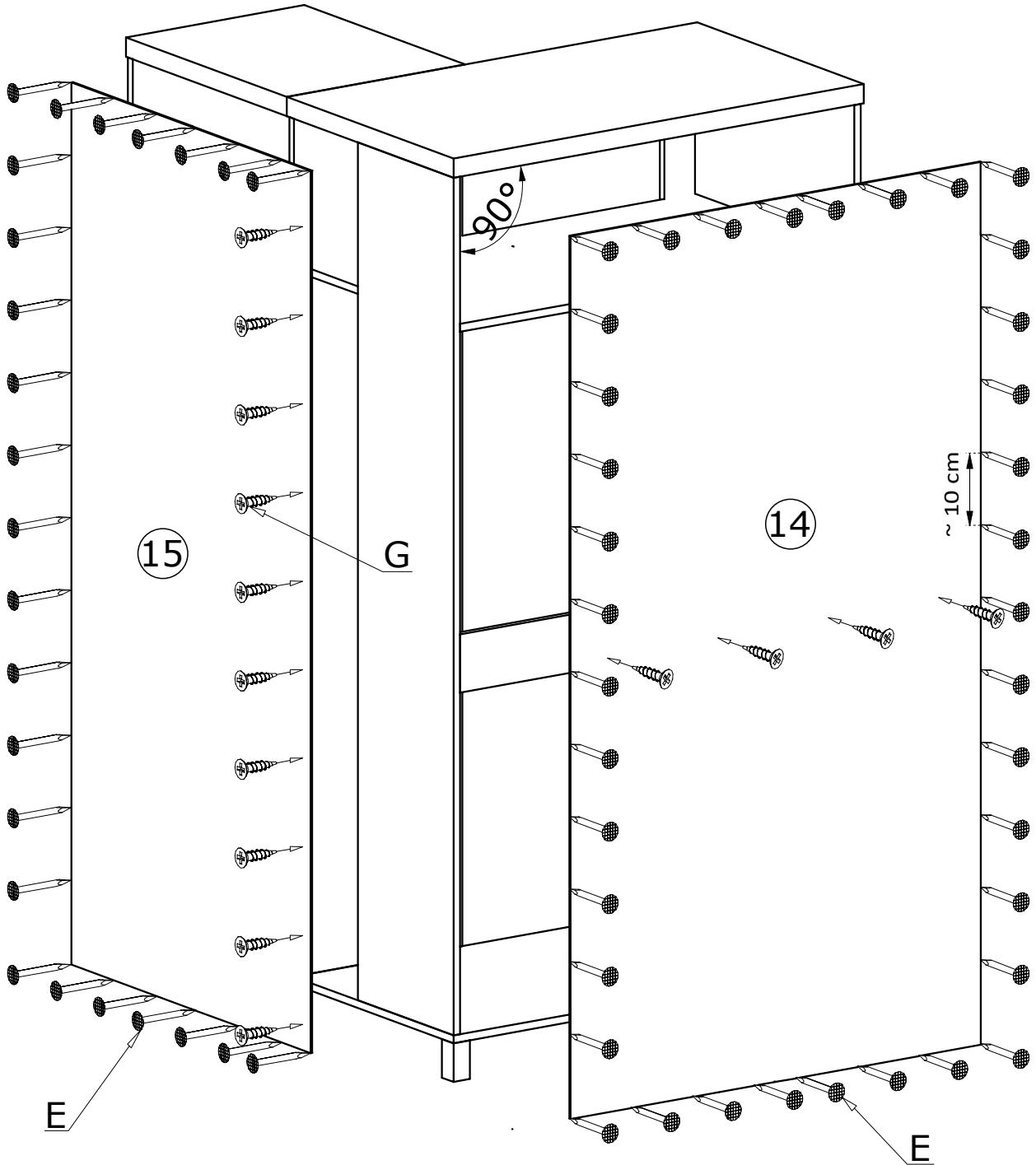

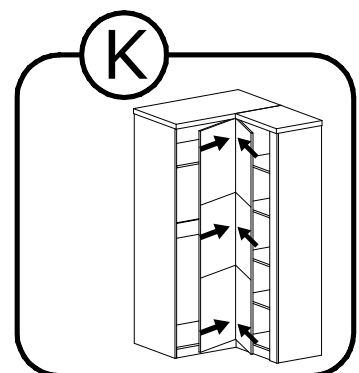
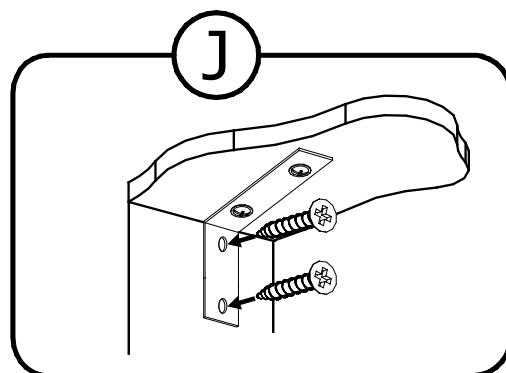
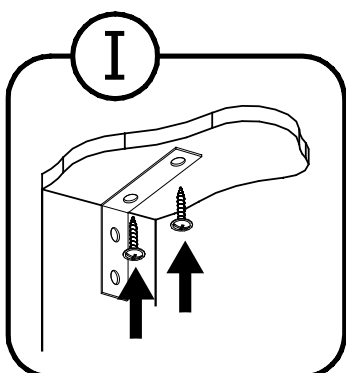
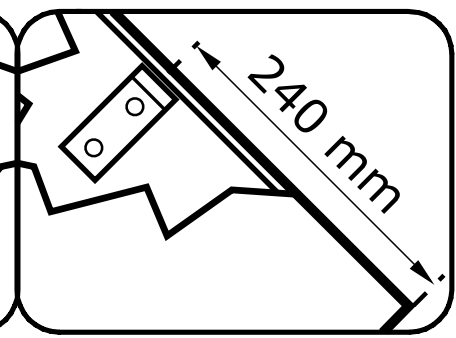
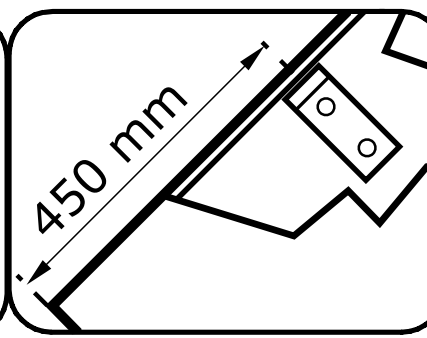
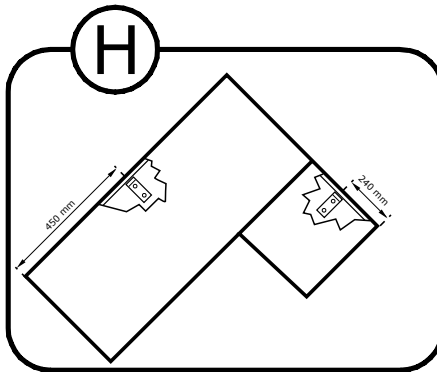
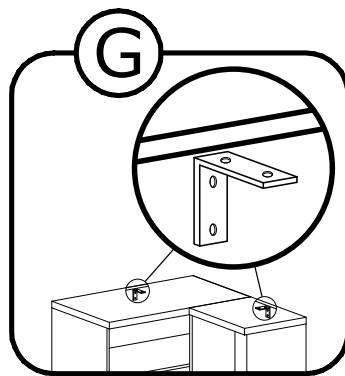
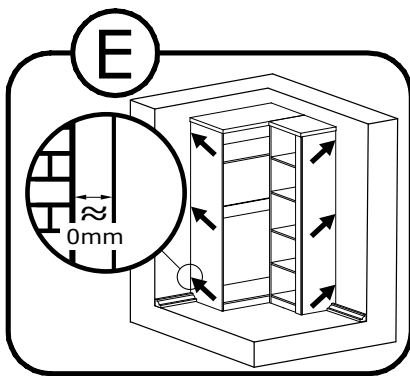
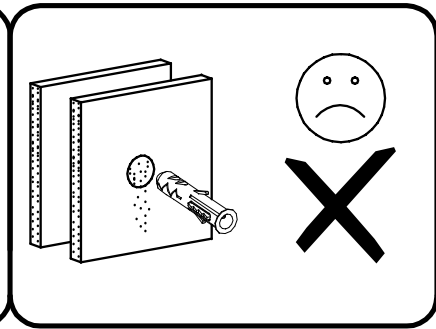
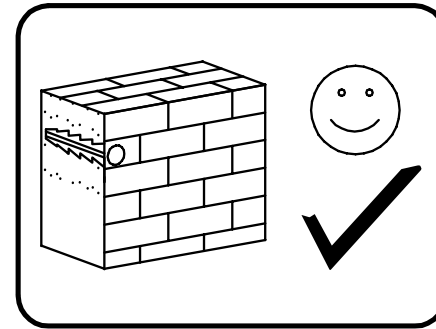
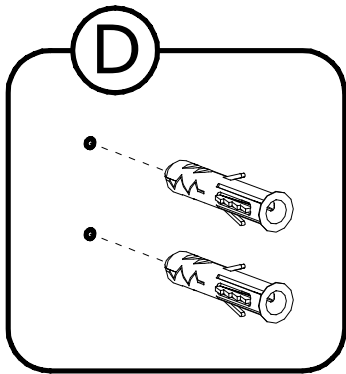
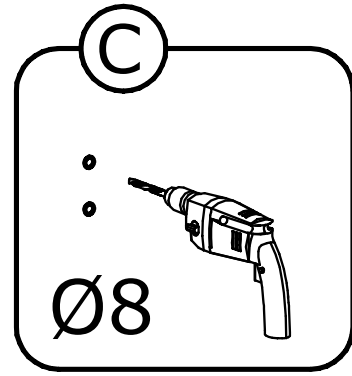
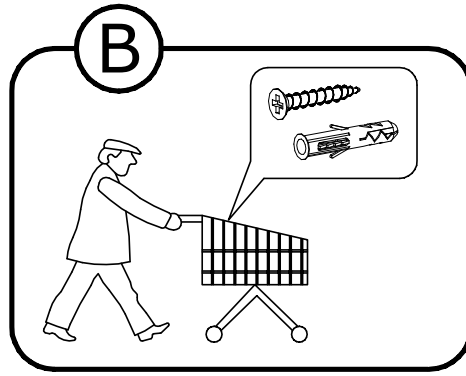
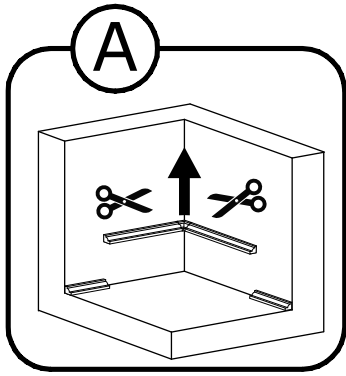

VI

